

Herstal



Herstal[®]
REG. TRADE MARK

Indholdsfortegnelse / Table of contents / Inhaltsverzeichnis

Pendler / Pendants / Pendeln	1
Kroner / Chandeliers / Kronleuchter	27
Væg, loft / Wall, ceiling / Wand, Decke	33
Bordlamper / Table lamps / Tischleuchten	65
Gulvlamper / Floor lamps / Bodenleuchter	89
Tracks / Tracks / Tracks	117
Badlamper / Bathroom lamps / Badezimmer Leuchten	123
Udendørslamper / Exterior / Draußen	131

PENDLER
PENDANTS
PENDELN

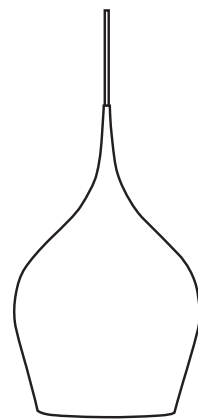









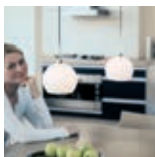

Ballon il grande kit

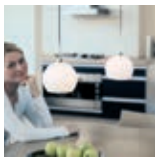
2 pcs. / 2 Stück

Højde (cm) / Height (cm) / Höhe (cm)	10
Diameter (cm) / Diameter (cm) / Durchmesser (cm)	14
Volt / Voltage / Volt	230V-12V
Antal lyskilder / Number of bulbs / Anzahl Birnen	2
Lyskilde / Light source / Licht	35W G4
Ledning / Cable / Kabel	2 X 2,5 m
Pendelophæng / Mountings / Pendelaufhang	2
Kollistr: / Number per package / Stück pro VE	6



- Ledning i sort silicone / Wire in black silicone / Kabel in schwarzem Silikon

	Skærm Shade Schirm	Baldakin Canopy Baldachin	Transformer Transformer Transformer	Dæmper Dimmer Dimmer	Varenr. Item no. Warennr.	EAN-nr. EAN-no. EAN-nr.
	Hvid glas White glass Weiß Glas	 Krom Chrome Chrom	80VA elekt.	På trafo On trafo An Trafo	04045000020	 5 705614 048831
	Hvid glas White glass Weiß Glas	 Krom Chrome Chrom	80VA elekt.	Touch	04045000020T	 5 705614 051428
	Contrast glas Contrast glass Contrast Glas	 Krom Chrome Chrom	80VA elekt.	På trafo On trafo An Trafo	04045000088	 5 705614 095255
	Contrast glas Contrast glass Contrast Glas	 Krom Chrome Chrom	80VA elekt.	Touch	0404500088T	 5 705614 095248

Batt pendel

Pendant / Pendel

Højde (cm) / Height (cm) / Höhe (cm)	80
Diameter (cm) / Diameter (cm) / Durchmesser (cm)	5
Volt / Voltage / Volt	230V-12V
Antal lyskilder / Number of bulbs / Anzahl Birnen	1
Lyskilde / Light source / Licht	35W MRI 6
Ledning / Cable / Kabel	2 m
Kollistr: / Number per package / Stück pro VE	4

- Ledning i klar PVC / Cable in clear PVC / Kabel in klares PVC



	Skærm Shade Schirm	Baldakin Canopy Baldachin	Transformer Transformer Transformer	Dæmper Dimmer Dimmer	Varenr: Item no. Warennr.	EAN-nr: EAN-no. EAN-nr.
	Sort metal Black metal Schwarz Metall	 Krom Chrome Chrom	60VA elekt.	— — —	06021160005	 5 705614 107941
	Hvid metal White metal Weiß Metall	 Krom Chrome Chrom	60VA elekt.	— — —	06021160020	 5 705614 107958

Cole 2 pendel











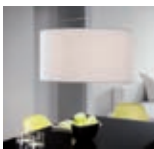

Pendant / Pendel

Højde (cm) / Height (cm) / Höhe (cm)	25
Diameter (cm) / Diameter (cm) / Durchmesser (cm)	50
Volt / Voltage / Volt	230V
Antal lyskilder / Number of bulbs / Anzahl Birnen	3
Lyskilde / Light source / Licht	40W E14
Alt. lyskilde / Alt. Light source / Alternativ Licht	7-9W E14 CFL
Ledning / Cable / Kabel	2 m
Kollistr: / Number per package / Stück pro VE	2

- Ledning i grå tekstil / Cable in grey textile / Kabel in grauen Textil
- Lampen leveres ekskl. lyskilde / Bulb not included / Exklusiv Birne
- Lukket i top og har matteret glasplade i bunden / Closed top and matt glass plate bottom / Oben geschlossen und mattiert Glasplatte unten



Cole bord, gulv og loftlamper, se side 35, 66-69, 94-97
 Cole table, floor and ceiling lamps, see page 35, 66-69, 94-97
 Cole Tisch, Boden und Deckleuchten, siehe Seite 35, 66-69, 94-97

	Skærm i tekstil Shade textile Schirm Textil	Baldakin Canopy Baldachin	Transformer Transformer Transformer	Dæmper Dimmer Dimmer	Varenr: Item no. Warennr.	EAN-nr: EAN-no. EAN-nr.
	Hvid White Weiß	 Krom Chrome Chrom	— — —	— — —	06094520120	 5 705614 103196
	Sort contrast Black contrast Schwarz contrast	 Krom Chrome Chrom	— — —	— — —	06094520173	 5 705614 103202
	Hvid plissé White pleat Weiß Plissee	 Krom Chrome Chrom	— — —	— — —	06094520020	 5 705614 104223
	Sort plissé Black pleat Schwarz Plissee	 Krom Chrome Chrom	— — —	— — —	06094520105	 5 705614 105336

Cole 65/75 pendel

Pendant / Pendel

Højde (cm) / Height (cm) / Höhe (cm)	26/34
Diameter (cm) / Diameter (cm) / Durchmesser (cm)	65/75
Volt / Voltage / Volt	230V
Antal lyskilder / Number of bulbs / Anzahl Birnen	3
Lyskilde / Light source / Licht	60W E27
Alt. lyskilde / Alt. Light source / Alternativ Licht	11-13W E27 CFL
Ledning / Cable / Kabel	2 m
Kollistr. / Number per package / Stück pro VE	2

- Ledning i grå tekstil / Cable in grey textile / Kabel in grauen Textil
- Lampen leveres eksl. lyskilde / Bulb not included / Exclusiv Birne
- Lukket i top og har matteret glasplade i bunden / Closed top and matt glass plate bottom / Oben geschlossen und mattiert Glasplatte unten



Cole bord, gulv og loftlamper, se side 35, 66-69, 94-97

Cole table, floor and ceiling lamps, see page 35, 66-69, 94-97

Cole Tisch, Boden und Deckleuchten, siehe Seite 35, 66-69, 94-97

	Skærm i tekstil Shade textile Schirm Textil	Baldakin Canopy Baldachin	Transformer Transformer Transformer	Dæmper Dimmer Dimmer	Varenr: Item no. Warennr.	EAN-nr: EAN-no. EAN-nr.
 Cole 65 pendel	Hvid plissé White pleat Weiß Plissee	 Krom Chrome Chrom	— — —	— — —	06094650120	 5 705614 090359
 Cole 75 pendel	Hvid plissé White pleat Weiß Plissee	 Krom Chrome Chrom	— — —	— — —	06094750120	 5 705614 095439



Diritto pendel

Pendant / Pendel

Højde (cm) / Height (cm) / Höhe (cm)	39
Diameter (cm) / Diameter (cm) / Durchmesser (cm)	15
Volt / Voltage / Volt	230V
Antal lyskilder / Number of bulbs / Anzahl Birnen	1
Lyskilde / Light source / Licht	60W E27
Alt. lyskilde / Alt. Light source / Alternativ Licht	11-13W E27 CFL
Ledning / Cable / Kabel	2 m
Kollistr: / Number per package / Stück pro VE	6

- Ledning i sort PVC / Cable in black PVC / Kabel in schwarzem PVC
- Lampen leveres ekskl. lyskilde / Bulb not included / Exklusiv Birne



	Skærm Shade Schirm	Baldakin Canopy Baldachin	Transformer Transformer Transformer	Dæmper Dimmer Dimmer	Varenr: Item no. Warennr.	EAN-nr: EAN-no. EAN-nr.
	Hvid glas White glass Weiß Glas	 Krom Chrome Chrom	— — —	— — —	06056270020	 5 705614 101086

Dive pendel



Pendant / Pendel

Højde (cm) / Height (cm) / Höhe (cm)	15
Diameter (cm) / Diameter (cm) / Durchmesser (cm)	15
Volt / Voltage / Volt	230V
Antal lyskilder / Number of bulbs / Anzahl Birnen	1
Lyskilde / Light source / Licht	40W E14
Alt. lyskilde / Alt. Light source / Alternativ Licht	7-9W E14 CFL
Ledning / Cable / Kabel	2 m
Kollistr. / Number per package / Stück pro VE	6

- Ledning i sort PVC / Cable in black PVC / Kabel in schwarzem PVC
- Lampen leveres ekskl. lyskilde / Bulb not included / Exklusiv Birne

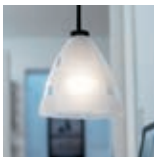

Dive væg og skinne, se side 40-41, 121
Dive wall and track, see page 40-41, 121
Dive Wandleuchte, siehe Seite 40-41, 121

	Skærm i glas Shade glass Schirm Glas	Baldakin Canopy Baldachin	Transformer Transformer Transformer	Dæmper Dimmer Dimmer	Varenr. Item no. Warennr.	EAN-nr. EAN-no. EAN-nr.
	Klar & frosted Clear & frosted Klar & frosted	 Sort Black Schwarz	- - -	- - -	06093140539	 5 705614 099161

Dive Trio pendel



Pendant / Pendel

Højde (cm) / Height (cm) / Höhe (cm)	Max. 100
Diameter (cm) / Diameter (cm) / Durchmesser (cm)	15
Volt / Voltage / Volt	230V
Antal lyskilder / Number of bulbs / Anzahl Birnen	3
Lyskilde / Light source / Licht	40W E14
Alt. lyskilde / Alt. Light source / Alternativ Licht	7-9W E14 CFL
Ledning / Cable / Kabel	1,5 m
Kollistr. / Number per package / Stück pro VE	4

- Ledning i klar PVC / Cable in clear PVC / Kabel in klares PVC
- Lampen leveres ekskl. lyskilde / Bulb not included / Exklusiv Birne



Dive væg og skinne, se side 40-41, 121
Dive wall and track, see page 40-41, 121
Dive Wandleuchte, siehe Seite 40-41, 121

	Skærm i glas Shade glass Schirm Glas	Baldakin Canopy Baldachin	Transformer Transformer Transformer	Dæmper Dimmer Dimmer	Varenr. Item no. Warennr.	EAN-nr. EAN-no. EAN-nr.
	Klar & frosted Clear & frosted Klar & frosted	 Krom Chrome Chrom	- - -	- - -	06093143139	 5 705614 108078





Drop pendel medium

Pendant medium / Pendel medium

Højde (cm) / Height (cm) / Höhe (cm)	35
Diameter (cm) / Diameter (cm) / Durchmesser (cm)	20
Volt / Voltage / Volt	230V
Antal lyskilder / Number of bulbs / Anzahl Birnen	1
Lyskilde / Light source / Licht	60W E27
Alt. lyskilde / Alt. Light source / Alternativ Licht	11-13W E27 CFL
Ledning / Cable / Kabel	2,5 m
Kollistr: / Number per package / Stück pro VE	2

- Lampen leveres ekskl. lyskilde / Bulb not included / Exklusiv Birne
- Lampen leveres med henholdsvis grå og sort stofledning / The lamp comes with, respectively grey or black textile cable / Die Lampe wird mit jeweils grauen und schwarzen Stoff-Kabel geliefert



	Skærm Shade Schirm	Baldakin Canopy Baldachin	Transformer Transformer Transformer	Dæmper Dimmer Dimmer	Varenr: Item no. Warennr.	EAN-nr: EAN-no. EAN-nr.
	Sort metal Black metal Schwarz Metall	 Sort metal Black metal Schwarz Metall	– – –	– – –	06058260005	 5 705614 108023
	Hvid metal White metal Weiß Metall	 Hvid metal White metal Weiß Metall	– – –	– – –	06058260020	 5 705614 108030





Drop pendel stor

Pendant large / Pendel groß

Højde (cm) / Height (cm) / Höhe (cm)	45
Diameter (cm) / Diameter (cm) / Durchmesser (cm)	26,5
Volt / Voltage / Volt	230V
Antal lyskilder / Number of bulbs / Anzahl Birnen	1
Lyskilde / Light source / Licht	60W E27
Alt. lyskilde / Alt. Light source / Alternativ Licht	11-13W E27 CFL
Ledning / Cable / Kabel	2,5 m
Kollistr: / Number per package / Stück pro VE	2

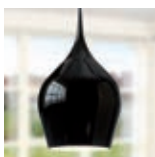
- Lampen leveres ekskl. lyskilde / Bulb not included / Exklusiv Birne
- Lampen leveres med henholdsvis grå og sort stofledning / The lamp comes with, respectively grey or black textile cable / Die Lampe wird mit jeweils grauen und schwarzen Stoff-Kabel geliefert

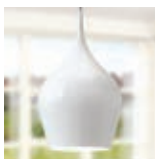

	Skærm Shade Schirm	Baldakin Canopy Baldachin	Transformer Transformer Transformer	Dæmper Dimmer Dimmer	Varenr: Item no. Warennr.	EAN-nr: EAN-no. EAN-nr.
	Sort metal Black metal Schwarz Metall	 Sort metal Black metal Schwarz Metall	– – –	– – –	06058270005	 5 705614 107798
	Hvid metal White metal Weiß Metall	 Hvid metal White metal Weiß Metall	– – –	– – –	06058270020	 5 705614 107828

Grass pendel

Pendant / Pendel

Højde (cm) / Height (cm) / Höhe (cm)	30
Diameter (cm) / Diameter (cm) / Durchmesser (cm)	50
Volt / Voltage / Volt	230V
Antal lyskilder / Number of bulbs / Anzahl Birnen	1
Lyskilde / Light source / Licht	100W E27 Globe 120
Alt. lyskilde / Alt. Light source / Alternativ Licht	23W E27 CFL
Ledning / Cable / Kabel	2,5 m
Kollistr. / Number per package / Stück pro VE	2



- Ledning i grå tekstil / Cable in grey textile / Kabel in grauen Textil
- Lampen leveres ekskl. lyskilde / Bulb not included / Exklusiv Birne

Grass gulv, se side 99

Grass floor, see page 99

Grass bodenleuchte, siehe Seite 99

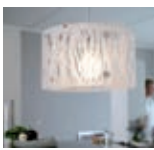

	Skærm Shade Schirm	Baldakin Canopy Baldachin	Transformer Transformer Transformer	Dæmper Dimmer Dimmer	Varenr: Item no. Warennr.	EAN-nr: EAN-no. EAN-nr.
	Frosted akryl Frosted acrylic Frostet Acryl	 Krom Chrome Chrom	– – –	– – –	06087270120	 5 705614 098324



Granat pendel

Pendant / Pendel

Højde (cm) / Height (cm) / Höhe (cm)	24,5
Diameter (cm) / Diameter (cm) / Durchmesser (cm)	14
Volt / Voltage / Volt	230V
Antal lyskilder / Number of bulbs / Anzahl Birnen	1
Lyskilde / Light source / Licht	60W E27
Alt. lyskilde / Alt. Light source / Alternativ Licht	23W E27 CFL
Ledning / Cable / Kabel	2,5 m
Kollistr. / Number per package / Stück pro VE	6

- Lampen leveres ekskl. lyskilde / Bulb not included / Exklusiv Birne
- Ledning i sort PVC / Cable in black PVC / Kabel in schwarzes PVC

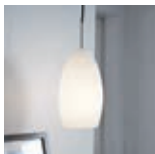

	Skærm Shade Schirm	Baldakin Canopy Baldachin	Transformer Transformer Transformer	Dæmper Dimmer Dimmer	Varenr: Item no. Warennr.	EAN-nr: EAN-no. EAN-nr.
	Hvid glas White glass Weiß Glas	▽ Sort plast Black plastic Schwarz Kunststoff	- - -	- - -	06066270020	 5 705614 102588

Kelby 25 pendel





Pendant / Pendel

Højde (cm) / Height (cm) / Höhe (cm)	20
Diameter (cm) / Diameter (cm) / Durchmesser (cm)	25
Volt / Voltage / Volt	230V
Antal lyskilder / Number of bulbs / Anzahl Birnen	1
Lyskilde / Light source / Licht	Max 100W E27
Alt. lyskilde / Alt. Light source / Alternativ Licht	23W E27 CFL
Ledning / Cable / Kabel	2,5 m
Kollistr.: / Number per package / Stück pro VE	4

- Lampen leveres ekskl. lyskilde / Bulb not included / Exklusiv Birne
- Lampen leveres med henholdsvis grå og sort stofledning / The lamp comes with, respectively grey or black textile cable / Die Lampe wird mit jeweils grauen und schwarzen Stoff-Kabel geliefert

Kelby bad, gulv og væglampe samt skinner, se side 46-47, 102, 110, 118, 126-128
 Kelby bathroom, floor, walllamps and tracks, see page 46-47, 102, 110, 118, 126-128
 Kelby badezimmer, boden, wandleuchte und tracks, siehe Seite 46-47, 102, 110, 118, 126-128



	Skærm Shade Schirm	Baldakin Canopy Baldachin	Transformer Transformer Transformer	Dæmper Dimmer Dimmer	Varenr: Item no. Warennr.	EAN-nr: EAN-no. EAN-nr.
	Sort glas Black glass Schwarz Glas	 Krom Chrome Chrom	– – –	– – –	06017250005	 5 705614 100287
	Hvid glas White glass Weiß Glas	 Krom Chrome Chrom	– – –	– – –	06017250020	 5 705614 100294

Kelby 32 pendel









Pendant / Pendel

Højde (cm) / Height (cm) / Höhe (cm)	25
Diameter (cm) / Diameter (cm) / Durchmesser (cm)	32
Volt / Voltage / Volt	230V
Antal lyskilder / Number of bulbs / Anzahl Birnen	1
Lyskilde / Light source / Licht	Max 100W E27
Alt. lyskilde / Alt. Light source / Alternativ Licht	23W E27 CFL
Ledning / Cable / Kabel	2,5 m
Kollistr: / Number per package / Stück pro VE	2

- Lampen leveres ekskl. lyskilde / Bulb not included / Exklusiv Birne
- Kelby sort leveres med sort stofledning / Kelby black comes with black textilecable / Kelby schwarz wird schwarzen Stoff-Kabel geliefert
- Kelby sort/lime og sort/orange leveres med henholdsvis lime og orange stofledning / Kelby black/lime and black/orange comes with, respectively lime or orange textilecable / Kelby schwarz/lime und schwarz/orange wird mit jeweils lime und orangem Stoff-Kabel geliefert



Kelby bad, gulv og væglampe samt skinner, se side 46-47, 102, 110, 118, 126-128
 Kelby bathroom, floor, walllamps and tracks, see page 46-47, 102, 110, 118, 126-128
 Kelby badezimmer, boden, wandleuchte und tracks, siehe Seite 46-47, 102, 110, 118, 126-128

	Skærm glas Shade glass Schirm Glas	Baldakin Canopy Baldachin	Transformer Transformer Transformer	Dæmper Dimmer Dimmer	Varenr: Item no. Warennr.	EAN-nr: EAN-no. EAN-nr.
	Sort Black Schwarz	 Krom Chrome Chrom	– – –	– – –	06017320005	 5 705614 100270
	Sort / orange Black / orange Schwarz / orange	 Krom Chrome Chrom	– – –	– – –	06017320030	 5 705614 101178
	Sort / lime Black / lime Schwarz / limette	 Krom Chrome Chrom	– – –	– – –	06017320053	 5 705614 101161

Kelby 40 pendel



Pendant / Pendel

Højde (cm) / Height (cm) / Höhe (cm)	33
Diameter (cm) / Diameter (cm) / Durchmesser (cm)	40
Volt / Voltage / Volt	230V
Antal lyskilder / Number of bulbs / Anzahl Birnen	1
Lyskilde / Light source / Licht	Max 100W E27
Alt. lyskilde / Alt. Light source / Alternativ Licht	23W E27 CFL
Ledning / Cable / Kabel	2,5 m
Kollistr: / Number per package / Stück pro VE	2

- Lampen leveres ekskl. lyskilde / Bulb not included / Exklusiv Birne
- Lampen leveres med sort stofledning / The lamp comes with, black textile cable / Die Lampe wird mit schwarzen Stoff-Kabel geliefert

Kelby bad, gulv og væglampe samt skinner, se side 46-47, 102, 110, 118, 126-128
 Kelby bathroom, floor, walllamps and tracks, see page 46-47, 102, 110, 118, 126-128
 Kelby badezimmer, boden, wandleuchte und tracks, siehe Seite 46-47, 102, 110, 118, 126-128



	Skærm Shade Schirm	Baldakin Canopy Baldachin	Transformer Transformer Transformer	Dæmper Dimmer Dimmer	Varenr: Item no. Warennr.	EAN-nr: EAN-no. EAN-nr.
	Sort glas Black glass Schwarz Glas	 Krom Chrome Chrom	– – –	– – –	06017400005	 5 705614 100256







Maxi Dove pendel

Pendant / Pendel

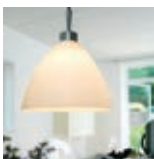
Højde (cm) / Height (cm) / Höhe (cm)	22
Diameter (cm) / Diameter (cm) / Durchmesser (cm)	30
Volt / Voltage / Volt	230V
Antal lyskilder / Number of bulbs / Anzahl Birnen	1
Lyskilde / Light source / Licht	60W E27
Alt. lyskilde / Alt. Light source / Alternativ Licht	11-13W E27 CFL
Ledning / Cable / Kabel	2,5 m
Kollistr.: / Number per package / Stück pro VE	4

- Lampen leveres ekskl. lyskilde / Bulb not included / Exklusiv Birne
- Ledning i sort PVC / Cable in black PVC / Kabel in schwarzes PVC

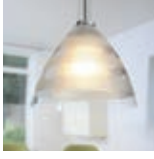

	Skærm glas Shade glass Schirm Glas	Baldakin Canopy Baldachin	Transformer Transformer Transformer	Dæmper Dimmer Dimmer	Varenr: Item no. Warennr.	EAN-nr: EAN-no. EAN-nr.
	Hvid White Weiß	▽ Krom Chrome Chrom	- - -	- - -	06053020020	 5 705614 048282
	Contrast Contrast Contrast	▽ Krom Chrome Chrom	- - -	- - -	06053020088	 5 705614 096283
	Klar / frosted Clear / frosted Klar / frosted	▽ Krom Chrome Chrom	- - -	- - -	06053102525	 5 705614 098713

Mega Dove pendel

Pendant / Pendel

Højde (cm) / Height (cm) / Höhe (cm)	16,5
Diameter (cm) / Diameter (cm) / Durchmesser (cm)	16
Volt / Voltage / Volt	230V
Antal lyskilder / Number of bulbs / Anzahl Birnen	1
Lyskilde / Light source / Licht	40W E14
Alt. lyskilde / Alt. Light source / Alternativ Licht	7-9W E14 CFL
Ledning / Cable / Kabel	2,5 m
Kollistr. / Number per package / Stück pro VE	12



- Lampen leveres ekskl. lyskilde / Bulb not included / Exklusiv Birne
- Mega Dove hvid metal leveres med hvid PVC ledning / Mega Dove white metal comes with white PVC cable / Mega Dove weiß wird mit weißes Kunststoffkabel geliefert
- Øvrige Mega Dove pendler leveres med sort PVC ledning / Other Mega Dove pendants comes with black PVC cable / Anderen Mega Dove Pendeln wird mit schwarzem Kunststoffkabel geliefert

	Skærm Shade Schirm	Baldakin Canopy Baldachin	Transformer Transformer Transformer	Dæmper Dimmer Dimmer	Varenr. Item no. Warennr.	EAN-nr. EAN-no. EAN-nr.
	Sort metal Black metal Schwarz Metall	– – –	– – –	– – –	06053010004	 5 705614 105206
	Sort metal Black metal Schwarz Metall	▽ Sort plast Black plastic Schwarz Kunststoff	– – –	– – –	06053010005	 5 705614 105213
	Hvid metal White metal Weiß Metall	– – –	– – –	– – –	06053010006	 5 705614 090618
	Hvid metal White metal Weiß Metall	▽ Hvid plast White plastic Weiß Kunststoff	– – –	– – –	06053010007	 5 705614 105190
	Hvid glas White glass Weiß Glas	– – –	– – –	– – –	06053010020	 5 705614 046318
	Contrast glas Contrast glass Contrast Glas	– – –	– – –	– – –	06053010088	 5 705614 094920

Mini Tube Kit

2 pcs. / 2 Stück

Højde (cm) / Height (cm) / Höhe (cm)	21,5
Diameter (cm) / Diameter (cm) / Durchmesser (cm)	5
Volt / Voltage / Volt	230V
Antal lyskilder / Number of bulbs / Anzahl Birnen	2
Lyskilde / Light source / Licht	40W E14
Alt. lyskilde / Alt. Light source / Alternativ Licht	7-9W E14 CFL
Ledning / Cable / Kabel	2 x 2,5 m
Kollistr.: / Number per package / Stück pro VE	12

- Lampen leveres ekskl. lyskilde / Bulb not included / Exklusiv Birne
- Ledning i sort PVC / Cable in black PVC / Kabel in schwarzem PVC

Tube bordlamper, se side 81-83
 Tube table lamps, see page 81-83
 Tube Tischleuchten, siehe Seite 81-83



	Skærm Shade Schirm	Baldakin Canopy Baldachin	Transformer Transformer Transformer	Dæmper Dimmer Dimmer	Varenr: Item no. Warennr.	EAN-nr: EAN-no. EAN-nr.
	Hvid glas White glass Weiß Glas	–	–	–	04068010020	 5 705614 065562
	Contrast glas Contrast glass Contrast Glas	–	–	–	04068010088	 5 705614 095309

Tube Kit 230V

2 pcs. / 2 Stück

Højde (cm) / Height (cm) / Höhe (cm)	28
Diameter (cm) / Diameter (cm) / Durchmesser (cm)	6,5
Volt / Voltage / Volt	230V
Antal lyskilder / Number of bulbs / Anzahl Birnen	2
Lyskilde / Light source / Licht	40W E14
Alt. lyskilde / Alt. Light source / Alternativ Licht	7-9W E14 CFL
Ledning / Cable / Kabel	2 x 2,5 m
Kollistr. / Number per package / Stück pro VE	12



- Lampen leveres ekskl. lyskilde / Bulb not included / Exklusiv Birne
- Ledning i sort PVC / Cable in black PVC / Kabel in schwarzem PVC

Tube bordlamper, se side 81-83

Tube table lamps, see page 81-83

Tube Tischleuchten, siehe Seite 81-83



	Skærm Shade Schirm	Baldakin Canopy Baldachin	Transformer Transformer Transformer	Dæmper Dimmer Dimmer	Varenr: Item no. Warennr.	EAN-nr: EAN-no. EAN-nr.
	Hvid glas White glass Weiß Glas	–	–	–	04068010021	 5 705614 101383

Pipe pendel

Pendant / Pendel

Højde (cm) / Height (cm) / Höhe (cm)	24
Diameter (cm) / Diameter (cm) / Durchmesser (cm)	8
Volt / Voltage / Volt	230V
Antal lyskilder / Number of bulbs / Anzahl Birnen	1
Lyskilde / Light source / Licht	23W E27 CFL
Ledning / Cable / Kabel	2,5 m
Kollistr: / Number per package / Stück pro VE	6

- Ledning i sort tekstil / Cable in black textile / Kabel in schwarzes Textil
- Lampen leveres ekskl. lyskilde / Bulb not included / Exklusiv Birne



	Skærm Shade Schirm	Baldakin Canopy Baldachin	Transformer Transformer Transformer	Dæmper Dimmer Dimmer	Varenr: Item no. Warennr.	EAN-nr: EAN-no. EAN-nr.
	Hvid metal White metal Weiß Metall	▽ Sort plast Black plastic Schwarz Kunststoff	- - -	- - -	06020270020	 5 705614 107712
	Sort metal Black metal Schwarz Metall	▽ Sort plast Black plastic Schwarz Kunststoff	- - -	- - -	06020270005	 5 705614 107729

Sko II Grande kit

2 pcs. / 2 Stück

Højde (cm) / Height (cm) / Höhe (cm)	9
Diameter (cm) / Diameter (cm) / Durchmesser (cm)	13
Volt / Voltage / Volt	230V-12V
Antal lyskilder / Number of bulbs / Anzahl Birnen	2
Lyskilde / Light source / Licht	35W G4
Ledning / Cable / Kabel	2 x 2,5
Pendelophæng / Mountings / Pendelaufhang	2
Kollistr: / Number per package / Stück pro VE	6

- Ledning i sort silicone / Wire in black silicone / Kabel in schwarzem Silikon



	Skærm Shade Schirm	Baldakin Canopy Baldachin	Transformer Transformer Transformer	Dæmper Dimmer Dimmer	Varenr: Item no. Warennr.	EAN-nr: EAN-no. EAN-nr.
	Hvid glas White glass Weiß Glas	 Krom Chrome Chrom	80VA elect.	På trafo On trafo An Trafo	04032000020X	 5 705614 016199
	Hvid glas White glass Weiß Glas	 Krom Chrome Chrom	80VA touch	Touch	04032000020XT	 5 705614 050193
	Contrast glas Contrast glass Contrast Glas	 Krom Chrome Chrom	80VA elect.	På trafo On trafo An Trafo	04032000088	 5 705614 095293
	Contrast glas Contrast glass Contrast Glas	 Krom Chrome Chrom	80VA touch	Touch	04032000088T	 5 705614 095286

Slope pendel

Pendant / Pendel

Højde (cm) / Height (cm) / Höhe (cm)	22,50
Diameter (cm) / Diameter (cm) / Durchmesser (cm)	42
Volt / Voltage / Volt	230V
Antal lyskilder / Number of bulbs / Anzahl Birnen	3
Lyskilde / Light source / Licht	11W E14 CFL
Ledning / Cable / Kabel	2,5 m
Kollistr: / Number per package / Stück pro VE	2

- Lampen leveres eksl. lyskilde / Bulb not included / Exklusiv Birne
- Lampen leveres med henholdsvis grå og sort stofledning / The lamp comes with, respectively grey or black textile cable / Die Lampe wird mit jeweils grauen und schwarzen Stoff-Kabel geliefert
- Glasplade i bunden / Glassplate bottom / Glas unten



	Skærm Shade Schirm	Baldakin Canopy Baldachin	Transformer Transformer Transformer	Dæmper Dimmer Dimmer	Varenr: Item no. Warennr.	EAN-nr: EAN-no. EAN-nr.
	Sort Black Schwarz	 Krom Chrome Chrom	– – –	– – –	06059140005	 5 705614 107897
	Hvid White Weiß	 Krom Chrome Chrom	– – –	– – –	06059140020	 5 705614 107804

Soul pendel lille, metal

Pendant / Pendel

Højde (cm) / Height (cm) / Höhe (cm)	15
Diameter (cm) / Diameter (cm) / Durchmesser (cm)	20,5
Volt / Voltage / Volt	230V
Antal lyskilder / Number of bulbs / Anzahl Birnen	1
Lyskilde / Light source / Licht	Max 40W E14
Alt. lyskilde / Alt. Light source / Alternativ Licht	7-9W E14 CFL
Ledning / Cable / Kabel	2,5 m
Kollistr: / Number per package / Stück pro VE	4







- Lampen leveres ekskl. lyskilde / Bulb not included / Exklusiv Birne
- Lampen leveres med henholdsvis grå og sort stofledning / The lamp comes with, respectively grey or black textile cable / Die Lampe wird mit jeweils grauen und schwarzen Stoff-Kabel geliefert

Soul vægspot, se side 57

Soul walllamp, see page 57

Soul wandleuchte, siehe Seite 57

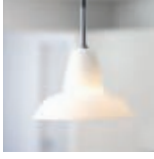

	Skærm Shade Schirm	Baldakin Canopy Baldachin	Transformer Transformer Transformer	Dæmper Dimmer Dimmer	Varenr: Item no. Warennr.	EAN-nr: EAN-no. EAN-nr.
	Sort metal Black metal Schwarz Metall	▽ Sort plast Black plastic Schwarz Kunststoff	- - -	- - -	06018100005	 5 705614 102946
	Hvid metal White metal Weiß Metall	▽ Hvid plast White plastic Weiß Kunststoff	- - -	- - -	06018100020	 5 705614 102953
	Hvid glas White glass Weiß Glas	▽ Hvid plast White plastic Weiß Kunststoff	- - -	- - -	06018800020	 5 705614 102908

Soul pendel stor, metal

Pendant / Pendel

Højde (cm) / Height (cm) / Höhe (cm)	20
Diameter (cm) / Diameter (cm) / Durchmesser (cm)	28,5
Volt / Voltage / Volt	230V
Antal lyskilder / Number of bulbs / Anzahl Birnen	1
Lyskilde / Light source / Licht	Max 60W E27
Alt. lyskilde / Alt. Light source / Alternativ Licht	11-13W E27 CFL
Ledning / Cable / Kabel	2,5 m
Kollistr: / Number per package / Stück pro VE	4







- Lampen leveres ekskl. lyskilde / Bulb not included / Exklusiv Birne
- Lampen leveres med henholdsvis grå og sort stofledning / The lamp comes with, respectively grey or black textile cable / Die Lampe wird mit jeweils grauen und schwarzen Stoff-Kabel geliefert

Soul vægspot, se side 57

Soul walllamp, see page 57

Soul wandleuchte, siehe Seite 57



	Skærm Shade Schirm	Baldakin Canopy Baldachin	Transformer Transformer Transformer	Dæmper Dimmer Dimmer	Varenr: Item no. Warennr.	EAN-nr: EAN-no. EAN-nr.
	Sort metal Black metal Schwarz Metall	▽ Sort plast Black plastic Schwarz Kunststoff	– – –	– – –	06018101005	 5 705614 102922
	Hvid metal White metal Weiß Metall	▽ Hvid plast White plastic Weiß Kunststoff	– – –	– – –	06018101020	 5 705614 102939
	Hvid glas White glass Weiß Glas	▽ Hvid plast White plastic Weiß Kunststoff	– – –	– – –	06018801020	 5 705614 102915

Spirit pendel

Pendant / Pendel

Højde (cm) / Height (cm) / Höhe (cm)	23,8
Diameter (cm) / Diameter (cm) / Durchmesser (cm)	28
Volt / Voltage / Volt	230V
Antal lyskilder / Number of bulbs / Anzahl Birnen	1
Lyskilde / Light source / Licht	Max 60W E27
Alt. lyskilde / Alt. Light source / Alternativ Licht	11-13W E27 CFL
Ledning / Cable / Kabel	2,5 m
Kollistr: / Number per package / Stück pro VE	4



- Lampen leveres ekskl. lyskilde / Bulb not included / Exklusiv Birne
- Lampen leveres med henholdsvis grå og sort PVC ledning / The lamp comes with, respectively grey or black PVC cable / Die Lampe wird mit jeweils grauen und schwarzen Kunststoffkabel geliefert

Spirit bord, gulv og væglampe, se side 58, 86, 107

Spirit table, floor and walllamp, see page 58, 86, 107

Spirit Tisch, Boden und Wandleuchte, siehe Seite 58, 86, 107



	Skærm Shade Schirm	Baldakin Canopy Baldachin	Transformer Transformer Transformer	Dæmper Dimmer Dimmer	Varenr: Item no. Warennr.	EAN-nr: EAN-no. EAN-nr.
	Sort Black Schwarz	▽ Sort plast Black plastic Schwarz Kunststoff	– – –	– – –	06022270105	 5 705614 109600
	Hvid White Weiß	▽ Hvid plast White plastic Weiß Kunststoff	– – –	– – –	06022270120	 5 705614 109594

Vienda pendel

Pendant / Pendel

Diameter (cm) / Diameter (cm) / Durchmesser (cm)	19,5
Antal lyskilder / Number of bulbs / Anzahl Birnen	1
Volt / Voltage / Volt	230V
Lyskilde / Light source / Licht	40W E14
Alt. lyskilde / Alt. Light source / Alternativ Licht	7-9W E14 CFL
Ledning / Cable / Kabel	2 m
Kollistr. / Number per package / Stück pro VE	6

- Lampen leveres ekskl. lyskilde / Bulb not included / Exklusiv Birne
- Ledning i sort PVC / Cable in black PVC / Kabel in schwarzem PVC



Vienda bord- og gulvlampe, se side 88, 113

Vienda table- and floorlamp, see page 88, 113

Vienda Tisch- und Bodenleuchte, siehe Seite 88, 113

	Skærm Shade Schirm	Baldakin Canopy Baldachin	Transformer Transformer Transformer	Dæmper Dimmer Dimmer	Varenr. Item no. Warennr.	EAN-nr. EAN-no. EAN-nr.
	Hvid glas White glass Weiss Glas	▽ Hvid plast White plastic Weiß Kunststoff	- - -	- - -	06071140120	 5 705614 108061
	Sort Black Schwarz	▽ Sort plast Black plastic Schwarz Kunststoff	- - -	- - -	06071140105	 5 705614 108825
	Hvid White Weiss	▽ Hvid plast White plastic Weiß Kunststoff	- - -	- - -	06071140119	 5 705614 108818
	Lime Lime Limette	▽ Sort plast Black plastic Schwarz Kunststoff	- - -	- - -	06071140153	 5 705614 108832
	Lilla Purple Purpur	▽ Sort plast Black plastic Schwarz Kunststoff	- - -	- - -	06071140154	 5 705614 108849

KRONER
CHANDELIERS
KRONLEUCHTER

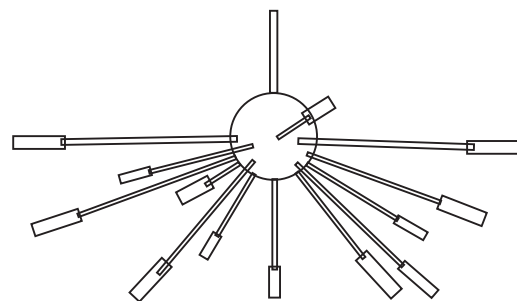

Micro Gil 12 krone

Chandelier / Kronleuchter



Højde (cm) / Height (cm) / Höhe (cm)	45
Diameter (cm) / Diameter (cm) / Durchmesser (cm)	58
Volt / Voltage / Volt	230V~12V
Antal lyskilder / Number of bulbs / Anzahl Birnen	12
Lyskilde / Light source / Licht	10W G4
Ledning / Cable / Kabel	2 m
Kollistr: / Number per package / Stück pro VE	2

Gil væg- og bordlampe, se side 50, 75

Gil wall- and table lamp, see page 50, 75

Gil Wand- und Tischleuchte, siehe Seite 50, 75

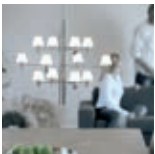

	Skærm Shade Schirm	Finish Finish Finish	Baldakin Canopy Baldachin	Transformer Transformer Transformer	Varenr: Item no. Warennr:	EAN-nr: EAN-no. EAN-nr:
	Hvid glas White glass Weiß Glas	Krom Chrome Chrom	 Krom Chrome Chrom	I 60VA elect.	16658590120	 5 705614 069911

Mir krone

Chandelier / Kronleuchter



Højde (cm) / Height (cm) / Höhe (cm)	30
Diameter (cm) / Diameter (cm) / Durchmesser (cm)	70
Volt / Voltage / Volt	230V~12V
Antal lyskilder / Number of bulbs / Anzahl Birnen	15
Lyskilde / Light source / Licht	10W G4
Ledning / Cable / Kabel	2 m
Kollistr. / Number per package / Stück pro VE	2

Mir plafond, se side 51

Mir plafond, see page 51

Mir plafond, siehe Seite 51





	Skærm Shade Schirm	Finish Finish Finish	Baldakin Canopy Baldachin	Transformer Transformer Transformer	Varenr. Item no. Warennr.	EAN-nr. EAN-no. EAN-nr.
	Krom Chrome Chrom	Krom Chrome Chrom	 Krom Chrome Chrom	I 60VA elect.	06038010101	 5 705614 093596

Mir krone butterfly

Chandelier / Kronleuchter

Højde (cm) / Height (cm) / Höhe (cm)	30
Diameter (cm) / Diameter (cm) / Durchmesser (cm)	70
Volt / Voltage / Volt	230V~12V
Antal lyskilder / Number of bulbs / Anzahl Birnen	15
Lyskilde / Light source / Licht	10W G4
Ledning / Cable / Kabel	2 m
Kollistr. / Number per package / Stück pro VE	2



	Skærm Shade Schirm	Finish Finish Finish	Baldakin Canopy Baldachin	Transformer Transformer Transformer	Varenr. Item no. Warennr.	EAN-nr. EAN-no. EAN-nr.
	Hvid White Weiß	Sort krom Black chrome Schwarz Chrom	 Sort krom Black chrome Schwarz Chrom	I 60VA elect.	06038021620	 5 705614 103332

New String Sac krone

Chandelier / Kronleuchter







Højde (cm) / Height (cm) / Höhe (cm)	70
Volt / Voltage / Volt	230V~12V
Antal lyskilder / Number of bulbs / Anzahl Birnen	7
Lyskilde / Light source / Licht	10W G4
Ledning / Cable / Kabel	2 m
Kollistr.: / Number per package / Stück pro VE	6

Sac væg, se side 56

Sac wall, see page 56

Sac Wand, siehe Seite 56



	Skærm Shade Schirm	Finish Finish Finish	Dæmper Dimmer Dimmer	Transformer Transformer Transformer	Varenr. Item no. Warennr.	EAN-nr. EAN-no. EAN-nr.
	Hvid glas White glass Weiß Glas	Krom Chrome Chrom	på trafo on trafo an Trafo	 Krom Chrome Chrom 80VA elect.	06039607020	 5 705614 090465
	Hvid glas White glass Weiß Glas	Krom Chrome Chrom	touch	 Krom Chrome Chrom 80VA touch	06039607020T	 5 705614 089957

String Sac 14 krone

Chandelier / Kronleuchter

Højde (cm) / Height (cm) / Höhe (cm)	80
Diameter (cm) / Diameter (cm) / Durchmesser (cm)	100
Volt / Voltage / Volt	230V~12V
Antal lyskilder / Number of bulbs / Anzahl Birnen	14
Lyskilde / Light source / Licht	10W G4
Ledning / Cable / Kabel	98 cm
Kollistr.: / Number per package / Stück pro VE	6



- Lampen leveres ekskl. ledning / Cable not included / Exklusiv Kabel
- Med fast rør fra trafo-baldakin til lampe / With a solid tube from transformer/canopy to the lamp / Mit festem Rohr von dem Transformator/Baldachin bis zu der Leuchte

Sac væg, se side 56

Sac wall, see page 56

Sac Wand, siehe Seite 56

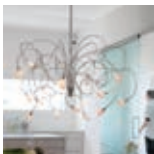

	Skærm Shade Schirm	Finish Finish Finish	Baldakin Canopy Baldachin	Transformer Transformer Transformer	Varen: Item no. Warennr.	EAN-nr: EAN-no. EAN-nr.
	Hvid glas White glass Weiß Glas	Titanium Titanium Titan	 Krom Chrome Chrom	Elektronisk Electronic Elektronisch	06039514120	 5 705614 094739

VÆG/LOFT
WALL/CEILING
WAND/DECKE

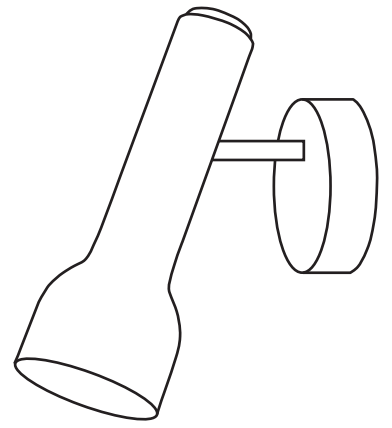



Arc væg

Walllamp / Wandleuchte

Højde (cm) / Height (cm) / Höhe (cm)	56
Bredde (cm) / Width (cm) / Breite (cm)	7,5
Volt / Voltage / Volt	230V
Antal lyskilder / Number of bulbs / Anzahl Birnen	1
Lyskilde / Light source / Licht	40W G9
Kollist: / Number per package / Stück pro VE	8



	Skærm Shade Schirm	Finish Finish Finish	Transformer Transformer Transformer	Dæmper Dimmer Dimmer	Varenr: Item no. Warennr.	EAN-nr: EAN-no. EAN-nr.
	Krom / rustfri stål Chrome / st. steel Chrom / Edelstahl	Krom / rustfri stål Chrome / st. steel Chrom / Edelstahl	– – –	– – –	03034091201	 5 705614 089506

Cole 50 plafond



Plafond / Plafond

Højde (cm) / Height (cm) / Höhe (cm)	15
Diameter (cm) / Diameter (cm) / Durchmesser (cm)	50
Volt / Voltage / Volt	230V
Antal lyskilder / Number of bulbs / Anzahl Birnen	3
Lyskilde / Light source / Licht	40W E14
Alt. lyskilde / Alt. Light source / Alternativ Licht	7-9W E14 CFL
Kollistr: / Number per package / Stück pro VE	2

- Lampen leveres ekskl. lyskilde / Bulb not included / Exklusiv Birne
- Mattered glasplade i bunden / Matt glass plate bottom /
Mattiert Glasplatte unten

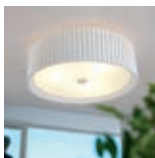

Cole pendel, gulv- og bordlamper, se side 4-5, 66-69, 94-97
Cole pendant, floor- and table lamps, see page 4-5, 66-69, 94-97
Cole Pendeln, Boden- und Tischleuchten, siehe Seite 4-5, 66-69, 94-97

	Skærm i tekstil Shade textile Schirm Textil	Konsol Console Konsole	Transformer Transformer Transformer	Dæmper Dimmer Dimmer	Varenr. Item no. Warennr.	EAN-nr. EAN-no. EAN-nr.
	Hvid plissé White pleat Weiß Plissee	– – –	– – –	– – –	03094500020	 5 705614 094371

Cole 80 x 14 plafond



Plafond / Plafond

Højde (cm) / Height (cm) / Höhe (cm)	15
Længde (cm) / Length (cm) / Länge (cm)	80
Volt / Voltage / Volt	230V
Antal lyskilder / Number of bulbs / Anzahl Birnen	3
Lyskilde / Light source / Licht	40W E14
Alt. lyskilde / Alt. Light source / Alternativ Licht	7-9W E14 CFL
Kollistr: / Number per package / Stück pro VE	2

- Lampen leveres ekskl. lyskilde / Bulb not included / Exklusiv Birne
- Mattered glasplade i bunden / Matt glass plate bottom /
Mattiert Glasplatte unten



Cole pendel, gulv- og bordlamper, se side 4-5, 66-69, 94-97
Cole pendant, floor- and table lamps, see page 4-5, 66-69, 94-97
Cole Pendeln, Boden- und Tischleuchten, siehe Seite 4-5, 66-69, 94-97



	Skærm i tekstil Shade textile Schirm Textil	Konsol Console Konsole	Transformer Transformer Transformer	Dæmper Dimmer Dimmer	Varenr. Item no. Warennr.	EAN-nr. EAN-no. EAN-nr.
	Hvid plissé White pleat Weiß Plissee	– – –	– – –	– – –	03094801420	 5 705614 094388

Cut spot

Spot / Spot

Højde (cm) / Height (cm) / Höhe (cm)	7
Diameter (cm) / Diameter (cm) / Durchmesser (cm)	11,5
Volt / Voltage / Volt	230V
Antal lyskilder / Number of bulbs / Anzahl Birnen	1
Lyskilde / Light source / Licht	40W G9
Kollistr: / Number per package / Stück pro VE	9





	Skærm Shade Schirm	Konsol Console Konsole	Transformer Transformer Transformer	Dæmper Dimmer Dimmer	Varenr. Item no. Warennr.	EAN-nr. EAN-no. EAN-nr.
	Hvid glas White glass Weiß Glas	Titanium Titanium Titanium		På konsol On console An Konsole	03072011120	 5 705614 080626

Cut Duo spot

Spot / Spot

Højde (cm) / Height (cm) / Höhe (cm)	44
Diameter (cm) / Diameter (cm) / Durchmesser (cm)	7
Volt / Voltage / Volt	230V
Antal lyskilder / Number of bulbs / Anzahl Birnen	2
Lyskilde / Light source / Licht	40W G9
Kollistr: / Number per package / Stück pro VE	6





	Skærm Shade Schirm	Konsol Console Konsole	Transformer Transformer Transformer	Dæmper Dimmer Dimmer	Varenr. Item no. Warennr.	EAN-nr. EAN-no. EAN-nr.
	Hvid glas White glass Weiß Glas	Titanium Titanium Titanium			03072031120	 5 705614 082217

Cut Trio spot

Spot / Spot

Højde (cm) / Height (cm) / Höhe (cm)	7
Diameter (cm) / Diameter (cm) / Durchmesser (cm)	24
Volt / Voltage / Volt	230V
Antal lyskilder / Number of bulbs / Anzahl Birnen	3
Lyskilde / Light source / Licht	40W G9
Kollistr: / Number per package / Stück pro VE	6

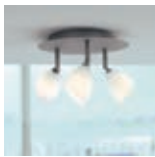

	Skærm Shade Schirm	Konsol Console Konsole	Transformer Transformer Transformer	Dæmper Dimmer Dimmer	Varenr. Item no. Warennr.	EAN-nr. EAN-no. EAN-nr.
	Hvid glas White glass Weiß Glas	Titanium Titanium Titanium			03072051120	 5 705614 082293

Cut gulvlampe og skinner, se side 90, 120
 Cut floorlamp and track, see page 90, 120
 Cut Bodenleuchte und track, siehe Seite 90, 120

Diva vægspot

Wallspot / Wandspot

Højde (cm) / Height (cm) / Höhe (cm)	29,5
Diameter (cm) / Diameter (cm) / Durchmesser (cm)	11
Volt / Voltage / Volt	230V
Antal lyskilder / Number of bulbs / Anzahl Birnen	1
Lyskilde / Light source / Licht	8W E14 CFL
Ledning / Cable / Kabel	2 m
Kollist: / Number per package / Stück pro VE	6

- Hvid PVC ledning med afbryder på Diva hvid og lime / White PCV cable with switch on Diva white and lime / Weiß Kunststoff Kabel mit Schalter auf Diva weiß und Lime
- Sort PVC ledning med afbryder på Diva sort, rød og lilla / Black PCV cable with switch on Diva black, red and purple / Schwarz Kunststoff Kabel mit Schalter auf Diva schwarz, rot und purpur
- Lampen leveres ekskl. lyskilde / Bulb not included / Exklusiv Birne



Diva bord- og gulvlampe, se side 72-73, 98
 Diva table- and floorlamp, see page 72-73, 98
 Diva Tisch- und Bodenleuchte, siehe Seite 72-73, 98

	Skærm Shade Schirm	Konsol Console Konsole	Transformer Transformer Transformer	Dæmper Dimmer Dimmer	Varenr. Item no. Warennr.	EAN-nr. EAN-no. EAN-nr.
	Sort Black Schwarz	Sort Black Schwarz	– – –	– – –	03014140105	 5 705614 104346
	Hvid White Weiß	Hvid White Weiß	– – –	– – –	03014140120	 5 705614 104353
	Lime Lime Limette	Lime Lime Limette	– – –	– – –	03014140153	 5 705614 105114
	Rød Red Rot	Rød Red Rot	– – –	– – –	03014140134	 5 705614 105220
	Lilla Purple Purpur	Lilla Purple Purpur	– – –	– – –	03014140154	 5 705614 105282

Diva vægflex

Wallflex / Wandflex

Højde (cm) / Height (cm) / Höhe (cm)	45
Diameter (cm) / Diameter (cm) / Durchmesser (cm)	11
Volt / Voltage / Volt	230V
Antal lyskilder / Number of bulbs / Anzahl Birnen	1
Lyskilde / Light source / Licht	8W E14 CFL
Ledning / Cable / Kabel	2 m
Kollist: / Number per package / Stück pro VE	6

- Hvid PVC ledning med afbryder på Diva hvid og lime / White PCV cable with switch on Diva white and lime / Weiß Kunststoff Kabel mit Schalter auf Diva weiß und Lime
- Sort PVC ledning med afbryder på Diva sort, rød og lilla / Black PCV cable with switch on Diva black, red and purple / Schwarz Kunststoffkabel mit Schalter auf Diva schwarz, rot und purpur
- Lampen leveres ekskl. lyskilde / Bulb not included / Exklusiv Birne



Diva bord- og gulvlampe, se side 72-73, 98
 Diva table- and floorlamp, see page 72-73, 98
 Diva Tisch- und Bodenleuchte, siehe Seite 72-73, 98



	Skærm Shade Schirm	Konsol Console Konsole	Transformer Transformer Transformer	Dæmper Dimmer Dimmer	Varenr. Item no. Warennr.	EAN-nr. EAN-no. EAN-nr.
	Sort Black Schwarz	Sort Black Schwarz	– – –	– – –	03014140205	 5 705614 104360
	Hvid White Weiß	Hvid White Weiß	– – –	– – –	03014140220	 5 705614 104377
	Lime Lime Limette	Lime Lime Limette	– – –	– – –	03014140253	 5 705614 105121
	Rød Red Rot	Rød Red Rot	– – –	– – –	03014140234	 5 705614 105237
	Lilla Purple Purpur	Lilla Purple Purpur	– – –	– – –	03014140254	 5 705614 105299

Dive vægspot

Spot / Spot

Højde (cm) / Height (cm) / Höhe (cm)	28
Diameter (cm) / Diameter (cm) / Durchmesser (cm)	13
Volt / Voltage / Volt	230V
Antal lyskilder / Number of bulbs / Anzahl Birnen	1
Lyskilde / Light source / Licht	40W E14
Alt. lyskilde / Alt. Light source / Alternativ Licht	7-9W E14 CFL
Kollistr. / Number per package / Stück pro VE	6

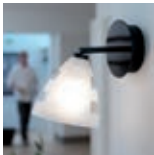



	Skærm i glas Shade glass Schirm Glas	Konsol Console Konsole	Transformer Transformer Transformer	Dæmper Dimmer Dimmer	Varenr. Item no. Warennr.	EAN-nr. EAN-no. EAN-nr.
	Klar & frosted Clear & frosted Klar & frosted	Sort Black Schwarz	- - -	- - -	03093010539	 5 705614 099130

Dive Duo spot

Duo spot / Duo spot

Højde (cm) / Height (cm) / Höhe (cm)	23
Diameter (cm) / Diameter (cm) / Durchmesser (cm)	43
Volt / Voltage / Volt	230V
Antal lyskilder / Number of bulbs / Anzahl Birnen	2
Lyskilde / Light source / Licht	40W E14
Alt. lyskilde / Alt. Light source / Alternativ Licht	7-9W E14 CFL
Kollistr. / Number per package / Stück pro VE	4





	Skærm i glas Shade glass Schirm Glas	Konsol Console Konsole	Transformer Transformer Transformer	Dæmper Dimmer Dimmer	Varenr. Item no. Warennr.	EAN-nr. EAN-no. EAN-nr.
	Klar & frosted Clear & frosted Klar & frosted	Sort Black Schwarz	- - -	- - -	03093020539	 5 705614 099147

Dive Trio spot

Trio spot / Trio spot

Højde (cm) / Height (cm) / Höhe (cm)	21
Diameter (cm) / Diameter (cm) / Durchmesser (cm)	45
Volt / Voltage / Volt	230V
Antal lyskilder / Number of bulbs / Anzahl Birnen	3
Lyskilde / Light source / Licht	40W E14
Alt. lyskilde / Alt. Light source / Alternativ Licht	7-9W E14 CFL
Kollistr. / Number per package / Stück pro VE	2



	Skærm i glas Shade glass Schirm Glas	Konsol Console Konsole	Transformer Transformer Transformer	Dæmper Dimmer Dimmer	Varenr. Item no. Warennr.	EAN-nr. EAN-no. EAN-nr.
	Klar & frosted Clear & frosted Klar & frosted	Sort Black Schwarz	- - -	- - -	03093030539	 5 705614 099154

Dive pendel, se side 7

Dive pendant, see page 7



Dive Pendeln, siehe Seite 7

Evoke væg

Wall / Wand

Højde (cm) / Height (cm) / Höhe (cm)	12
Bredde (cm) / Width (cm) / Breite (cm)	10
Volt / Voltage / Volt	230V
Antal lyskilder / Number of bulbs / Anzahl Birnen	1
Lyskilde / Light source / Licht	40W G9
Kollistr: / Number per package / Stück pro VE	8

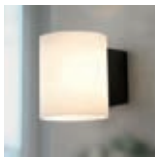

	Skærm Shade Schirm	Konsol Console Konsole	Transformer Transformer Transformer	Dæmper Dimmer Dimmer	Varenr. Item no. Warennr.	EAN-nr. EAN-no. EAN-nr.
	Hvid glas White glass Weiß Glas	Sort Black Schwarz	- - -	- - -	03036001220	 5 705614 096221



Evoke væg

Wall / Wand

Højde (cm) / Height (cm) / Höhe (cm)	18
Bredde (cm) / Width (cm) / Breite (cm)	15,5
Volt / Voltage / Volt	230V
Antal lyskilder / Number of bulbs / Anzahl Birnen	1
Lyskilde / Light source / Licht	40W E14
Alt. lyskilde / Alt. Light source / Alternativ Licht	7-9W E14 CFL
Ledning / Cable / Kabel	2 m
Kollistr: / Number per package / Stück pro VE	8



- Lampen leveres ekskl. lyskilde / Bulb not included / Exklusiv Birne
- Hvid PVC ledning med afbryder / White PVC cable with switch / Weiße Kunststoffkabel mit Schalter

	Skærm Shade Schirm	Konsol Console Konsole	Transformer Transformer Transformer	Dæmper Dimmer Dimmer	Varenr. Item no. Warennr.	EAN-nr. EAN-no. EAN-nr.
	Hvid metal White metal Weiß Metall	Hvid metal White metal Weiß Metall	- - -	- - -	03036141220	 5 705614 111184



Gil vægspot

Spot / Spot

Højde (cm) / Height (cm) / Höhe (cm)	10
Bredde (cm) / Width (cm) / Breite (cm)	10
Diameter (cm) / Diameter (cm) / Durchmesser (cm)	9
Dybde (cm) / Depth (cm) / Tiefe (cm)	16
Volt / Voltage / Volt	230V~12V
Antal lyskilder / Number of bulbs / Anzahl Birnen	1
Lyskilde / Light source / Licht	35W G4
Kollistr. / Number per package / Stück pro VE	6



Gil krone og bord, se side 28, 75
 Gil chandelier and table, see page 28, 75
 Gil Kronenleuchter und Tisch, siehe Seite 28, 75

	Skærm Shade Schirm	Konsol Console Konsole	Transformer Transformer Transformer	Dæmper Dimmer Dimmer	Varenr. Item no. Warennr.	EAN-nr. EAN-no. EAN-nr.
	Hvid glas White glass Weiß Glas	Rustfri stål Stainless steel Edelstahl	60VA indbygget 60VA build in 60VA einbau	På konsol on console An Konsole	16618570020	 5 705614 046233



Gil vægspot

Spot / Spot

Højde (cm) / Height (cm) / Höhe (cm)	10
Bredde (cm) / Width (cm) / Breite (cm)	10
Diameter (cm) / Diameter (cm) / Durchmesser (cm)	9
Dybde (cm) / Depth (cm) / Tiefe (cm)	16
Volt / Voltage / Volt	230V~12V
Antal lyskilder / Number of bulbs / Anzahl Birnen	1
Lyskilde / Light source / Licht	35W G4
Kollistr. / Number per package / Stück pro VE	6

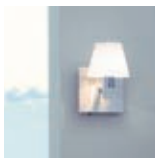

Gil krone og bord, se side 28, 75
 Gil chandelier and table, see page 28, 75
 Gil Kronenleuchter und Tisch, siehe Seite 28, 75



	Skærm Shade Schirm	Konsol Console Konsole	Transformer Transformer Transformer	Dæmper Dimmer Dimmer	Varenr. Item no. Warennr.	EAN-nr. EAN-no. EAN-nr.
	Hvid glas White glass Weiß Glas	Rustfri stål Stainless steel Edelstahl	60VA indbygget 60VA build in 60VA einbau	På konsol on console An Konsole	16619570020	 5 705614 043386

Horizon spot

Spot / Spot

Højde (cm) / Height (cm) / Höhe (cm)	9,5
Dybde (cm) / Width (cm) / Tiefe (cm)	20
Volt / Voltage / Volt	230V~12V
Antal lyskilder / Number of bulbs / Anzahl Birnen	1
Lyskilde / Light source / Licht	35W Gy6,35
Kollistr: / Number per package / Stück pro VE	6





	Skærm Shade Schirm	Konsol Console Konsole	Transformer Transformer Transformer	Dæmper Dimmer Dimmer	Varenr. Item no. Warennr.	EAN-nr. EAN-no. EAN-nr.
	Hvid / klar White / Clear Weiß / Klar	Krom Chrome Chrom	indbygget build in einbau	– – –	03080001124	 5 705614 106258

Horizon væglampe

Wall / Wand

Højde (cm) / Height (cm) / Höhe (cm)	9
Dybde (cm) / Width (cm) / Tiefe (cm)	18
Volt / Voltage / Volt	230V~12V
Antal lyskilder / Number of bulbs / Anzahl Birnen	1
Lyskilde / Light source / Licht	35W G4
Kollistr: / Number per package / Stück pro VE	6

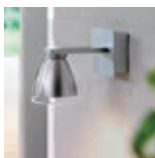



	Skærm Shade Schirm	Konsol Console Konsole	Transformer Transformer Transformer	Dæmper Dimmer Dimmer	Varenr. Item no. Warennr.	EAN-nr. EAN-no. EAN-nr.
	Klar / metal Clear / metal Klar / Metall	Metal Metal Metall	indbygget build in einbau	– – –	03080001124	 5 705614 106241

Horizon duo væg

Wall / Wand

Højde (cm) / Height (cm) / Höhe (cm)	17,5
Bredde (cm) / Width (cm) / Breite (cm)	24
Volt / Voltage / Volt	230V~12V
Antal lyskilder / Number of bulbs / Anzahl Birnen	2
Lyskilde / Light source / Licht	20W G4
Kollistr: / Number per package / Stück pro VE	6



	Skærm Shade Schirm	Konsol Console Konsole	Transformer Transformer Transformer	Dæmper Dimmer Dimmer	Varenr: Item no. Warennr.	EAN-nr: EAN-no. EAN-nr.
	Klar / metal Clear / metal Klar / Metall	Metal Metal Metall	Indbygget Build in Einbau	– – –	03080021124	 5 705614 106234

Kelby vægspot

Spot / Spot





Højde (cm) / Height (cm) / Höhe (cm)	11,5
Diameter (cm) / Diameter (cm) / Durchmesser (cm)	10
Volt / Voltage / Volt	230V~12V
Antal lyskilder / Number of bulbs / Anzahl Birnen	1
Lyskilde / Light source / Licht	35W Gy6,35
Kollistr: / Number per package / Stück pro VE	6

Kelby badlamper, gulvlamper, pendler og skinner, se side
12-14, 102-103, 110-111, 118, 126-128

Kelby bathroom lamps, floorlamps, pendant and tracks, see page
12-14, 102-103, 110-111, 118, 126-128

Kelby Badezimmerleuchte, Bodenleuchte, Pendeln und Tracks, siehe Seite
12-14, 102-103, 110-111, 118, 126-128



	Skærm Shade Schirm	Konsol Console Konsole	Transformer Transformer Transformer	Dæmper Dimmer Dimmer	Varenr: Item no. Warennr.	EAN-nr: EAN-no. EAN-nr.
	Hvid glas White glass Weiß Glas	Krom Chrome Chrom	Indbygget Build in Einbau	På konsol on console An Konsole	03017121120	 5 705614 101321
	Sort glas Black glass Schwarz Glas	Krom Chrome Chrom	Indbygget Build in Einbau	På konsol on console An Konsole	03017121105	 5 705614 101338

Kelby Trio spot

Trio spot / Trio spot



Højde (cm) / Height (cm) / Höhe (cm)	21
Diameter (cm) / Diameter (cm) / Durchmesser (cm)	31
Volt / Voltage / Volt	230V~12V
Antal lyskilder / Number of bulbs / Anzahl Birnen	3
Lyskilde / Light source / Licht	35W Gy6,35
Kollistr: / Number per package / Stück pro VE	4

Kelby badlamper, gulvlamper, pendler og skinner, se side 12-14, 102-103, 110-111, 118, 126-128

Kelby bathroom lamps, floorlamps, pendant and tracks, see page 12-14, 102-103, 110-111, 118, 126-128

Kelby Badezimmerleuchte, Bodenleuchte, Pendeln und Tracks, siehe Seite 12-14, 102-103, 110-111, 118, 126-128



	Skærm Shade Schirm	Konsol Console Konsole	Transformer Transformer Transformer	Dæmper Dimmer Dimmer	Varenr: Item no. Warennr.	EAN-nr: EAN-no. EAN-nr.
	Hvid glas White glass Weiß Glas	Krom Chrome Chrom	Indbygget Build in Einbau	– – –	03017321120	 5 705614 102779
	Sort glas Black glass Schwarz Glas	Krom Chrome Chrom	Indbygget Build in Einbau	– – –	03017321105	 5 705614 102762

Metro vægspot

Spot / Spot

Højde (cm) / Height (cm) / Höhe (cm)	11,5
Diameter (cm) / Diameter (cm) / Durchmesser (cm)	9
Volt / Voltage / Volt	230V
Antal lyskilder / Number of bulbs / Anzahl Birnen	1
Lyskilde / Light source / Licht	8W E14 CFL
Kollistr: / Number per package / Stück pro VE	6

- Lampen leveres ekskl. lyskilde / Bulb not included / Exklusiv Birne

Metro skinner, se side 119

Metro tracks, see page 119

Metro Tracks, siehe Seite 119



	Skærm Shade Schirm	Konsol Console Konsole	Transformer Transformer Transformer	Dæmper Dimmer Dimmer	Varenr: Item no. Warennr.	EAN-nr: EAN-no. EAN-nr.
	Sort Black Schwarz	Sort Black Schwarz	– – –	– – –	03020140105	 5 705614 107187
	Hvid White Weiß	Hvid White Weiß	– – –	– – –	03020140120	 5 705614 107194
	Sølv Silver Silber	Sølv Silver Silber	– – –	– – –	03020140106	 5 705614 107200

Metro trio spot

Trio spot / Trio Spot

Diameter (cm) / Diameter (cm) / Durchmesser (cm)	22
Volt / Voltage / Volt	230V
Antal lyskilder / Number of bulbs / Anzahl Birnen	3
Lyskilde / Light source / Licht	8W E14 CFL
Kollistr: / Number per package / Stück pro VE	6

- Lampen leveres ekskl. lyskilde / Bulb not included / Exklusiv Birne

Metro skinner, se side 119

Metro tracks, see page 119

Metro Tracks, siehe Seite 119



	Skærm Shade Schirm	Konsol Console Konsole	Transformer Transformer Transformer	Dæmper Dimmer Dimmer	Varenr: Item no. Warennr.	EAN-nr: EAN-no. EAN-nr.
	Sort Black Schwarz	Sort Black Schwarz	– – –	– – –	03020160105	 5 705614 107224
	Hvid White Weiß	Hvid White Weiß	– – –	– – –	03020160120	 5 705614 107231
	Sølv Silver Silber	Sølv Silver Silber	– – –	– – –	03020160106	 5 705614 107217

Micro Gil duo væg

Wall / Wand



Højde (cm) / Height (cm) / Höhe (cm)	10
Bredde (cm) / Width (cm) / Breite (cm)	10
Diameter (cm) / Diameter (cm) / Durchmesser (cm)	6,5
Volt / Voltage / Volt	230V~12V
Antal lyskilder / Number of bulbs / Anzahl Birnen	2
Lyskilde / Light source / Licht	20W G4
Kollistr. / Number per package / Stück pro VE	6

Gil bord og krone, se side 28, 75

Gil table and chandelier, see page 28, 75

Gil Tisch und Kronenleuchter, siehe Seite 28, 75



	Skærm Shade Schirm	Konsol Console Konsole	Transformer Transformer Transformer	Dæmper Dimmer Dimmer	Varenr: Item no. Warennr.	EAN-nr: EAN-no. EAN-nr.
	Hvid glas White glass Weiß Glas	Rustfri stål Stainless steel Edelstahl	60VA indbygget 60VA build in 60VA einbau	På konsol on console An Konsole	16619592020	 5 705614 048923

Mir loftlampe

Ceiling lamp / Deckenleuchte



Højde (cm) / Height (cm) / Höhe (cm)	28
Diameter (cm) / Diameter (cm) / Durchmesser (cm)	71
Volt / Voltage / Volt	230V~12V
Antal lyskilder / Number of bulbs / Anzahl Birnen	15
Lyskilde / Light source / Licht	10W G4
Kollistr: / Number per package / Stück pro VE	2



Mir krone, se side 29

Mir chandelier, see page 29

Mir Kronenleuchter, siehe Seite 29

	Skærm Shade Schirm	Konsol Console Konsole	Transformer Transformer Transformer	Dæmper Dimmer Dimmer	Varenr. Item no. Warennr.	EAN-nr. EAN-no. EAN-nr.
	Krom Chrome Chrom	Krom Chrome Chrom	I 60VA indbygget I 60VA build in I 60VA einbau	– – –	03099380101	 5 705614 099970

Neptun vægflex

Wall flex / Wand flex

Længde (cm) / Length (cm) / Lenge (cm)	45
Antal lyskilder / Number of bulbs / Anzahl Birnen	1
Lyskilde / Light source / Licht	2,5W LED
Kollistr. / Number per package / Stück pro VE	4

- Grå textilledning med plug in LED driver på Neptun hvid / Grey textile-cable with plug in LED driver on Neptun white / Grau Textilkabel mit LED Stecker auf Neptun weiß
- Sort textilledning med plug in LED driver på Neptun sort, lime, rød og lilla / Black textile cable with plug in LED driver on Neptun black, lime, red and purple / Schwarzes Textilkabel in mit LED Stecker auf Neptun schwarz, lime, rot und purpur
- Med afbryder på konsol / With switch on the console / Mit Schalter auf das Konsole



Neptun bord- og gulvlampe, se side 84, 106
 Neptun table- and floor lamp, see page 84, 106
 Neptun Tisch- und Bodenleuchte, siehe Seite 84, 106

	Skærm Shade Schirm	Konsol Console Konsole	Transformer Transformer Transformer	Dæmper Dimmer Dimmer	Varenr. Item no. Warennr.	EAN-nr. EAN-no. EAN-nr.
	Sort Black Schwarz	Sort Black Schwarz	LED driver	— — —	03012010505	 5 705614 104285
	Hvid White Weiß	Hvid White Weiß	LED driver	— — —	03012012020	 5 705614 104315
	Lime Lime Limette	Lime Lime Limette	LED driver	— — —	03012015353	 5 705614 106487
	Rød Red Rot	Rød Red Rot	LED driver	— — —	03012013434	 5 705614 106494
	Lilla Purple Purpur	Lilla Purple Purpur	LED driver	— — —	03012015454	 5 705614 106500

Razz Mini Harlekin

Wall / Wand



Højde (cm) / Height (cm) / Höhe (cm)	24
Bredde (cm) / Width (cm) / Breite (cm)	19
Diameter (cm) / Diameter (cm) / Durchmesser (cm)	7
Dybde (cm) / Width (cm) / Tiefe (cm)	13
Volt / Voltage / Volt	230V~12V
Antal lyskilder / Number of bulbs / Anzahl Birnen	2
Lyskilde / Light source / Licht	20W G4
Kollistr: / Number per package / Stück pro VE	6

Archi Harlekin gulvlampe, se side 91

Archi Harlekin floor lamp, see page 91

Archi Harlekin Bodenleuchte, siehe Seite 91

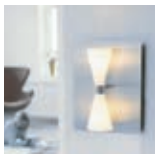



	Skærm Shade Schirm	Konsol Console Konsole	Transformer Transformer Transformer	Dæmper Dimmer Dimmer	Varen: Item no. Warennr.	EAN-nr: EAN-no. EAN-nr.
	Hvid glas White glass Weiß Glas	Rustfri stål Stainless steel Edelstahl	60VA indbygget 60VA build in 60VA einbau	På konsol on console An Konsole	03047540020	 5 705614 048114

Saw

Wall / Wand

Højde (cm) / Height (cm) / Höhe (cm)	25
Bredde (cm) / Width (cm) / Breite (cm)	25
Dybde (cm) / Depth (cm) / Tiefe (cm)	2,5
Volt / Voltage / Volt	230V~12V
Antal lyskilder / Number of bulbs / Anzahl Birnen	4
Lyskilde / Light source / Licht	10W G4
Kollistr. / Number per package / Stück pro VE	6





	Skærm Shade Schirm	Finish Finish Finish	Transformer Transformer Transformer	Dæmper Dimmer Dimmer	Varenr: Item no. Warennr.	EAN-nr: EAN-no. EAN-nr.
	Frosted glas Frosted glass Frostet Glas	Rustfri stål Stainless steel Edelstahl	60VA indbygget 60VA build in 60VA einbau	På konsol on console An Konsole	16603001200	 5 705614 041283

Strax

Wall / Wand

Højde (cm) / Height (cm) / Höhe (cm)	100
Bredde (cm) / Width (cm) / Breite (cm)	13
Dybde (cm) / Depth (cm) / Tiefe (cm)	2,5
Volt / Voltage / Volt	230V~12V
Antal lyskilder / Number of bulbs / Anzahl Birnen	5
Lyskilde / Light source / Licht	10W G4
Kollistr. / Number per package / Stück pro VE	6



	Skærm Shade Schirm	Finish Finish Finish	Transformer Transformer Transformer	Dæmper Dimmer Dimmer	Varenr: Item no. Warennr.	EAN-nr: EAN-no. EAN-nr.
	Frosted glas Frosted glass Frostet Glas	Rustfri stål Stainless steel Edelstahl	60VA indbygget 60VA build in 60VA einbau	På konsol on console An Konsole	16601001200	 5 705614 041269

Sac 3-spot

Wall 10 x 10 / Wand 10 x 10



Højde (cm) / Height (cm) / Höhe (cm)	10
Bredde (cm) / Width (cm) / Breite (cm)	10
Diameter (cm) / Diameter (cm) / Durchmesser (cm)	4
Dybde (cm) / Width (cm) / Tiefe (cm)	14
Volt / Voltage / Volt	230V~12V
Antal lyskilder / Number of bulbs / Anzahl Birnen	3
Lyskilde / Light source / Licht	10W G4
Kollistr: / Number per package / Stück pro VE	6

Sac krone, se side 30-31

Sac chandelier, see page 30-31

Sac Kronenleuchter, siehe Seite 30-31

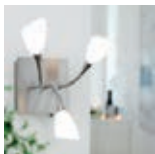

	Skærm Shade Schirm	Konsol Console Konsole	Transformer Transformer Transformer	Dæmper Dimmer Dimmer	Varenr: Item no. Warennr.	EAN-nr: EAN-no. EAN-nr.
	Hvid glas White glass Weiß Glas	Rustfri stål Stainless steel Edelstahl	60VA Indbygget 60VA Build in 60VA Einbau	På konsol on console An Konsole	16617390020	 5 705614 043027

Soul flexspot

Flexspot / Flexspot

Længde (cm) / Length (cm) / Lenge (cm)	28,5
Diameter (cm) / Diameter (cm) / Durchmesser (cm)	10,8
Volt / Voltage / Volt	230V~12V
Antal lyskilder / Number of bulbs / Anzahl Birnen	1
Lyskilde / Light source / Licht	20W G4
Kollistr: / Number per package / Stück pro VE	6





- Med afbryder på konsol / With switch on the console / Mit Schalter auf das Konsole
- Grå textilledning på Soul hvid / Grey textile cable on Soul white / Grau Textilkabel auf Soul weiß
- Sort textilledning på Soul sort / Black textile cable on Soul black / Schwarzes Textilkabel auf Soul schwarz

Soul pendler, se side 22-23

Soul pendants, see page 22-23

Soul pendeln, siehe Seite 22-23



	Skærm Shade Schirm	Konsol Console Konsole	Transformer Transformer Transformer	Dæmper Dimmer Dimmer	Varenr: Item no. Warennr.	EAN-nr: EAN-no. EAN-nr.
	Hvid glas White glass Weiß Glas	Hvid White Weiß	20VA stik 20VA plug-in 20VA Stecker	– – –	03018802020	 5 705614 102892
	Sort glas Black glass Schwarz Glas	Sort Black Schwarz	20VA stik 20VA plug-in 20VA Stecker	– – –	03018800505	 5 705614 102885

Spirit væglampe

Wall / Wand

Højde (cm) / Height (cm) / Höhe (cm)	26
Dybde (cm) / Width (cm) / Tiefe (cm)	32,3
Volt / Voltage / Volt	230V~12V
Antal lyskilder / Number of bulbs / Anzahl Birnen	1
Lyskilde / Light source / Licht	35W Gy6,35
Kollistr: / Number per package / Stück pro VE	8





- Med afbryder på konsol / With switch on the console / Mit Schalter auf das Konsole
- Hvid PVCledning på Spirit hvid / White PVC cable on Spirit white / Weiß Kunststoffkabel auf Spirit weiß
- Sort PVCledning på Spirit sort / Black PVC cable on Spirit black / Schwarzes Kunststoffkabel auf Spirit schwarz

Spirit pendel, bord- og gulvlampe, se side 24, 86, 107

Spirit pendant, table- and floorlamp, see page 24, 86, 107

Spirit pendel, Tisch- und Bodenleuchte, siehe Seite 24, 86, 107



	Skærm Shade Schirm	Konsol Console Konsole	Transformer Transformer Transformer	Dæmper Dimmer Dimmer	Varenr: Item no. Warennr.	EAN-nr: EAN-no. EAN-nr.
	Sort metal Black metal Schwarz Metall	Krom Chrome Chrom	35VA Indbygget 35VA Build in 35VA Einbau	På konsol on console An Konsole	03022010105	 5 705614 109532
	Hvid metal White metal Weiß Metall	Krom Chrome Chrom	35VA Indbygget 35VA Build in 35VA Einbau	På konsol on console An Konsole	03022010120	 5 705614 109549

Straight vægspot

Wall spot / Wandspot

Højde (cm) / Height (cm) / Höhe (cm)	11
Diameter (cm) / Diameter (cm) / Durchmesser (cm)	9
Volt / Voltage / Volt	230V
Antal lyskilder / Number of bulbs / Anzahl Birnen	1
Lyskilde / Light source / Licht	15W R63 E27
Ledning / Cable / Kabel	2 m
Kollistr: / Number per package / Stück pro VE	6

- Med afbryder på skærm / With switch on the shade / Mit Schalter auf das Schirm
- Lampen leveres ekskl. lyskilde / Bulb not included / Exklusiv Birne
- Hvid PVC ledning / White PVC cable / Weiße Kunststoffkabel



Straight bord- og gulvlampe, se side 87-108
 Straight table- and floor lamp, see page 87-108
 Straight Tisch- und Bodenleuchte, siehe Seite 87-108

	Skærm Shade Schirm	Konsol Console Konsole	Transformer Transformer Transformer	Dæmper Dimmer Dimmer	Varenr. Item no. Warennr.	EAN-nr. EAN-no. EAN-nr.
	Sort Black Schwarz	Sort Black Schwarz	- - -	- - -	03019270105	 5 705614 106999
	Hvid White Weiß	Hvid White Weiß	- - -	- - -	03019270120	 5 705614 107002
	Lime Lime Limette	Lime Lime Limette	- - -	- - -	03019270153	 5 705614 107019
	Sølv Silver Silber	Sølv Silver Silber	- - -	- - -	03019270106	 5 705614 107866



Swing væg

Wall / Wand

Højde (cm) / Height (cm) / Höhe (cm)	24,5
Bredde (cm) / Width (cm) / Breite (cm)	9
Længde (cm) / Length (cm) / Lenge (cm)	9
Volt / Voltage / Volt	230V
Antal lyskilder / Number of bulbs / Anzahl Birnen	1
Lyskilde / Light source / Licht	40W G9
Ledning / Cable / Kabel	2 m
Kollistr: / Number per package / Stück pro VE	6

- Sort PVC ledning med afbryder / Black PVC cable with switch / Schwarzes Kunststoffkabel mit Schalter

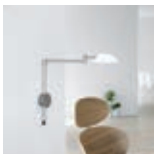



	Skærm Shade Schirm	Konsol Console Konsole	Transformer Transformer Transformer	Dæmper Dimmer Dimmer	Varenr: Item no. Warennr.	EAN-nr: EAN-no. EAN-nr.
	Hvid glas White glass Weiß Glas	Titanium Titanium Titanium	– – –	– – –	03073230720	 5 705614 077886

Tozz Loops væg

Wall / Wand

Højde (cm) / Height (cm) / Höhe (cm)	11
Bredde (cm) / Width (cm) / Breite (cm)	11
Diameter (cm) / Diameter (cm) / Durchmesser (cm)	14
Dybde (cm) / Depth (cm) / Tiefe (cm)	19
Volt / Voltage / Volt	230V~12V
Antal lyskilder / Number of bulbs / Anzahl Birnen	1
Lyskilde / Light source / Licht	20W G4
Kollistr. / Number per package / Stück pro VE	6



	Skærm Shade Schirm	Konsol Console Konsole	Transformer Transformer Transformer	Dæmper Dimmer Dimmer	Varenr: Item no. Warennr.	EAN-nr: EAN-no. EAN-nr.
	Hvid glas White glass Weiß Glas	Rustfri stål Stainless steel Edelstahl	35VA indbygget 35VA build in 35VA einbau	På konsol on console An Konsole	03048460020X	 5 705614 048121

Wic spot

Spot / Spot



Diameter (cm) / Diameter (cm) / Durchmesser (cm)	11,5
Diameter (cm) / Diameter (cm) / Durchmesser (cm)	8
Volt / Voltage / Volt	230V
Antal lyskilder / Number of bulbs / Anzahl Birnen	1
Lyskilde / Light source / Licht	40W G9
Kollistr: / Number per package / Stück pro VE	9

Wic skinne, se side 122

Wic track, see page 122

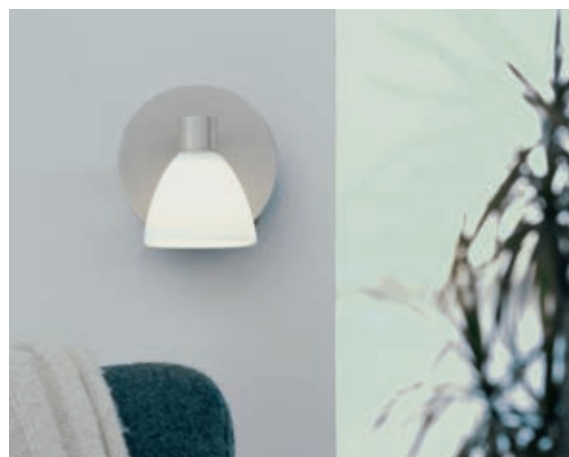
Wic Track, siehe Seite 122



	Skærm Shade Schirm	Konsol Console Konsole	Transformer Transformer Transformer	Dæmper Dimmer Dimmer	Varenr. Item no. Warennr.	EAN-nr. EAN-no. EAN-nr.
	Hvid glas White glass Weiß Glas	Titanium Titanium Titanium	– – –	På konsol On console An Konsole	03078011120	 5 705614 081975

Wic Duo spot

Spot / Spot



Længde (cm) / Length (cm) / Lenge (cm)	44
Diameter (cm) / Diameter (cm) / Durchmesser (cm)	8
Volt / Voltage / Volt	230V
Antal lyskilder / Number of bulbs / Anzahl Birnen	2
Lyskilde / Light source / Licht	40W G9
Kollistr: / Number per package / Stück pro VE	6

Wic skinne, se side 122

Wic track, see page 122

Wic Track, siehe Seite 122



	Skærm Shade Schirm	Konsol Console Konsole	Transformer Transformer Transformer	Dæmper Dimmer Dimmer	Varenr. Item no. Warennr.	EAN-nr. EAN-no. EAN-nr.
	Hvid glas White glass Weiß Glas	Titanium Titanium Titanium	– – –	– – –	03078031120	 5 705614 082255

Wic Trio spot

Spot / Spot



Diameter (cm) / Diameter (cm) / Durchmesser (cm)	24
Diameter (cm) / Diameter (cm) / Durchmesser (cm)	8
Volt / Voltage / Volt	230V
Antal lyskilder / Number of bulbs / Anzahl Birnen	3
Lyskilde / Light source / Licht	40W G9
Kollistr: / Number per package / Stück pro VE	6

Wic skinne, se side 122

Wic track, see page 122

Wic Track, siehe Seite 122

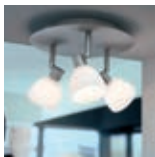

	Skærm Shade Schirm	Konsol Console Konsole	Transformer Transformer Transformer	Dæmper Dimmer Dimmer	Varenr. Item no. Warennr.	EAN-nr. EAN-no. EAN-nr.
	Hvid glas White glass Weiß Glas	Titanium Titanium Titanium	- - -	- - -	03078051120	 5 705614 082330

Wic Flexspot

Flex spot / Flexspot



Diameter (cm) / Diameter (cm) / Durchmesser (cm)	11
Diameter (cm) / Diameter (cm) / Durchmesser (cm)	8
Volt / Voltage / Volt	230V
Antal lyskilder / Number of bulbs / Anzahl Birnen	1
Lyskilde / Light source / Licht	40W G9
Kollistr: / Number per package / Stück pro VE	6

Wic skinne, se side 122

Wic track, see page 122

Wic Track, siehe Seite 122



	Skærm Shade Schirm	Konsol Console Konsole	Transformer Transformer Transformer	Dæmper Dimmer Dimmer	Varenr. Item no. Warennr.	EAN-nr. EAN-no. EAN-nr.
	Hvid glas White glass Weiß Glas	Krom Chrome Chrom	- - -	På konsol On console An Konsole	03078110120	 5 705614 095231

Vip Dove væg

Wall / Wand



Højde (cm) / Height (cm) / Höhe (cm)	29
Diameter (cm) / Diameter (cm) / Durchmesser (cm)	10
Volt / Voltage / Volt	230V
Antal lyskilder / Number of bulbs / Anzahl Birnen	1
Lyskilde / Light source / Licht	40W G9
Kollistr: / Number per package / Stück pro VE	6

Swing Dove gulvlampe, se side 112

Swing Dove floorlamp, see page 112

Swing Dove Bodenleuchte, siehe Seite 112

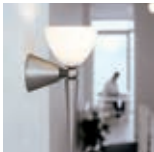

	Skærm Shade Schirm	Konsol Console Konsole	Transformer Transformer Transformer	Dæmper Dimmer Dimmer	Varenr: Item no. Warennr.	EAN-nr: EAN-no. EAN-nr.
	Hvid glas White glass Weiß Glas	Titanium Titanium Titanium	– – –	– – –	03051091720	 5 705614 082835

BORDLAMPER
TABLE LAMPS
TISCHLEUCHTEN

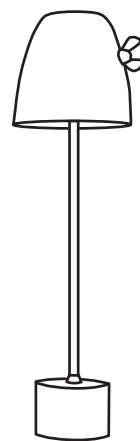



Cole 2 bord I3 lampefod

Table I3 base / Tisch I3 Fuß

Højde m. skærm (cm) / Height w. shade(cm) / Höhe m. Schirm (cm)	56
Diameter (cm) / Diameter (cm) / Durchmesser (cm)	13
Volt / Voltage / Volt	230V
Antal lyskilder / Number of bulbs / Anzahl Birnen	1
Lyskilde / Light source / Licht	60W E27
Alt. lyskilde / Alt. Light source / Alternativ Licht	11-13W E27 CFL
Ledning / Cable / Kabel	2 m
Kollistr. / Number per package / Stück pro VE	4

- Ledning i grå tekstil / Cable in grey textile / Kabel in grauen Textil
- Lampen leveres ekskl. lyskilde / Bulb not included / Exklusiv Birne
- Med træk afbryder / With cord switch / Mit Schnur Schalter







Cole pendler, gulv- og væglamper, se side 4-5, 35, 94-97
 Cole pendants, floor- and wall lamps, see page 4-5, 35, 94-97
 Cole Pendeln, Boden und Wandleuchten, siehe Seite 4-5, 35, 94-97

**OBS! Skærm og fod sælges
 hver for sig
 Attention! Shade and base
 are sold separately
 Bitte beachten! Schirm und
 Fuß separat verkauft**

Cole 2 skærm I3

Cole 2 shade I3 / Cole 2 Schirm I3

Højde (cm) / Height (cm) / Höhe (cm)	40
Diameter (cm) / Diameter (cm) / Durchmesser (cm)	13
Kollistr. / Number per package / Stück pro VE	4
Skærm / Shade / Schirm	Stof / Textile / Textil

	Skærm i tekstil Shade textile Schirm Textil	Fod Base Fuss	Transformer Transformer Transformer	Dæmper Dimmer Dimmer	Varenr. Item no. Warennr.	EAN-nr. EAN-no. EAN-nr.
		Krom Chrome Chrom	- - -	- - -	13094132100	 5 705614 103257
	Hvid White Weiss				08094132020	 5 705614 103240
	Hvid plissé White pleat Weiss Plissee				08094132120	 5 705614 104537



Cole 2 bord 34 lampefod

Table 34 base / Tisch 34 Fuß

Højde m. skærm (cm) / Height w. shade(cm) / Höhe m. Schirm (cm)	51
Diameter (cm) / Diameter (cm) / Durchmesser (cm)	34
Volt / Voltage / Volt	230V
Antal lyskilder / Number of bulbs / Anzahl Birnen	1
Lyskilde / Light source / Licht	60W E27
Alt. lyskilde / Alt. Light source / Alternativ Licht	11-13W E27 CFL
Ledning / Cable / Kabel	2 m.
Kollistr. / Number per package / Stück pro VE	4

- Ledning i grå tekstil / Cable in grey textile / Kabel in grauen Textil
- Lampen leveres ekskl. lyskilde / Bulb not included / Exklusiv Birne
- Med træk afbryder / With cord switch / Mit Schnur Schalter



Cole pendler, gulv- og væglamper, se side 4-5, 35, 94-97
 Cole pendants, floor- and wall lamps, see page 4-5, 35, 94-97
 Cole Pendeln, Boden und Wandleuchten, siehe Seite 4-5, 35, 94-97

OBS! Skærm og fod sælges hver for sig
Attention! Shade and base are sold separately
Bitte beachten! Schirm und Fuß separat verkauft

Cole 2 bord 34 skærm

Shade 34 cm / Schirm 34 cm

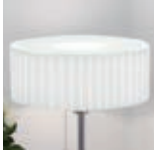
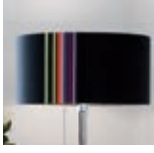
Højde (cm) / Height (cm) / Höhe (cm)	13,5
Diameter (cm) / Diameter (cm) / Durchmesser (cm)	34
Kollistr. / Number per package / Stück pro VE	4
Skærm / Shade / Schirm	Stof / Textile / Textil

	Skærm i tekstil Shade textile Schirm Textil	Fod Base Fuss	Transformer Transformer Transformer	Dæmper Dimmer Dimmer	Varenr. Item no. Warennr.	EAN-nr. EAN-no. EAN-nr.
		Krom Chrome Chrom	- - -	- - -	13094342100	 5 705614 103219
	Hvid White Weiss				08094342020	 5 705614 103226
	Hvid plissé White pleat Weiss Plissee				08094342120	 5 705614 104544
	Sort contrast Black contrast Schwarz contrast				08094342073	 5 705614 103233

Curve bord

Table / Tisch

Højde (cm) / Height (cm) / Höhe (cm)	41
Diameter (cm) / Diameter (cm) / Durchmesser (cm)	11,5
Volt / Voltage / Volt	230V
Antal lyskilder / Number of bulbs / Anzahl Birnen	1
Lyskilde / Light source / Licht	25W G9
Ledning / Cable / Kabel	2 m
Kollistr. / Number per package / Stück pro VE	6

- Klar PVC ledning med afbryder / Clear PCV cable with switch /
Durchsichtigem Kunststoff Kabel mit Schalter
- Tilbehør: Magnetisk vingemøtrik / Accessory: Magnetic wing nut /
Zubehör: Magnetisch Flügelmutter



	Skærm Shade Schirm	Fod Base Fuss	Transformer Transformer Transformer	Dæmper Dimmer Dimmer	Varenr. Item no. Warennr.	EAN-nr. EAN-no. EAN-nr.
	Hvid metal White metal Weiß Metall	Hvid White Weiß	– – –	– – –	13017092020	 5 705614 107651
	Hvid metal White metal Weiß Metall	Krom Chrome Chrom	– – –	– – –	13017090120	 5 705614 109525
	Sort metal Black metal Schwarz Metall	Sort Black Schwarz	– – –	– – –	13017090520	 5 705614 107668
	Lime metal Lime metal Lime Metall	Lime Lime Limette	– – –	– – –	13017095320	 5 705614 107682
	Lilla metal Purple metal Purpur Metall	Lilla Purple Purpur	– – –	– – –	13017095420	 5 705614 107705

Enigma bord

Table / Tisch

Højde (cm) / Height (cm) / Höhe (cm)	18,5
Diameter (cm) / Diameter (cm) / Durchmesser (cm)	9
Volt / Voltage / Volt	230V
Antal lyskilder / Number of bulbs / Anzahl Birnen	1
Lyskilde / Light source / Licht	40W E14
Alt. lyskilde / Alt. Light source / Alternativ Licht	7-9W E14 CFL
Ledning / Cable / Kabel	2 m
Kollistr. / Number per package / Stück pro VE	6

- Lampen leveres med henholdsvis hvid og sort PVC ledning / The lamp comes with, respectively white or black PVC cable / Die Lampe wird mit jeweils weißes und schwarzen Kunststoff-Kabel geliefert
- Lampen leveres ekskl. lyskilde / Bulb not included / Exklusiv Birne
- Med afbryder på Fod / With switch on the Base / Mit Schalter auf der Fuss



	Skærm Shade Schirm	Fod Base Fuss	Transformer Transformer Transformer	Dæmper Dimmer Dimmer	Varenr. Item no. Warennr.	EAN-nr. EAN-no. EAN-nr.
	Hvid glas White glass Weiß Glas	Sort Black Schwarz	– – –	– – –	13024140005	 5 705614 111146
	Hvid glas White glass Weiß Glas	Hvid White Weiß	– – –	– – –	13024140020	 5 705614 111153



Diva



Diva bord

Table / Tisch

Højde (cm) / Height (cm) / Höhe (cm)	52
Bredde (cm) / Width (cm) / Breite (cm)	47
Diameter (cm) / Diameter (cm) / Durchmesser (cm)	13
Volt / Voltage / Volt	230V
Antal lyskilder / Number of bulbs / Anzahl Birnen	1
Lyskilde / Light source / Licht	8W E14 CFL
Ledning / Cable / Kabel	2 m
Kollistr: / Number per package / Stück pro VE	4

- Hvid PVC ledning med afbryder på Diva hvid og lime / White PCV cable with switch on Diva white and lime / Weiß Kunststoff Kabel mit Schalter auf Diva weiß und Lime
- Sort PVC ledning med afbryder på Diva sort, rød og lilla / Black PCV cable with switch on Diva black, red and purple / Schwarz Kunststoff Kabel mit Schalter auf Diva schwarz, rot und purpur
- Lampen leveres ekskl. lyskilde / Bulb not included / Exklusiv Birne



Diva gulv- og væglamper, se side 38-39, 98
Diva floor- and wall lamps, see page 38-39, 98
Diva Boden und Wandleuchten, siehe Seite 38-39, 98

	Skærm Shade Schirm	Fod Base Fuss	Transformer Transformer Transformer	Dæmper Dimmer Dimmer	Varenr. Item no. Warennr.	EAN-nr. EAN-no. EAN-nr.
	Sort metal Black metal Schwarz Metall	Sort metal Black metal Schwarz Metall	- - -	- - -	13014270105	 5 705614 102878
	Hvid metal White metal Weiß Metall	Hvid metal White metal Weiß Metall	- - -	- - -	13014270120	 5 705614 104230
	Lime metal Lime metal Lime Metall	Lime metal Lime metal Lime Metall	- - -	- - -	13014270153	 5 705614 105138
	Rød metal Red metal Rot Metall	Rød metal Red metal Rot Metall	- - -	- - -	13014270134	 5 705614 105244
	Lilla metal Purple metal Purpur Metall	Lilla metal Purple metal Purpur Metall	- - -	- - -	13014270154	 5 705614 105275



Events basic bord

Table / Tisch

Højde (cm) / Height (cm) / Höhe (cm)	23
Diameter (cm) / Diameter (cm) / Durchmesser (cm)	13
Volt / Voltage / Volt	230V
Antal lyskilder / Number of bulbs / Anzahl Birnen	1
Lyskilde / Light source / Licht	40W E14
Alt. lyskilde / Alt. Light source / Alternativ Licht	7-9W E14 CFL
Ledning / Cable / Kabel	2 m
Kollistr. / Number per package / Stück pro VE	4

- Sort PVC ledning med afbryder / Black PVC cable with switch / Schwarzes Kunststoffkabel mit Schalter
- Lampen leveres ekskl. lyskilde / Bulb not included / Exklusiv Birne

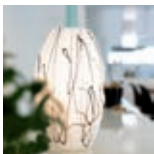

	Skærm Shade Schirm	Fod Base Fuss	Transformer Transformer Transformer	Dæmper Dimmer Dimmer	Varenr. Item no. Warennr.	EAN-nr. EAN-no. EAN-nr.
	Contrast glas Contrast glass Contrast Glas	– – –	– – –	– – –	13053140088	 5 705614 095101

Gil bord

Table / Tisch

Højde (cm) / Height (cm) / Höhe (cm)	37
Diameter (cm) / Diameter (cm) / Durchmesser (cm)	9,5
Volt / Voltage / Volt	230V
Antal lyskilder / Number of bulbs / Anzahl Birnen	1
Lyskilde / Light source / Licht	25W G9
Kollistr: / Number per package / Stück pro VE	6



- Sort PVC ledning med afbryder / Black PVC cable with switch /
Schwarzes Kunststoffkabel mit Schalter

Gil væglamper og krone, se side 28, 43

Gil wall lamps and chandelier, see page 28, 43

Gil wandleuchte und Kronleuchte, siehe Seite 28, 43



	Skærm Shade Schirm	Fod Base Fuss	Transformer Transformer Transformer	Dæmper Dimmer Dimmer	Varen: Item no. Warennr.	EAN-nr: EAN-no. EAN-nr.
	Hvid glas White glass Weiß Glas	Krom Chrome Chrom	- - -	- - -	13057190120	 5 705614 085546
	Contrast glas Contrast glass Contrast Glas	Krom Chrome Chrom	- - -	- - -	13057190188	 5 705614 095378

Leika bordlampe fod krom



Table / Tisch

Højde m. skærm (cm) / Height w. shade(cm) / Höhe m. Schirm (cm)	54
Diameter (cm) / Diameter (cm) / Durchmesser (cm)	18
Volt / Voltage / Volt	230V
Antal lyskilder / Number of bulbs / Anzahl Birnen	1
Lyskilde / Light source / Licht	40W E14
Alt. lyskilde / Alt. Light source / Alternativ Licht	7-9W E14 CFL
Ledning / Cable / Kabel	2 m
Kollistr. / Number per package / Stück pro VE	4

- Lampen leveres ekskl. lyskilde / Bulb not included / Exklusiv Birne
- Sælges kun i hele kolli / For sale only in full collies / Nur in ganzen VE verkaufbar
- Sort PVC ledning med afbryder / Black PVC cable with switch / Schwarzes Kunststoffkabel mit Schalter



Leika gulvlampe, se side 100
 Leika floor lamp, see page 100
 Leika Bodenleuchte, siehe Seite 100

	Skærm Shade Schirm	Fod Base Fuss	Transformer Transformer Transformer	Dæmper Dimmer Dimmer	Varenr: Item no. Warennr.	EAN-nr: EAN-no. EAN-nr.
	- - -	Krom Chrome Chrom	- - -	- - -	13091140100	 5 705614 101482

**OBS! Skærm og fod sælges
 hver for sig
 Attention! Shade and base
 are sold separately
 Bitte beachten! Schirm und
 Fuß separat verkauft**

Leika cone skærm













Shade 18 x 13 / Schirm 18 x 13

Højde (cm) / Height (cm) / Höhe (cm) 18
 Diameter (cm) / Diameter (cm) / Durchmesser (cm) 13 / 18
 Kollistr. / Number per package / Stück pro VE 4
 Skærm / Shade / Schirm Stof / Textile / Textil

- Sælges kun i hele kolli / For sale only in full collies / Nur in ganzen VE verkaufbar

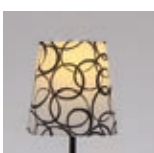
Leika gulvlampe, se side 100
 Leika floor lamp, see page 100
 Leika Bodenleuchte, siehe Seite 100



	Skærm i tekstil Shade textile Schirm Textil	Fod Base Fuss	Transformer Transformer Transformer	Dæmper Dimmer Dimmer	Varenr. Item no. Warennr.	EAN-nr. EAN-no. EAN-nr.
	Sort Black Schwarz				08091141005	 5 705614 105046
	Hvid White Weiß				08091141020	 5 705614 101444
	Lilla Purple Purpur				08091141054	 5 705614 101468
	Sand Beige Beige				08091141063	 5 705614 101451
	Stinna Stinna Stinna				08091141085	 5 705614 101475
	Felice Felice Felice				08091141090	 5 705614 105053



Lyon bord

Table / Tisch

Højde (cm) / Height (cm) / Höhe (cm)	70
Diameter (cm) / Diameter (cm) / Durchmesser (cm)	35
Volt / Voltage / Volt	230V
Antal lyskilder / Number of bulbs / Anzahl Birnen	1
Lyskilde / Light source / Licht	60W E27
Alt. lyskilde / Alt. Light source / Alternativ Licht	11-13W E27 CFL
Ledning / Cable / Kabel	2 m
Kollistr. / Number per package / Stück pro VE	4
Skærm / Shade / Schirm	Stof / Textile / Textil

- Hvid PVC ledning med afbryder / White PVC cable with switch / Weiße Kunststoffkabel mit Schalter
- Lampen leveres ekskl. lyskilde / Bulb not included / Exklusiv Birne
- Lampefoden er fremstillet i polyresin / Base made of polyresin / Fuß aus Polyresin



	Skærm i tekstil Shade textile Schirm Textil	Fod Base Fuss	Transformer Transformer Transformer	Dæmper Dimmer Dimmer	Varenr. Item no. Warennr.	EAN-nr. EAN-no. EAN-nr.
	Hvid White Weiß	Hvid White Weiß	– – –	– – –	YZ02338W-2	 5 705614 109754

Lyon gulvlampe, se side 104
Lyon floorlamp, see page 104
Lyon Bodenleuchte, siehe Seite 104



Nice bord

Table / Tisch

Højde (cm) / Height (cm) / Höhe (cm)	67,5
Diameter (cm) / Diameter (cm) / Durchmesser (cm)	35
Volt / Voltage / Volt	230V
Antal lyskilder / Number of bulbs / Anzahl Birnen	1
Lyskilde / Light source / Licht	60W E27
Alt. lyskilde / Alt. Light source / Alternativ Licht	11-13W E27 CFL
Ledning / Cable / Kabel	2 m
Kollistr. / Number per package / Stück pro VE	4
Skærm / Shade / Schirm	Stof / Textile / Textil

- Hvid PVC ledning med afbryder / White PVC cable with switch / Weiße Kunststoffkabel mit Schalter
- Lampen leveres ekskl. lyskilde / Bulb not included / Exklusiv Birne
- Lampefoden er fremstillet i polyresin / Base made of polyresin / Fuß aus Polyresin



	Skærm Shade Schirm	Fod Base Fuss	Transformer Transformer Transformer	Dæmper Dimmer Dimmer	Varenr. Item no. Warennr.	EAN-nr. EAN-no. EAN-nr.
	Hvid White Weiß		– – –	– – –	YZ02790W-4	 5 705614 109747

Nice gulvlampe, se side 105
 Nice floorlamp, see page 105
 Nice Bodenleuchte, siehe Seite 105



Micro Zenta bord

Table / Tisch

Højde (cm) / Height (cm) / Höhe (cm)	44
Diameter (cm) / Diameter (cm) / Durchmesser (cm)	9
Volt / Voltage / Volt	230V~12V
Antal lyskilder / Number of bulbs / Anzahl Birnen	2
Lyskilde / Light source / Licht	20W G4
Ledning / Cable / Kabel	2,5 m
Kollistr: / Number per package / Stück pro VE	4

- Sort PVC ledning / Black PVC cable / Schwarzes Kunststoffkabel



	Skærm Shade Schirm	Fod Base Fuss	Transformer Transformer Transformer	Dæmper Dimmer Dimmer	Varenr: Item no. Warennr.	EAN-nr: EAN-no. EAN-nr.
	Hvid glas White glass Weiss Glas	Krom Chrome Chrom	20-50 VA 20-50 VA 20-50 VA	Skyde Sliding Verschiebbar	13075040120	 5 705614 100539

Zenta gulvlampe, se side 114
 Zenta floorlamp, see page 114
 Zenta Bodenleuchte, siehe Seite 114

Mini Tube bord

Table / Tisch

Højde (cm) / Height (cm) / Höhe (cm)	42
Diameter (cm) / Diameter (cm) / Durchmesser (cm)	5
Volt / Voltage / Volt	230V
Antal lyskilder / Number of bulbs / Anzahl Birnen	1
Lyskilde / Light source / Licht	40W E14
Alt. lyskilde / Alt. Light source / Alternativ Licht	7-9W E14 CFL
Ledning / Cable / Kabel	2 m
Kollistr. / Number per package / Stück pro VE	10

- Sort PVC ledning med afbryder / Black PVC cable with switch / Schwarzes Kunststoffkabel mit Schalter
- Lampen leveres ekskl. lyskilde / Bulb not included / Exklusiv Birne





	Skærm Shade Schirm	Fod Base Fuss	Transformer Transformer Transformer	Dæmper Dimmer Dimmer	Varenr: Item no. Warennr.	EAN-nr: EAN-no. EAN-nr.
	Hvid glas White glass Weiss Glas	Krom Chrome Chrom	– – –	– – –	13068023020	 5 705614 064053
	Contrast glas Contrast glass Contrast Glas	Krom Chrome Chrom	– – –	– – –	13068023088	 5 705614 095613

Miniature Basic Tube Trio bord Table / Tisch

Højde (cm) / Height (cm) / Höhe (cm)	19,5 - 24 - 29,5
Diameter (cm) / Diameter (cm) / Durchmesser (cm)	5
Volt / Voltage / Volt	230V
Antal lyskilder / Number of bulbs / Anzahl Birnen	3
Lyskilde / Light source / Licht	40W E14
Alt. lyskilde / Alt. Light source / Alternativ Licht	7-9W E14 CFL
Ledning / Cable / Kabel	2 m
Kollistr. / Number per package / Stück pro VE	10

- Hvid PVC ledning med afbryder / White PVC cable with switch / Weiße Kunststoffkabel mit Schalter
- Lampen leveres ekskl. lyskilde / Bulb not included / Exklusiv Birne



	Skærm Shade Schirm	Fod Base Fuss	Transformer Transformer Transformer	Dæmper Dimmer Dimmer	Varenr: Item no. Warennr.	EAN-nr: EAN-no. EAN-nr.
	Hvid glas White glass Weiß Glas	Krom Chrome Chrom	– – –	– – –	13067030120	 5 705614 071693



Tube Trio bord

Table / Tisch

Højde (cm) / Height (cm) / Höhe (cm)	19,5 - 24 - 29,5
Diameter (cm) / Diameter (cm) / Durchmesser (cm)	5
Volt / Voltage / Volt	230V
Antal lyskilder / Number of bulbs / Anzahl Birnen	3
Lyskilde / Light source / Licht	40W E14
Alt. lyskilde / Alt. Light source / Alternativ Licht	7-9W E14 CFL
Kollistr. / Number per package / Stück pro VE	8

- Hvid PVC ledning med afbryder / White PVC cable with switch / Weiße Kunststoffkabel mit Schalter
- Lampen leveres ekskl. lyskilde / Bulb not included / Exklusiv Birne



	Skærm Shade Schirm	Fod Base Fuss	Transformer Transformer Transformer	Dæmper Dimmer Dimmer	Varenr: Item no. Warennr.	EAN-nr: EAN-no. EAN-nr.
	Contrast glas Contrast glass Contrast Glas	Krom Chrome Chrom	- - -	- - -	13067030188	 5 705614 091660

Neptun bord

Table / Tisch

Højde (cm) / Height (cm) / Höhe (cm)	28
Antal lyskilder / Number of bulbs / Anzahl Birnen	1
Lyskilde / Light source / Licht	2,5W LED
Kollistr: / Number per package / Stück pro VE	4

- Grå PVC ledning med plug in LED driver på Neptun hvid / White PVC cable with plug in LED driver on Neptun white / Weißes Kunststoffkabel in mit LED Stecker auf Neptun weiß
- Sort PVC ledning med plug in LED driver på Neptun sort, lime, rød og lilla / Black PVC cable with plug in LED driver on Neptun black, lime, red and purple / Schwarzes Kunststoffkabel in mit LED Stecker auf Neptun schwarz, lime, rot und purpur
- Med afbryder på ledningen / With switch on the cable / Mit Schalter auf das Kabel



Neptun gulv- og væglamper, se side 52, 106
 Neptun floor- and wall lamps, see page 52, 106
 Neptun Boden und Wandleuchten, siehe Seite 52, 106

	Skærm Shade Schirm	Fod Base Fuss	Transformer Transformer Transformer	Dæmper Dimmer Dimmer	Varenr: Item no. Warennr.	EAN-nr. EAN-no. EAN-nr.
	Sort Black Schwarz	Sort Black Schwarz	LED driver	– – –	13012010505	 5 705614 104292
	Hvid White Weiß	Hvid White Weiß	LED driver	– – –	13012012020	 5 705614 104322
	Lime Lime Limette	Lime Lime Limette	LED driver	– – –	13012015353	 5 705614 106456
	Rød Red Rot	Rød Red Rot	LED driver	– – –	13012013434	 5 705614 106463
	Lilla Purple Purpur	Lilla Purple Purpur	LED driver	– – –	13012015454	 5 705614 106470



New Gil II Grande bord

Table / Tisch

Højde (cm) / Height (cm) / Höhe (cm)	37
Diameter (cm) / Diameter (cm) / Durchmesser (cm)	14
Volt / Voltage / Volt	230V
Antal lyskilder / Number of bulbs / Anzahl Birnen	1
Lyskilde / Light source / Licht	40W G9
Alt. lyskilde / Alt. Light source / Alternativ Licht	7-9W E14 CFL
Ledning / Cable / Kabel	2 m
Kollistr.: / Number per package / Stück pro VE	4

- Sort PVC ledning med afbryder / Black PVC cable with switch / Schwarzes Kunststoffkabel mit Schalter

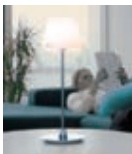

	Skærm Shade Schirm	Fod Base Fuss	Transformer Transformer Transformer	Dæmper Dimmer Dimmer	Varenr: Item no. Warennr.	EAN-nr: EAN-no. EAN-nr.
	Hvid glas White glass Weiß Glas	Krom Chrome Chrom	– – –	– – –	13062490120	 5 705614 085881





Spirit bord

Table / Tisch

Højde (cm) / Height (cm) / Höhe (cm)	53,2
Bredde (cm) / Width (cm) / Breite (cm)	54,4
Volt / Voltage / Volt	230V~12V
Antal lyskilder / Number of bulbs / Anzahl Birnen	1
Lyskilde / Light source / Licht	35W Gy6,35
Ledning / Cable / Kabel	2 m
Kollistr. / Number per package / Stück pro VE	4

- Sort PVC ledning med afbryder / Black PVC cable with switch / Schwarzes Kunststoffkabel mit Schalter



	Skærm Shade Schirm	Fod Base Fuss	Transformer Transformer Transformer	Dæmper Dimmer Dimmer	Varenr. Item no. Warennr.	EAN-nr. EAN-no. EAN-nr.
	Hvid White Weiß	Krom Chrome Chrom	Electronic plug in	– – –	13022010120	 5 705614 109556
	Sort Black Schwarz	Krom Chrome Chrom	Electronic plug in	– – –	13022010105	 5 705614 109563

Spirit pendel, gulv- og væglampe, se side 24, 58, 107

Spirit pendant, floor- and wall lamp, see page 24, 58, 107

Spirit Pendel, Boden- und Wandleuchte, siehe Seite 24, 58, 107

Straight bord

Table / Tisch

Højde (cm) / Height (cm) / Höhe (cm)	63
Antal lyskilder / Number of bulbs / Anzahl Birnen	1
Volt / Voltage / Volt	230V
Lyskilde / Light source / Licht	15W E27 CFL
Ledning / Cable / Kabel	2 m
Kollistr.: / Number per package / Stück pro VE	4

- Hvid PVC ledning på Straight hvid / White PCV cable on Straight white / Weiß Kunststoff Kabel auf Straight weiß
- Sort PVC ledning på Straight sort, sølv og lime / Black PCV cable on Straight black, silver and lime / Schwarz Kunststoff Kabel auf Straight schwarz, silber und lime
- Lampen leveres ekskl. lyskilde / Bulb not included / Exklusiv Birne
- Med afbryder på skærm / With switch on the shade / Mit Schalter auf das Schirm

Straight gulv- og væglampe, se side 59, 108

Straight floor- and wall lamp, see page 59, 108

Straight Boden- und Wandleuchte, siehe Seite 59, 108



	Skærm Shade Schirm	Fod Base Fuss	Transformer Transformer Transformer	Dæmper Dimmer Dimmer	Varenr. Item no. Warennr.	EAN-nr. EAN-no. EAN-nr.
	Sort metal Black metal Schwarz Metall	Sort metal Black metal Schwarz Metall	– – –	– – –	13019270105	 5 705614 107057
	Hvid metal White metal Weiss Metall	Hvid metal White metal Weiss Metall	– – –	– – –	13019270120	 5 705614 107064
	Sølvgrå metal Silver metal Silber Metall	Sølvgrå metal Silver metal Silber Metall	– – –	– – –	13019270106	 5 705614 107073
	Lime metal Lime metal Limette Metall	Lime metal Lime metal Limette Metall	– – –	– – –	13019270153	 5 705614 107071

Vienda bord



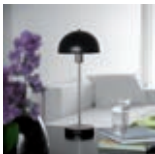



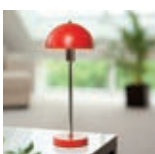

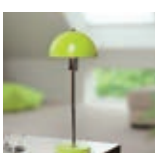



Table / Tisch

Højde (cm) / Height (cm) / Höhe (cm)	47,5
Diameter (cm) / Diameter (cm) / Durchmesser (cm)	19,5
Volt / Voltage / Volt	230V
Lyskilde / Light source / Licht	1 X 40W E14
Alt. lyskilde / Alt. Light source / Alternativ Licht	1 X 7-9W E14 CFL
Ledning / Cable / Kabel	2 m
Kollistri: / Number per package / Stück pro VE	6

- Hvid PVC ledning på Vienda hvid og hvid glas / White PVC cable on Vienda white and white glass / Weißes Kunststoffkabel auf Vienda weiß und weiß Glas
- Sort PVC ledning på Vienda sort, lime, rød og lilla / Black PVC cable on Vienda black, lime, red and purple / Schwarzes Kunststoffkabel auf Vienda schwarz, lime, rot und purpur
- Lampen leveres ekskl. lyskilde / Bulb not included / Exklusiv Birne



Vienda pendel og gulvlampe, se side 25, 113
Vienda pendant and floor lamp, see page 25, 113
Vienda Pendeln und Bodenleuchte, siehe Seite 25, 113

	Skærm Shade Schirm	Fod Base Fuss	Transformer Transformer Transformer	Dæmper Dimmer Dimmer	Varenr. Item no. Warennr.	EAN-nr. EAN-no. EAN-nr.
	Hvid glas White glass Weiss Glas	Krom Chrome Chrom	– – –	– – –	13071140106	 5 705614 090045
	Sort metal Black metal Schwarz Metall	Sort Black Schwarz	– – –	– – –	13071140105	 5 705614 105183
	Hvid metal White metal Weiss Metall	Hvid White Weiss	– – –	– – –	13071140120	 5 705614 105176
	Rød metal Red metal Rot Metall	Rød Red Rot	– – –	– – –	13071140134	 5 705614 105855
	Lime metal Lime metal Limette Metall	Lime Lime Limette	– – –	– – –	13071140153	 5 705614 105831
	Lilla metal Purple metal Purpur Metall	Lilla Purple Purpur	– – –	– – –	13071140154	 5 705614 105848

GULVLAMPER
FLOOR LAMPS
BODENLEUCHTEN

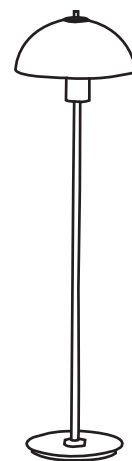

Archi Cut gulv

Floor / Boden

Højde (cm) / Height (cm) / Höhe (cm)	121
Diameter (cm) / Diameter (cm) / Durchmesser (cm)	10,5
Volt / Voltage / Volt	230V~12V
Antal lyskilder / Number of bulbs / Anzahl Birnen	2
Lyskilde / Light source / Licht	20W G4
Ledning / Cable / Kabel	2 m
Kollistr: / Number per package / Stück pro VE	2

- Sort PVC ledning med afbryder / Black PVC cable with switch / Schwarzes Kunststoffkabel mit Schalter

Cut væg og track, se side 36-37, 120

Cut wall and track, see page 36-37, 120

Cut Wand und Track, siehe Seite 36-37, 120



	Skærm Shade Schirm	Finish Finish Finish	Transformer Transformer Transformer	Dæmper Dimmer Dimmer	Varenr: Item no. Warennr.	EAN-nr: EAN-no. EAN-nr.
	Hvid White Weiss	Krom Chrome Chrom	20-60 VA 20-60 VA 20-60 VA	Skyde Sliding Verschiebbar	I4072290120SR	 5 705614 090526
	Contrast Contrast Contrast	Krom Chrome Chrom	20-60 VA 20-60 VA 20-60 VA	Skyde Sliding Verschiebbar	I4072290188SR	 5 705614 098690

Archi Harlekin gulv

Floor / Boden

Højde (cm) / Height (cm) / Höhe (cm)	121
Diameter (cm) / Diameter (cm) / Durchmesser (cm)	7
Volt / Voltage / Volt	230V~12V
Antal lyskilder / Number of bulbs / Anzahl Birnen	2
Lyskilde / Light source / Licht	20W G4
Ledning / Cable / Kabel	2 m
Kollistr: / Number per package / Stück pro VE	2

- Sort PVC ledning med afbryder / Black PVC cable with switch / Schwarzes Kunststoffkabel mit Schalter

Razz Mini Harlekin væg, se side 53

Razz Mini Harlekin wall, see page 53

Razz Mini Harlekin Wand, siehe Seite 53



	Skærm Shade Schirm	Finish Finish Finish	Transformer Transformer Transformer	Dæmper Dimmer Dimmer	Varenr: Item no. Warennr.	EAN-nr: EAN-no. EAN-nr.
	Hvid White Weiss	Krom Chrome Chrom	20-60 VA 20-60 VA 20-60 VA	Skyde Sliding Verschiebbar	I4054290120SR	 5 705614 090519
	Contrast Contrast Contrast	Krom Chrome Chrom	20-60 VA 20-60 VA 20-60 VA	Skyde Sliding Verschiebbar	I4054290188SR	 5 705614 098683



Barla gulvlampefod sort

Floor / Boden

Højde m. skærm (cm) / Height w. shade(cm) / Höhe m. Schirm (cm)	159
Bredde (cm) / Width (cm) / Breite (cm)	57
Volt / Voltage / Volt	230V
Antal lyskilder / Number of bulbs / Anzahl Birnen	1
Lyskilde / Light source / Licht	60W E27
Alt. lyskilde / Alt. Light source / Alternativ Licht	11-13W E27 CFL
Ledning / Cable / Kabel	2,5 m
Kollistr: / Number per package / Stück pro VE	1

- Lampen leveres eksl. lyskilde / Bulb not included / Exklusiv Birne
- Kun lampefod / Only base / Nur Fuss
- Grå textilledning med afbryder / Grey textile cable with switch / Grauer Textilkabel mit Schalter



	Skærm Shade Schirm	Finish Finish Finish	Transformer Transformer Transformer	Dæmper Dimmer Dimmer	Varenr: Item no. Warennr.	EAN-nr: EAN-no. EAN-nr.
	–	Sort Black Schwarz	–	–	14084270500	 5 705614 105428

OBS! Skærm og fod sælges hver for sig
Attention! Shade and base are sold separately
Bitte beachten! Schirm und Fuß separat verkauft

Barla skærm

Shade / Schirm

Højde (cm) / Height (cm) / Höhe (cm) 32
 Diameter (cm) / Diameter (cm) / Durchmesser (cm) 61
 Kollistr. / Number per package / Stück pro VE 1

- Kun skærm / Nur Schirm / Only shade



	Skærm i tekstil Shade textile Schirm Textil	Finish Finish Finish	Transformer Transformer Transformer	Dæmper Dimmer Dimmer	Varenr. Item no. Warennr.	EAN-nr. EAN-no. EAN-nr.
	Hvid White Weiß				08084000020	 5 705614 105442
	Sand Beige Beige				08084000063	 5 705614 105459
	Net sand Net beige Netz beige				08084000071	 5 705614 105466
	Sort contrast Black contrast Schwarz contrast				08084000073	 5 705614 105435
	Felice Felice Felice				08084000090	 5 705614 105473

Cole 2 gulv 17 uden skærm



Floor without shade / Boden ohne Schirm

Højde m. skærm (cm) / Height w. shade(cm) / Höhe m. Schirm (cm)	131
Diameter (cm) / Diameter (cm) / Durchmesser (cm)	17
Volt / Voltage / Volt	230V
Antal lyskilder / Number of bulbs / Anzahl Birnen	2
Lyskilde / Light source / Licht	40W E14
Alt. lyskilde / Alt. Light source / Alternativ Licht	7-9W E14 CFL
Ledning / Cable / Kabel	2 m
Kollistr. / Number per package / Stück pro VE	2

- Lampen leveres ekskl. lyskilde / Bulb not included / Exklusiv Birne
- Kun lampefod / Only base / Nur Fuss
- Grå textilledning med afbryder / Grey textile cable with switch / Grauer Textilkabel mit Schalter

Cole pendler, bord- og væglamper, se side 4-5, 35, 66-69
 Cole pendants, table- and wall lamps, see page 4-5, 35, 66-69
 Cole Pendeln, Tisch- und Wandleuchten, siehe Seite 4-5, 35, 66-69



	Skærm Shade Schirm	Finish Finish Finish	Transformer Transformer Transformer	Dæmper Dimmer Dimmer	Varenr: Item no. Warennr.	EAN-nr: EAN-no. EAN-nr.
	–	Krom Chrome Chrom	–	–	14094172100	 5 705614 103301

OBS! Skærm og fod sælges hver for sig
Attention! Shade and base are sold separately
Bitte beachten! Schirm und Fuß separat verkauft

Cole 2 skærm 17

Shade 17 cm / Schirm 17 cm

Højde (cm) / Height (cm) / Höhe (cm) 100
 Diameter (cm) / Diameter (cm) / Durchmesser (cm) 17
 Kollistr. / Number per package / Stück pro VE 4

- Kun skærm / Only shade / Nur Schirm

Cole pendler, bord- og væglamper, se side 4-5, 35, 66-69
 Cole pendants, table- and wall lamps, see page 4-5, 35, 66-69
 Cole Pendeln, Tisch- und Wandleuchten, siehe Seite 4-5, 35, 66-69



	Skærm i tekstil Shade textile Schirm Textil	Finish Finish Finish	Transformer Transformer Transformer	Dæmper Dimmer Dimmer	Varenr: Item no. Warennr.	EAN-nr: EAN-no. EAN-nr.
	Hvid White Weiß				08094172020	 5 705614 103295
	Hvid plissé White pleat Weiß Plissee					 5 705614 104551

Cole 2 gulv 50 uden skærm

Floor without shade / Boden ohne Schirm

Højde m. skærm (cm) / Height w. shade(cm) / Höhe m. Schirm (cm)	148,5
Diameter (cm) / Diameter (cm) / Durchmesser (cm)	50
Volt / Voltage / Volt	230V
Antal lyskilder / Number of bulbs / Anzahl Birnen	1
Lyskilde / Light source / Licht	60W E27
Alt. lyskilde / Alt. Light source / Alternativ Licht	11-13W E27 CFL
Ledning / Cable / Kabel	2 m
Kollistr. / Number per package / Stück pro VE	2



- Lampen leveres ekskl. lyskilde / Bulb not included / Exklusiv Birne
- Kun lampefod / Only base / Nur Fuss
- Grå textilledning / Grey textile cable / Grauer Textilkabel
- Med træk afbryder / With cord switch / Mit Schnur Schalter

Cole pendler, bord- og væglamper, se side 4-5, 35, 66-69

Cole pendants, table- and wall lamps, see page 4-5, 35, 66-69

Cole Pendeln, Tisch- und Wandleuchten, siehe Seite 4-5, 35, 66-69

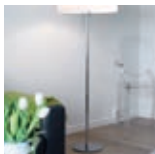

	Skærm Shade Schirm	Finish Finish Finish	Transformer Transformer Transformer	Dæmper Dimmer Dimmer	Varenr: Item no. Warennr.	EAN-nr: EAN-no. EAN-nr.
	–	Krom Chrome Chrom	–	–	14094502100	 5 705614 103264

OBS! Skærm og fod sælges hver for sig
Attention! Shade and base are sold separately
Bitte beachten! Schirm und Fuß separat verkauft

Cole 2 skærm 50

Shade 50 cm / Schirm 50 cm

Højde (cm) / Height (cm) / Höhe (cm)	25
Diameter (cm) / Diameter (cm) / Durchmesser (cm)	50
Kollistr. / Number per package / Stück pro VE	2





- Kun skærm / Only shade / Nur Schirm

Cole pendler, bord- og væglamper, se side 4-5, 35, 66-69

Cole pendants, table- and wall lamps, see page 4-5, 35, 66-69

Cole Pendeln, Tisch- und Wandleuchten, siehe Seite 4-5, 35, 66-69

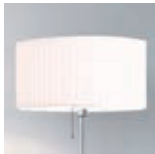

	Skærm i tekstil Shade textile Schirm Textil	Finish Finish Finish	Transformer Transformer Transformer	Dæmper Dimmer Dimmer	Varenr: Item no. Warennr.	EAN-nr: EAN-no. EAN-nr.
	Hvid White Weiß				08094502020	 5 705614 103271
	Hvid plissé White pleat Weiß Plissee				80904500020	 5 705614 094623
	Sort contrast Black contrast Schwarz contrast				0809452073	 5 705614 103288

Diva gulv

Floor / Boden

Højde (cm) / Height (cm) / Höhe (cm)	135
Bredde (cm) / Width (cm) / Breite (cm)	50
Diameter (cm) / Diameter (cm) / Durchmesser (cm)	18
Volt / Voltage / Volt	230V
Antal lyskilder / Number of bulbs / Anzahl Birnen	1
Lyskilde / Light source / Licht	E14 CFL 8W
Ledning / Cable / Kabel	2 m
Kollistr: / Number per package / Stück pro VE	4

- Lampen leveres ekskl. lyskilde / Bulb not included / Exklusiv Birne
- Hvid PVC ledning med afbryder på Diva hvid / White PCV cable with switch on Diva white / Weiß Kunststoff Kabel mit Schalter auf Diva weiß
- Sort PVC ledning med afbryder på Diva sort, rød, lime og lilla / Black PCV cable with switch on Diva black, red, lime and purple / Schwarz Kunststoff Kabel mit Schalter auf Diva schwarz, rot, lime und purpur
- Kun sparepærer må anvendes / Only CFL allowed / Nur energiesparenbirne erlaubt



Diva bord- og væglamper, se side 38-39, 71
 Diva table- and wall lamps, see page 38-39, 71
 Diva Tisch und Wandleuchten, siehe Seite 38-39, 71

	Skærm Shade Schirm	Finish Finish Finish	Transformer Transformer Transformer	Dæmper Dimmer Dimmer	Varenr: Item no. Warennr.	EAN-nr: EAN-no. EAN-nr.
	Sort metal Black metal Schwarz Metall	Krom Chrome Chrom	- - -	- - -	14014280105	 5 705614 104759
	Hvid metal White metal Weiß Metall	Krom Chrome Chrom	- - -	- - -	14014280120	 5 705614 104766
	Lime metal Lime metal Lime Metall	Krom Chrome Chrom	- - -	- - -	14014280153	 5 705614 105145
	Rød metal Red metal Rot Metall	Krom Chrome Chrom	- - -	- - -	14014280134	 5 705614 105312
	Lilla metal Purple metal Purpur Metall	Krom Chrome Chrom	- - -	- - -	14014280154	 5 705614 105305

Grass gulv

Floor / Boden

Højde (cm) / Height (cm) / Höhe (cm)	161
Diameter (cm) / Diameter (cm) / Durchmesser (cm)	50
Volt / Voltage / Volt	230V
Antal lyskilder / Number of bulbs / Anzahl Birnen	1
Lyskilde / Light source / Licht	E27 CLF 23W
Ledning / Cable / Kabel	2,5 m
Kollistr: / Number per package / Stück pro VE	2



- Lampen leveres eksl. lyskilde / Bulb not included / Exklusiv Birne
- Ledning i grå tekstil / Cable in grey textile / Kabel in grauen Textil
- Med træk afbryder / With cord switch / Mit Schnur Schalter

Grass pendel, se side 99

Grass pendant, see page 99

Grass Pendeln, siehe Seite 99

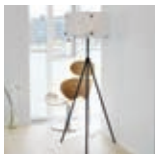

	Skærm Shade Schirm	Finish Finish Finish	Transformer Transformer Transformer	Dæmper Dimmer Dimmer	Varenr: Item no. Warennr.	EAN-nr: EAN-no. EAN-nr.
	Frosted akryl Frosted Acrylic Frostet Acryl	Sort Black Schwarz	– – –	– – –	140872701205	 5 705614 100898



Leika gulvlampefod

Base / Fuss

Højde m. skærm (cm) / Height w. shade(cm) / Höhe m. Schirm (cm)	148,5
Diameter (cm) / Diameter (cm) / Durchmesser (cm)	23
Volt /Voltage /Volt	230V
Antal lyskilder / Number of bulbs / Anzahl Birnen	1
Lyskilde / Light source / Licht	60W E27
Alt. lyskilde / Alt. Light source / Alternativ Licht	11-13W E27 CFL
Ledning / Cable / Kabel	2 m
Kollistr. / Number per package / Stück pro VE	2

- Lampen leveres ekskl. lyskilde / Bulb not included / Exklusiv Birne
- Kun lampefod / Only base / Nur Fuss
- Sort PVC ledning med afbryder / Black PVC cable with switch / Schwarzes Kunststoffkabel mit Schalter
- Sælges kun i hele kolli / For sale only in full collies / Nur in ganzen VE verkaufen

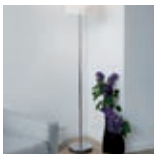

	Skærm Shade Schirm	Finish Finish Finish	Transformer Transformer Transformer	Dæmper Dimmer Dimmer	Varenr: Item no. Warennr.	EAN-nr: EAN-no. EAN-nr.
	- - -	Krom Chrome Chrom	- - -	- - -	14091270100	 5 705614 105039

OBS! Skærm og fod sælges hver for sig
Attention! Shade and base are sold separately
Bitte beachten! Schirm und Fuß separat verkauft

Leika bordlamper, se side 76
 Leika tablelamps, see page 76
 Leika Tischleuchten, siehe Seite 76

Leika cone skærm, gulv

Shade / Schirm

Højde (cm) / Height (cm) / Höhe (cm) 30
 Diameter (cm) / Diameter (cm) / Durchmesser (cm) 35
 Kollistr. / Number per package / Stück pro VE 6

- Sælges kun i hele kolli / For sale only in full collies / Nur in ganzen VE verkauft



	Skærm i tekstil Shade textile Schirm Textil	Finish Finish Finish	Transformer Transformer Transformer	Dæmper Dimmer Dimmer	Varenr. Item no. Warennr.	EAN-nr. EAN-no. EAN-nr.
	Felice Felice Felice				08091271090	 5 705614 105077
	Sort Black Schwarz				08091271005	 5 705614 105060

OBS! Skærm og fod sælges hver for sig
Attention! Shade and base are sold separately
Bitte beachten! Schirm und Fuß separat verkauft

Leika bordlamper, se side 76
 Leika tablelamps, see page 76
 Leika Tischleuchten, siehe Seite 76

Lupi Kelby gulv

Floor / Boden

Højde (cm) / Height (cm) / Höhe (cm)	132
Bredde (cm) / Width (cm) / Breite (cm)	70
Diameter (cm) / Diameter (cm) / Durchmesser (cm)	24
Volt / Voltage / Volt	230V~12V
Antal lyskilder / Number of bulbs / Anzahl Birnen	1
Lyskilde / Light source / Licht	50W GY6,35
Ledning / Cable / Kabel	2 m
Kollistr. / Number per package / Stück pro VE	2









- Med afbryder på røret / With switch on the lamp / Mit Schalter auf der Leuchte
- Grå/sort textilledning / Grey/black textile cable / Grau/schwarz Textilkabel

Kelby bad, pendler og væglampe samt skinner, se side 12-14, 46-47, 110, 118, 126-128

Kelby bathroom, pendants, walllamps and tracks, see page 12-14, 46-47, 110, 118, 126-128

Kelby badezimmer, Pendeln, wandleuchte und tracks, siehe Seite 12-14, 46-47, 110, 118, 126-128



	Skærm i glas Shade glass Schirm Glas	Finish Finish Finish	Transformer Transformer Transformer	Dæmper Dimmer Dimmer	Varenr. Item no. Warennr.	EAN-nr. EAN-no. EAN-nr.
	Sort Black Schwarz	Krom Chrome Chrom	60 VA stik 60 VA plug-in 60 VA Stecker	– – –	14077170105	 5 705614 100850
	Hvid White Weiss	Krom Chrome Chrom	60 VA stik 60 VA plug-in 60 VA Stecker	– – –	14077170120	 5 705614 100867
	Sort / orange Black / orange Schwarz / orange	Krom Chrome Chrom	60 VA stik 60 VA plug-in 60 VA Stecker	– – –	14077170130	 5 705614 102175
	Sort / lime Black / lime Schwarz / limette	Krom Chrome Chrom	60 VA stik 60 VA plug-in 60 VA Stecker	– – –	14077170153	 5 705614 102182



Lup i



Lyon gulv

Floor / Boden

Højde (cm) / Height (cm) / Höhe (cm)	144
Diameter (cm) / Diameter (cm) / Durchmesser (cm)	48
Volt / Voltage / Volt	230V
Antal lyskilder / Number of bulbs / Anzahl Birnen	1
Lyskilde / Light source / Licht	60W E27
Alt. lyskilde / Alt. Light source / Alternativ Licht	11-13W E27 CFL
Ledning / Cable / Kabel	2 m
Kollistr: / Number per package / Stück pro VE	2

- Hvid PVC ledning med afbryder / White PVC cable with switch / Weiße Kunststoffkabel mit Schalter
- Lampen leveres ekskl. lyskilde / Bulb not included / Exklusiv Birne
- Lampefoden er fremstillet i polyresin / Base made of polyresin / Fuß aus Polyresin



	Skærm i tekstil Shade textile Schirm Textil	Finish Finish Finish	Transformer Transformer Transformer	Dæmper Dimmer Dimmer	Varenr: Item no. Warennr.	EAN-nr: EAN-no. EAN-nr.
	Hvid White Weiß	Hvid White Weiß	– – –	– – –	YZ02338W-1	 5 705614 109730

Lyon bordlampe, se side 78

Lyon tablelamp, see page 78

Lyon Tischleuchte, siehe Seite 78



Nice gulv

Floor / Boden

Højde (cm) / Height (cm) / Höhe (cm)	138
Diameter (cm) / Diameter (cm) / Durchmesser (cm)	48
Volt / Voltage / Volt	230V
Antal lyskilder / Number of bulbs / Anzahl Birnen	1
Lyskilde / Light source / Licht	60W E27
Alt. lyskilde / Alt. Light source / Alternativ Licht	11-13W E27 CFL
Ledning / Cable / Kabel	2 m
Kollistr. / Number per package / Stück pro VE	2

- Hvid PVC ledning med afbryder / White PVC cable with switch / Weiße Kunststoffkabel mit Schalter
- Lampen leveres ekskl. lyskilde / Bulb not included / Exklusiv Birne
- Lampefoden er fremstillet i polyresin / Base made of polyresin / Fuß aus Polyresin



	Skærm i tekstil Shade textile Schirm Textil	Finish Finish Finish	Transformer Transformer Transformer	Dæmper Dimmer Dimmer	Varenr: Item no. Warennr.	EAN-nr: EAN-no. EAN-nr.
	Hvid White Weiß		– – –	– – –	YZ02790W-1	 5 705614 109723

Nice bordlampe, se side 79
Nice tablelamp, see page 79
Nice Tischleuchte, siehe Seite 79

Neptun gulv

Floor / Boden

Højde (cm) / Height (cm) / Höhe (cm)	155
Bredde (cm) / Width (cm) / Breite (cm)	18
Antal lyskilder / Number of bulbs / Anzahl Birnen	2
Lyskilde / Light source / Licht	2,5W LED
Kollistr: / Number per package / Stück pro VE	2







- Grå PVC ledning med plug in LED driver på Neptun hvid / White PVC cable with plug in LED driver on Neptun white / Weißes Kunststoffkabel in mit LED Stecker auf Neptun weiß
- Sort PVC ledning med plug in LED driver på Neptun sort, lime, rød og lilla / Black PVC cable with plug in LED driver on Neptun black, lime, red and purple / Schwarzes Kunststoffkabel in mit LED Stecker auf Neptun schwarz, lime, rot und purpur
- Med afbryder på ledningen / With switch on the cable / Mit Schalter auf das Kabel

Neptun bord- og væglampe, se side 52, 84

Neptun table- and walllamp, see page 52, 84

Neptun Tisch- und Wandleuchte, siehe Seite 52, 84



	Skærm Shade Schirm	Finish Finish Finish	Transformer Transformer Transformer	Dæmper Dimmer Dimmer	Varenr: Item no. Warennr.	EAN-nr: EAN-no. EAN-nr.
	Sort Black Schwarz	Sort Black Schwarz	LED driver	— — —	14012020505	 5 705614 104308
	Hvid White Weiß	Hvid White Weiß	LED driver	— — —	14012022020	 5 705614 104339
	Lime Lime Limette	Lime Lime Limette	LED driver	— — —	14012025353	 5 705614 106425
	Rød Red Rot	Rød Red Rot	LED driver	— — —	14012023434	 5 705614 106432
	Lilla Purple Purpur	Lilla Purple Purpur	LED driver	— — —	14012025454	 5 705614 106449

Spirit gulv

Floor / Boden

Højde (cm) / Height (cm) / Höhe (cm)	132
Bredde (cm) / Width (cm) / Breite (cm)	68
Volt / Voltage / Volt	230V~12V
Antal lyskilder / Number of bulbs / Anzahl Birnen	1
Lyskilde / Light source / Licht	50W Gy6,35
Ledning / Cable / Kabel	2 m
Kollistr.: / Number per package / Stück pro VE	1

- Sort PVC ledning med afbryder / Black PVC cable with switch / Schwarzes Kunststoffkabel mit Schalter
- Justerbar arm / Adjustable arm / Einstellbar Arm

Spirit pendel, bord- og væglampe, se side 24, 58, 86

Spirit pendant, table- and walllamp, see page 24, 58, 86

Spirit Pendel, Tisch- und Wandleuchte, siehe Seite 24, 58, 86



	Skærm Shade Schirm	Finish Finish Finish	Transformer Transformer Transformer	Dæmper Dimmer Dimmer	Varen: Item no. Warennr.	EAN-nr: EAN-no. EAN-nr.
	Hvid metal White metal Weiß Metall	Krom Chrome Chrom	60 VA 60 VA 60 VA	Skyde Sliding Verschiebbar	14022010120	 5 705614 109587
	Sort metal Black metal Schwarz Metall	Krom Chrome Chrom	60 VA 60 VA 60 VA	Skyde Sliding Verschiebbar	14022010105	 5 705614 109570

Straight gulv

Floor / Boden

Højde (cm) / Height (cm) / Höhe (cm)	140
Diameter (cm) / Diameter (cm) / Durchmesser (cm)	9
Volt / Voltage / Volt	230V
Antal lyskilder / Number of bulbs / Anzahl Birnen	1
Lyskilde / Light source / Licht	15W R63 E27
Ledning / Cable / Kabel	2 m
Kollistr: / Number per package / Stück pro VE	2



- Hvid PVC ledning på Straight hvid / White PVC cable on Straight white / Weiß Kunststoff Kabel auf Straight weiß
- Sort PVC ledning på Straight sort, sølv og lime / Black PVC cable on Straight black, silver and lime / Schwarz Kunststoff Kabel auf Straight schwarz, silber und lime
- Lampen leveres ekskl. lyskilde / Bulb not included / Exklusiv Birne
- Med afbryder på skærm / With switch on the shade / Mit Schalter auf das Schirm



Afbryder / Switch / Schalter



Straight bord- og væglampe, se side 59, 87
 Straight table- and walllamp, see page 59, 87
 Straight Tisch- und Wandleuchte, siehe Seite 59, 87

	Skærm Shade Schirm	Finish Finish Finish	Transformer Transformer Transformer	Dæmper Dimmer Dimmer	Varenr. Item no. Warennr.	EAN-nr. EAN-no. EAN-nr.
	Sort metal Black metal Schwarz Metall	Sort Black Schwarz	– – –	– – –	14019270105	 5 705614 107118
	Sølvgrå metal Silver metal Silber Metall	Sølvgrå Silver Silber	– – –	– – –	14019270106	 5 705614 107880
	Hvid metal White metal Weiss Metall	Hvid White Weiss	– – –	– – –	14019270120	 5 705614 107125
	Lime metal Lime metal Limette Metall	Lime Lime Limette	– – –	– – –	14019270153	 5 705614 107132

Swing gulv

Floor / Boden

Højde (cm) / Height (cm) / Höhe (cm)	130
Bredde (cm) / Width (cm) / Breite (cm)	9,5
Længde (cm) / Length (cm) / Lenge (cm)	9,5
Volt / Voltage / Volt	230V~12V
Antal lyskilder / Number of bulbs / Anzahl Birnen	1
Lyskilde / Light source / Licht	50W Gy6,35
Ledning / Cable / Kabel	2 m
Kollistr. / Number per package / Stück pro VE	2

- Justerbar i højden / adjustable height / einstellbar Höhe
- Justerbar arm / Adjustable arm / Einstellbar Arm
- Sort PVC ledning / Black PVC cable / Schwarzes Kunststoffkabel

Swing væglampe, se side 60

Swing walllamp, see page 60

Swing Wandleuchte, siehe Seite 60



	Skærm Shade Schirm	Finish Finish Finish	Transformer Transformer Transformer	Dæmper Dimmer Dimmer	Varenr: Item no. Warennr.	EAN-nr: EAN-no. EAN-nr.
	Hvid glas White glass Weiß Glas	Titanium Titanium Titanium	20-60 VA 20-60 VA 20-60 VA	Skyde Sliding Verschiebbar	140730007205	 5 705614 089377

Swing Kelby gulv

Floor / Boden

Højde (cm) / Height (cm) / Höhe (cm)	130
Volt / Voltage / Volt	230V~12V
Antal lyskilder / Number of bulbs / Anzahl Birnen	1
Lyskilde / Light source / Licht	50W Gy6,35
Ledning / Cable / Kabel	2 m
Kollistr: / Number per package / Stück pro VE	2

- Justerbar i højden / adjustable height / einstellbar Höhe
- Justerbar arm / Adjustable arm / Einstellbar Arm
- Sort PVC ledning / Black PVC cable / Schwarzes Kunststoffkabel

Kelby bad, pendler og væglampe samt skinner, se side

12-14, 46-47, 110, 118, 126-128



Kelby bathroom, pendants, walllamps and tracks, see page

12-14, 46-47, 110, 118, 126-128

Kelby badezimmer, Pendeln, wandleuchte und tracks, siehe Seite

12-14, 46-47, 110, 118, 126-128



	Skærm Shade Schirm	Finish Finish Finish	Transformer Transformer Transformer	Dæmper Dimmer Dimmer	Varenr: Item no. Warennr.	EAN-nr: EAN-no. EAN-nr.
	Hvid glas White glass Weiß Glas	Sort Black Schwarz	20-60 VA 20-60 VA 20-60 VA	Skyde Sliding Verschiebbar	140511705205	 5 705614 100515

Swing KeLby



Swing Dove gulv

Floor / Boden

Højde (cm) / Height (cm) / Höhe (cm)	130
Diameter (cm) / Diameter (cm) / Durchmesser (cm)	10
Volt / Voltage / Volt	230V~12V
Antal lyskilder / Number of bulbs / Anzahl Birnen	1
Lyskilde / Light source / Licht	50W Gy6,35
Ledning / Cable / Kabel	2 m
Kollistr: / Number per package / Stück pro VE	2

- Justerbar i højden / adjustable height / einstellbar Höhe
- Justerbar arm / Adjustable arm / Einstellbar Arm
- Sort PVC ledning / Black PVC cable / Schwarzes Kunststoffkabel



	Skærm Shade Schirm	Finish Finish Finish	Transformer Transformer Transformer	Dæmper Dimmer Dimmer	Varenr: Item no. Warennr.	EAN-nr: EAN-no. EAN-nr.
	Hvid glas White glass Weiß Glas	Titanium Titanium Titanium	20-60 VA 20-60 VA 20-60 VA	Skyde Sliding Verschiebbar	14051001720S	 5 705614 089360
	Sort glas Black glass Schwarz Glas	Titanium Titanium Titanium	20-60 VA 20-60 VA 20-60 VA	Skyde Sliding Verschiebbar	14051000185S	 5 705614 093565

Vienda gulv











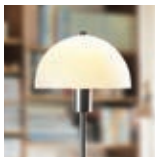

Floor / Boden

Højde (cm) / Height (cm) / Höhe (cm)	120
Diameter (cm) / Diameter (cm) / Durchmesser (cm)	19,5
Volt / Voltage / Volt	230V
Lyskilde / Light source / Licht	1 X 40W E14
Alt. lyskilde / Alt. Light source / Alternativ Licht	1 X 7-9W E14 CFL
Ledning / Cable / Kabel	2 m
Kollistr. / Number per package / Stück pro VE	4

- Hvid PVC ledning på Vienda hvid og hvid glas / White PVC cable on Vienda white and white glass / Weißes Kunststoffkabel auf Vienda weiß und weiß Glas
- Sort PVC ledning på Vienda sort, lime, rød og lilla / Black PVC cable on Vienda black, lime, red and purple / Schwarzes Kunststoffkabel auf Vienda schwarz, lime, rot und purpur
- Lampen leveres ekskl. lyskilde / Bulb not included / Exklusiv Birne

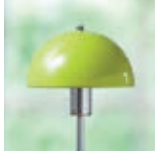

Vienda pendel og bordlampe, se side 25, 88
Vienda pendant and table lamp, see page 25, 88
Vienda Pendeln und Tischleuchte, siehe Seite 25, 88

	Skærm Shade Schirm	Finish Finish Finish	Transformer Transformer Transformer	Dæmper Dimmer Dimmer	Varenr. Item no. Warennr.	EAN-nr. EAN-no. EAN-nr.
	Hvid glas White glass Weiss Glas	Krom Chrome Chrom	– – –	– – –	14071140106	 5 705614 090038
	Sort metal Black metal Schwarz Metall	Sort Black Schwarz	– – –	– – –	14071140105	 5 705614 105169
	Hvid metal White metal Weiss Metall	Hvid White Weiss	– – –	– – –	14071140120	 5 705614 105152
	Rød metal Red metal Rot Metall	Rød Red Rot	– – –	– – –	14071140134	 5 705614 105886
	Lime metal Lime metal Limette Metall	Lime Lime Limette	– – –	– – –	14071140153	 5 705614 105862
	Lilla metal Purple metal Purpur Metall	Lilla Purple Purpur	– – –	– – –	14071140154	 5 705614 105879

Zenta gulv



Floor / Boden

Højde (cm) / Height (cm) / Höhe (cm)	135
Diameter (cm) / Diameter (cm) / Durchmesser (cm)	20
Volt / Voltage / Volt	230V
Antal lyskilder / Number of bulbs / Anzahl Birnen	3
Lyskilde / Light source / Licht	40W E14
Alt. lyskilde / Alt. Light source / Alternativ Licht	7-9W E14 CFL
Ledning / Cable / Kabel	2 m
Kollistr. / Number per package / Stück pro VE	2

- Lampen leveres eksl. lyskilde / Bulb not included / Exklusiv Birne
- PVC ledning med afbryder / PCV cable with switch / Kunststoff Kabel mit Schalter
- Sort PVC ledning med afbryder / Black PVC cable with switch / Schwarzes Kunststoffkabel mit Schalter

Zenta bordlampe, se side 80
 Zenta table lamp, see page 80
 Zenta Tischleuchte, siehe Seite 80



	Skærm Shade Schirm	Finish Finish Finish	Transformer Transformer Transformer	Dæmper Dimmer Dimmer	Varenr. Item no. Warennr.	EAN-nr. EAN-no. EAN-nr.
	Hvid glas White glass Weiß Glas	Krom Chrome Chrom			14075140120	 5705614095118

A 3D rendered scene featuring a glowing yellow capsule on a stand and a translucent blue skeleton against a metallic wall. The capsule is on the left, and the skeleton is on the right. The word "Zenta" is overlaid in the center.

Zenta

TRACKS

TRACKS

TRACKS

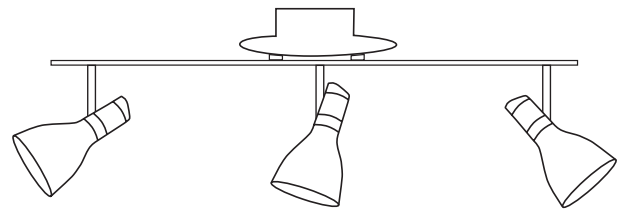





Kelby trio skinne

Trio track / Trio Schiene

Højde (cm) / Height (cm) / Höhe (cm)	21,5
Længde (cm) / Length (cm) / Länge (cm)	100
Diameter (cm) / Diameter (cm) / Durchmesser (cm)	10
Volt / Voltage / Volt	230V~12V
Antal lyskilder / Number of bulbs / Anzahl Birnen	3
Lyskilde / Light source / Licht	35W Gy6,35
Kollistr. / Number per package / Stück pro VE	4



Kelby gulv, spot og bad variant, se side 46-47, 102, 110, 126-128
 Kelby floor, spot and bathroom lamps, see page 46-47, 102, 110, 126-128
 Kelby Boden- Strahler und Baderaumleuchten, siehe Seite 46-47, 102, 110, 126-128

	Skærm Shade Schirm	Finish Finish Finish	Transformer Transformer Transformer	Dæmper Dimmer Dimmer	Varenr. Item no. Warennr.	EAN-nr. EAN-no. EAN-nr.
	Hvid glas White glass Weiß Glas	Krom Chrome Chrom	110VA elect.	- - -	18131231320	 5 705614 101314
	Sort glas Black glass Schwarz Glas	Krom Chrome Chrom	110VA elect.	- - -	18131231305	 5 705614 101307

NYHED!
NEW!
NEUHEIT!

Metro track trio / four

Trio track / Trio Schiene / Four track / Four Schiene

Længde (cm) / Length (cm) / Lenge (cm)	77
Diameter (cm) / Diameter (cm) / Durchmesser (cm)	9
Volt / Voltage / Volt	230V~12V
Antal lyskilder / Number of bulbs / Anzahl Birnen	3
Lyskilde / Light source / Licht	8W CFL E14
Kollistr. / Number per package / Stück pro VE	6



Metro væglampe, se side 48-49
Metro wall lamp, see page 48-49
Metro Wandleuchte, siehe Seite 48-49

	Skærm Shade Schirm	Finish Finish Finish	Transformer Transformer Transformer	Dæmper Dimmer Dimmer	Varenr. Item no. Warennr.	EAN-nr. EAN-no. EAN-nr.
Metro track trio 	Sort metal Black metal Schwarz Metall	Krom Chrome Chrom	— — —	— — —	18020030105	 5 705614 107262
Metro track trio 	Sølvgrå metal Silver metal Silber Metall	Krom Chrome Chrom	— — —	— — —	18020030106	 5 705614 107255
Metro track trio 	Hvid metal White metal Weiß Metall	Krom Chrome Chrom	— — —	— — —	18020030120	 5 705614 107248
Metro track four 	Sort metal Black metal Schwarz Metall	Krom Chrome Chrom	— — —	— — —	18020040105	 5 705614 107279
Metro track four 	Sølvgrå metal Silver metal Silber Metall	Krom Chrome Chrom	— — —	— — —	18020040106	 5 705614 107286
Metro track four 	Hvid metal White metal Weiß Metall	Krom Chrome Chrom	— — —	— — —	18020040120	 5 705614 107293

Track line Cut

Cut / Cut

Længde (cm) / Length (cm) / Lenge (cm)	95
Diameter (cm) / Diameter (cm) / Durchmesser (cm)	10,5
Volt / Voltage / Volt	230V
Antal lyskilder / Number of bulbs / Anzahl Birnen	3
Lyskilde / Light source / Licht	40W G9
Kollistr: / Number per package / Stück pro VE	6



Cut væg- og gulvlampe, se side 36-37, 90
 Cut wall- and floor lamp, see page 36-37, 90
 Cut Wand- und Bodenleuchte, siehe Seite 36-37, 90

	Skærm Shade Schirm	Finish Finish Finish	Transformer Transformer Transformer	Dæmper Dimmer Dimmer	Varenr. Item no. Warennr.	EAN-nr. EAN-no. EAN-nr.
	Hvid glas White glass Weiß Glas	Metalgrå Metal grey Metall grau	– – –	– – –	18113721320	 5 705614 080787
	Contrast glas Contrast glass Contrast Glas	Metalgrå Metal grey Metall grau	– – –	– – –	18113721388	 5 705614 095385

Track line Dive

Dive / Dive





Højde (cm) / Height (cm) / Höhe (cm)	14
Længde (cm) / Length (cm) / Lenge (cm)	116
Diameter (cm) / Diameter (cm) / Durchmesser (cm)	15
Volt / Voltage / Volt	230V
Antal lyskilder / Number of bulbs / Anzahl Birnen	3
Lyskilde / Light source / Licht	40W E14
Alt. lyskilde / Alt. Light source / Alternativ Licht	7-9W E14 CFL
Kollistr. / Number per package / Stück pro VE	2

- Med midterbaldakin / with centre canopy / mit Mittelbaldachin

Dive pendel og væglampe, se side 7, 40-41

Dive pendant and wall lamp, see page 7, 40-41

Dive Pendel und Wandleuchte, siehe Seite 7, 40-41

	Skærm i glas Shade glass Schirm Glas	Finish Finish Finish	Transformer Transformer Transformer	Dæmper Dimmer Dimmer	Varenr. Item no. Warennr.	EAN-nr. EAN-no. EAN-nr.
	Klar & frosted Clear & frosted Klar & frostet	Sort Black Schwarz	– – –	– – –	18113930539	 5 705614 099413

Track line Wic

Wic / Wic

Længde (cm) / Length (cm) / Lenge (cm)	80
Diameter (cm) / Diameter (cm) / Durchmesser (cm)	8
Volt / Voltage / Volt	230V
Antal lyskilder / Number of bulbs / Anzahl Birnen	3
Lyskilde / Light source / Licht	40W G9
Kollistr: / Number per package / Stück pro VE	6





- Med midterbaldakin / with centre canopy / mit Mittelbaldachin

Wic væglamper, se side 63-64

Wic wall lamps, see page 63-64

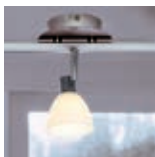
Wic Wandleuchten, siehe Seite 63-64

	Skærm Shade Schirm	Finish Finish Finish	Transformer Transformer Transformer	Dæmper Dimmer Dimmer	Varenr. Item no. Warennr.	EAN-nr. EAN-no. EAN-nr.
	Hvid glas White glass Weiß Glas	Metalgrå Metal grey Metall grau	– – –	– – –	181 1378 1820	 5 705614 100973

BADLAMPER

BATHROOM LAMPS

BADEZIMMER LEUCHTEN

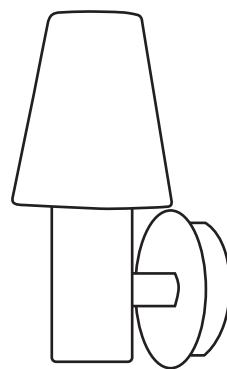



Circular badeværelseslampe IP44

Bathroom lamp IP44 / Badezimmerlampe IP44

Højde (cm) / Height (cm) / Höhe (cm)	10
Diameter (cm) / Diameter (cm) / Durchmesser (cm)	21
Volt / Voltage / Volt	230V
Antal lyskilder / Number of bulbs / Anzahl Birnen	1
Lyskilde / Light source / Licht	40W E14
Alt. lyskilde / Alt. light source / Alternativ Licht	7-9W E14 CFL
Kollistr. / Number per package / Stück pro VE	6

- Lampen leveres ekskl. lyskilde / Bulb not included / Exclusiv Birne





	Skærm Shade Schirm	Finish Finish Finish	Transformer Transformer Transformer	Dæmper Dimmer Dimmer	Varenr: Item no. Warennr.	EAN-nr: EAN-no. EAN-nr.
	Frosted glas Frosted glass Frostet Glas	Krom Chrome Chrom	– – –	– – –	03083151225	 5 705614 097013

Jupiter væglampe IP44

Wall lamp IP44 / Wandleuchte IP44

Højde (cm) / Height (cm) / Höhe (cm)	35,5
Bredde (cm) / Width (cm) / Breite (cm)	18
Længde (cm) / Length (cm) / Länge (cm)	25
Volt / Voltage / Volt	230V
Antal lyskilder / Number of bulbs / Anzahl Birnen	1
Lyskilde / Light source / Licht	40W G9
Kollistr. / Number per package / Stück pro VE	8



	Skærm Shade Schirm	Finish Finish Finish	Transformer Transformer Transformer	Dæmper Dimmer Dimmer	Varenr: Item no. Warennr.	EAN-nr: EAN-no. EAN-nr.
	Hvid stof White textile Weiß Textil	Krom Chrome Chrom	– – –	– – –	03083240120	 5 705614 107606

Kelby væglampe IP21

Wall IP21 / Wand IP21





Højde (cm) / Height (cm) / Höhe (cm)	15
Bredde (cm) / Width (cm) / Breite (cm)	12,5
Dybde (cm) / Depth (cm) / Tiefe (cm)	16,3
Volt / Voltage / Volt	230V~12V
Antal lyskilder / Number of bulbs / Anzahl Birnen	1
Lyskilde / Light source / Licht	35W Gy6,35
Kollistr. / Number per package / Stück pro VE	6

Kelby pendel, gulv- og væglampe, se side 12-14, 46-47, 102-110, 118

Kelby pendant, floor and wall lamp, see page 12-14, 46-47, 102-110, 118

Kelby Pendel, Boden- und Wandleuchten, siehe Seite 12-14, 46-47, 102-110, 118



	Skærm Shade Schirm	Finish Finish Finish	Transformer Transformer Transformer	Dæmper Dimmer Dimmer	Varenr: Item no. Warennr.	EAN-nr: EAN-no. EAN-nr.
	Hvid glas White glass Weiß Glas	Krom Chrome Chrom	Indbygget Build in Einbau	På konsol on console An Konsole	03017120120	 5 705614 102717
	Sort glas Black glass Schwarz Glas	Krom Chrome Chrom	Indbygget Build in Einbau	På konsol on console An Konsole	03017120105	 5 705614 102700

Kelby Duo væglampe IP21

Wall IP21 / Wand IP21





Højde (cm) / Height (cm) / Höhe (cm)	13
Bredde (cm) / Width (cm) / Breite (cm)	50
Dybde (cm) / Depth (cm) / Tiefe (cm)	16,3
Volt / Voltage / Volt	230V~12V
Antal lyskilder / Number of bulbs / Anzahl Birnen	2
Lyskilde / Light source / Licht	35W Gy6,35
Kollistr. / Number per package / Stück pro VE	6

Kelby pendel, gulv- og væglampe, se side 12-14, 46-47, 102-110, 118

Kelby pendant, floor and wall lamp, see page 12-14, 46-47, 102-110, 118

Kelby Pendel, Boden- und Wandleuchten, siehe Seite 12-14, 46-47, 102-110, 118



	Skærm Shade Schirm	Finish Finish Finish	Transformer Transformer Transformer	Dæmper Dimmer Dimmer	Varenr. Item no. Warennr.	EAN-nr. EAN-no. EAN-nr.
	Hvid glas White glass Weiß Glas	Krom Chrome Chrom	Indbygget Build in Einbau	På konsol on console An Konsole	03017220120	 5 705614 102731
	Sort glas Black glass Schwarz Glas	Krom Chrome Chrom	Indbygget Build in Einbau	På konsol on console An Konsole	03017220105	 5 705614 102724

Kelby Trio væglampe IP21

Wall IP21 / Wand IP21





Højde (cm) / Height (cm) / Höhe (cm)	13
Bredde (cm) / Width (cm) / Breite (cm)	80
Dybde (cm) / Depth (cm) / Tiefe (cm)	16,3
Volt / Voltage / Volt	230V~12V
Antal lyskilder / Number of bulbs / Anzahl Birnen	3
Lyskilde / Light source / Licht	35W Gy6,35
Kollistr. / Number per package / Stück pro VE	4

Kelby pendel, gulv- og væglampe, se side 12-14, 46-47, 102-110, 118

Kelby pendant, floor and wall lamp, see page 12-14, 46-47, 102-110, 118

Kelby Pendel, Boden- und Wandleuchten, siehe Seite 12-14, 46-47, 102-110, 118





	Skærm Shade Schirm	Finish Finish Finish	Transformer Transformer Transformer	Dæmper Dimmer Dimmer	Varenr: Item no. Warennr.	EAN-nr: EAN-no. EAN-nr.
	Hvid glas White glass Weiß Glas	Krom Chrome Chrom	Indbygget Build in Einbau	På konsol on console An Konsole	03017320120	 5 705614 102755
	Sort glas Black glass Schwarz Glas	Krom Chrome Chrom	Indbygget Build in Einbau	På konsol on console An Konsole	03017320105	 5 705614 102748

Mirror 500 x 700 IP44

Bathroom lamp IP44 / Badezimmerlampe IP44

Højde (cm) / Height (cm) / Höhe (cm)	70
Bredde (cm) / Width (cm) / Breite (cm)	50
Volt / Voltage / Volt	230V
Antal lyskilder / Number of bulbs / Anzahl Birnen	2
Lyskilde / Light source / Licht	T5 - 14W
Kollistr./ Number per package / Stück pro VE	1



	Skærm Shade Schirm	Finish Finish Finish	Transformer Transformer Transformer	Dæmper Dimmer Dimmer	Varenr: Item no. Warennr.	EAN-nr: EAN-no. EAN-nr.
	- - -	Grå Grey Grau	- - -	- - -	03083600025	 5 705614 102809



Venus badeværelseslampe IP44

Bathroom lamp IP44 / Badezimmerlampe IP44

Højde (cm) / Height (cm) / Höhe (cm)	26,5
Bredde (cm) / Width (cm) / Breite (cm)	12
Dybde (cm) / Depth (cm) / Tiefe (cm)	15,5
Volt / Voltage / Volt	230V
Antal lyskilder / Number of bulbs / Anzahl Birnen	1
Lyskilde / Light source / Licht	40W E14
Alt. lyskilde / Alt. Light source / Alternativ Licht	7-9W E14 CFL
Kollistr. / Number per package / Stück pro VE	8



- Med shaverudtag / With shaver plug in / Mit Rasierer Steckdosen



	Skærm Shade Schirm	Finish Finish Finish	Transformer Transformer Transformer	Dæmper Dimmer Dimmer	Varenr. Item no. Warennr.	EAN-nr. EAN-no. EAN-nr.
	Hvid glas White glass Weiß Glas	Krom Chrome Chrom	- - -	- - -	03083220120	 5 705614 107590

Zinta badeværelseslampe IP44

Bathroom lamp IP44 / Badezimmerlampe IP44

Højde (cm) / Height (cm) / Höhe (cm)	14
Bredde (cm) / Width (cm) / Breite (cm)	7
Dybde (cm) / Depth (cm) / Tiefe (cm)	14
Volt / Voltage / Volt	230V
Antal lyskilder / Number of bulbs / Anzahl Birnen	1
Lyskilde / Light source / Licht	40W G9
Kollistr. / Number per package / Stück pro VE	6



	Skærm Shade Schirm	Finish Finish Finish	Transformer Transformer Transformer	Dæmper Dimmer Dimmer	Varenr. Item no. Warennr.	EAN-nr. EAN-no. EAN-nr.
	Frosted glass Frosted glass Frostet Glas	Krom Chrome Chrom	- - -	- - -	03083091225	 5 705614 095682

UDENDØRSLAMPER
EXTERIOR
DRAUSSEN

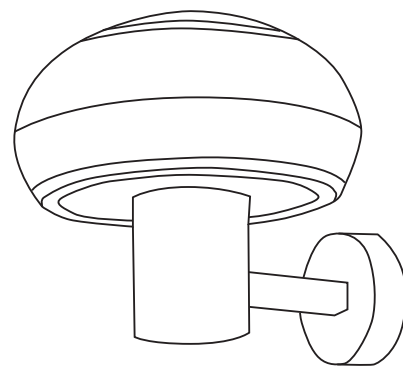

Alba - 1 væg IP44

Wall IP44/Wand IP44

Diameter (cm) / Diameter (cm) / Durchmesser (cm)	9
Volt / Voltage / Volt	230V
Antal lyskilder / Number of bulbs / Anzahl Birnen	1
Lyskilde / Light source / Licht	GX53 9W
Kollistr. / Number per package / Stück pro VE	6



- Lampen leveres ekskl. lyskilde / Bulb not included / Exklusiv Birne

	Finish Finish Finish	Materiale Material Material	Transformer Transformer Transformer	Dæmper Dimmer Dimmer	Varenr. Item no. Warennr.	EAN-nr. EAN-no. EAN-nr.
	Grå Grey Grau	Aluminium / glas Aluminium / glass Aluminium / Glas	- - -	- - -	71380	 8 421776 713802

Alba - 2 væg IP44

Wall IP44/Wand IP44

Diameter (cm) / Diameter (cm) / Durchmesser (cm)	9
Volt / Voltage / Volt	230V
Antal lyskilder / Number of bulbs / Anzahl Birnen	2
Lyskilde / Light source / Licht	GX53 9W
Kollistr. / Number per package / Stück pro VE	6



- Lampen leveres ekskl. lyskilde / Bulb not included / Exklusiv Birne

	Finish Finish Finish	Materiale Material Material	Transformer Transformer Transformer	Dæmper Dimmer Dimmer	Varenr. Item no. Warennr.	EAN-nr. EAN-no. EAN-nr.
	Grå Grey Grau	Aluminium / glas Aluminium / glass Aluminium / Glas	- - -	- - -	71381	 8 421776 713819

Amberes IP44

Wall IP44/Wand IP44

Højde (cm) / Height (cm) / Höhe (cm)	32,5
Bredde (cm) / Width (cm) / Breite (cm)	31
Dybde (cm) / Depth (cm) / Tiefe (cm)	25
Diameter (cm) / Diameter (cm) / Durchmesser (cm)	27
Volt / Voltage / Volt	230V
Antal lyskilder / Number of bulbs / Anzahl Birnen	1
Lyskilde / Light source / Licht	3U E27 11W
Kollistr. / Number per package / Stück pro VE	6



- Lampen leveres ekskl. lyskilde / Bulb not included / Exklusiv Birne

	Finish Finish Finish	Materiale Material Material	Transformer Transformer Transformer	Dæmper Dimmer Dimmer	Varenr. Item no. Warennr.	EAN-nr. EAN-no. EAN-nr.
	Grå Grey Grau	Aluminium / glas Aluminium / glass Aluminium / Glas	- - -	- - -	74280	 8 421 776 742802

Ancora væg IP44

Wall IP44/Wand IP44

Højde (cm) / Height (cm) / Höhe (cm)	11
Bredde (cm) / Width (cm) / Breite (cm)	26,4
Længde (cm) / Length (cm) / Lenge (cm)	9
Volt / Voltage / Volt	230V
Antal lyskilder / Number of bulbs / Anzahl Birnen	1
Lyskilde / Light source / Licht	E27 20W
Kollistr. / Number per package / Stück pro VE	6



- Lampen leveres ekskl. lyskilde / Bulb not included / Exklusiv Birne

	Finish Finish Finish	Materiale Material Material	Transformer Transformer Transformer	Dæmper Dimmer Dimmer	Varenr. Item no. Warennr.	EAN-nr. EAN-no. EAN-nr.
	Grå Grey Grau	Aluminium / Polycarbonat	- - -	- - -	74401	 8 421 776 744011

Boletus IP44

Wall IP44/Wand IP44

Højde (cm) / Height (cm) / Höhe (cm)	23
Bredde (cm) / Width (cm) / Breite (cm)	22,9
Længde (cm) / Length (cm) / Lenge (cm)	25
Volt / Voltage / Volt	230V
Antal lyskilder / Number of bulbs / Anzahl Birnen	1
Lyskilde / Light source / Licht	3U E27 11W
Kollistr. / Number per package / Stück pro VE	6



- Lampen leveres ekskl. lyskilde / Bulb not included / Exklusiv Birne

	Finish Finish Finish	Materiale Material Material	Transformer Transformer Transformer	Dæmper Dimmer Dimmer	Varenr. Item no. Warennr.	EAN-nr. EAN-no. EAN-nr.
	Grå Grey Grau	Aluminium / Polycarbonat	- - -	- - -	74391	 8 421 776 7439 15

Dragma væg IP65

Wall IP65/Wand IP65

Højde (cm) / Height (cm) / Höhe (cm)	10,5
Bredde (cm) / Width (cm) / Breite (cm)	9
Længde (cm) / Length (cm) / Lenge (cm)	25
Volt / Voltage / Volt	230V
Antal lyskilder / Number of bulbs / Anzahl Birnen	1
Lyskilde / Light source / Licht	G24q-2 18W
Kollistr. / Number per package / Stück pro VE	6



	Finish Finish Finish	Materiale Material Material	Transformer Transformer Transformer	Dæmper Dimmer Dimmer	Varenr. Item no. Warennr.	EAN-nr. EAN-no. EAN-nr.
	Grå Grey Grau	Aluminium / Polycarbonat	- - -	- - -	71362	 8 421 776 7136 28

Mistu bedlampe IP44

Garden lamp IP44 / Gardenleuchte IP44



Højde (cm) / Height (cm) / Höhe (cm)	60
Bredde (cm) / Width (cm) / Breite (cm)	19
Længde (cm) / Length (cm) / Lenge (cm)	19
Volt / Voltage / Volt	230V
Antal lyskilder / Number of bulbs / Anzahl Birnen	1
Lyskilde / Light source / Licht	E27 20W
Kollistr. / Number per package / Stück pro VE	2

- Lampen leveres ekskl. lyskilde / Bulb not included / Exklusiv Birne



	Finish Finish Finish	Materiale Material Material	Transformer Transformer Transformer	Dæmper Dimmer Dimmer	Varenr. Item no. Warennr.	EAN-nr. EAN-no. EAN-nr.
	Grå Grey Grau	Aluminium / Polycarbonat	- - -	- - -	74404	 8 421 776 004955

Mistu væg IP44

Wall IP44 / Wand IP44



Højde (cm) / Height (cm) / Höhe (cm)	24,5
Bredde (cm) / Width (cm) / Breite (cm)	23
Længde (cm) / Length (cm) / Lenge (cm)	19
Volt / Voltage / Volt	230V
Antal lyskilder / Number of bulbs / Anzahl Birnen	1
Lyskilde / Light source / Licht	E27 20W
Kollistr. / Number per package / Stück pro VE	4

- Lampen leveres ekskl. lyskilde / Bulb not included / Exklusiv Birne



	Finish Finish Finish	Materiale Material Material	Transformer Transformer Transformer	Dæmper Dimmer Dimmer	Varenr. Item no. Warennr.	EAN-nr. EAN-no. EAN-nr.
	Grå Grey Grau	Aluminium / Polycarbonat	- - -	- - -	74402	 8 421 776 004931

Polar væg IP44

Wall IP44/Wand IP44

Dybde (cm) / Depth (cm) / Tiefe (cm)	5,8
Diameter (cm) / Diameter (cm) / Durchmesser (cm)	14,8
Volt / Voltage / Volt	230V
Antal lyskilder / Number of bulbs / Anzahl Birnen	1
Lyskilde / Light source / Licht	GX53 9W
Kollistr. / Number per package / Stück pro VE	6



- Lampen leveres ekskl. lyskilde / Bulb not included / Exklusiv Birne

	Finish Finish Finish	Materiale Material Material	Transformer Transformer Transformer	Dæmper Dimmer Dimmer	Varenr. Item no. Warennr.	EAN-nr. EAN-no. EAN-nr.
	Grå Grey Grau	Aluminium / Polycarbonat	- - -	- - -	70680	 8 421776 005884

Proa væg IP44

Wall IP44/Wand IP44

Højde (cm) / Height (cm) / Höhe (cm)	18
Bredde (cm) / Width (cm) / Breite (cm)	11
Længde (cm) / Length (cm) / Länge (cm)	10
Volt / Voltage / Volt	230V
Antal lyskilder / Number of bulbs / Anzahl Birnen	1
Lyskilde / Light source / Licht	GU10 35W
Kollistr. / Number per package / Stück pro VE	6



- Lampen leveres ekskl. lyskilde / Bulb not included / Exklusiv Birne

	Finish Finish Finish	Materiale Material Material	Transformer Transformer Transformer	Dæmper Dimmer Dimmer	Varenr. Item no. Warennr.	EAN-nr. EAN-no. EAN-nr.
	Grå Grey Grau	Aluminium / glas Aluminium / glass Aluminium / Glas	- - -	- - -	74400	 8 421776 744004



Set plafond IP44

Plafond IP44 / Plafond IP44

Højde (cm) / Height (cm) / Höhe (cm)	17
Længde (cm) / Length (cm) / Lenge (cm)	13
Volt / Voltage / Volt	230V
Antal lyskilder / Number of bulbs / Anzahl Birnen	1
Lyskilde / Light source / Licht	GU10 9W
Kollistr. / Number per package / Stück pro VE	4



- Lampen leveres ekskl. lyskilde / Bulb not included / Exklusiv Birne



	Finish Finish Finish	Materiale Material Material	Transformer Transformer Transformer	Dæmper Dimmer Dimmer	Varenr. Item no. Warennr.	EAN-nr. EAN-no. EAN-nr.
	Grå Grey Gru	Aluminium / glas Aluminium / glass Aluminium / Glas	- - -	- - -	68102	 8 421776 681026

Sigma væg IP44

Wall IP44 / Wand IP44

Højde (cm) / Height (cm) / Höhe (cm)	21,5
Bredde (cm) / Width (cm) / Breite (cm)	11
Volt / Voltage / Volt	230V
Antal lyskilder / Number of bulbs / Anzahl Birnen	1
Lyskilde / Light source / Licht	E27 11W CFL
Kollistr. / Number per package / Stück pro VE	6



	Finish Finish Finish	Materiale Material Material	Transformer Transformer Transformer	Dæmper Dimmer Dimmer	Varenr. Item no. Warennr.	EAN-nr. EAN-no. EAN-nr.
	Grå Grey Gru	Aluminium / Polycarbonat	- - -	- - -	73250	 8 421776 732506

Sigma bedlampe IP44

Garden lamp IP44 / Gartenleuchte IP44

Højde (cm) / Height (cm) / Höhe (cm)	65
Diameter (cm) / Diameter (cm) / Durchmesser (cm)	16,8
Volt / Voltage / Volt	230V
Antal lyskilder / Number of bulbs / Anzahl Birnen	1
Lyskilde / Light source / Licht	E27 11W CFL
Kollistr: / Number per package / Stück pro VE	4



- Lampen leveres ekskl. lyskilde / Bulb not included / Exklusiv Birne

	Finish Finish Finish	Materiale Material Material	Transformer Transformer Transformer	Dæmper Dimmer Dimmer	Varenr: Item no. Warennr.	EAN-nr: EAN-no. EAN-nr.
	Grå Grey Grau	Aluminium / Polycarbonat	- - -	- - -	73253	 8 421776 732537

Forbehold/Reservation/Vorbehalt

Der tages forbehold for eventuelle trykfejl. Herstal udvikler og forbedrer løbende sit produktsortiment. Små afvigelser mellem de leverede produkter og illustrationerne i nærværende katalog kan derfor forekomme, hvorfor illustrationer og beskrivelser i dette katalog ikke skal indgå i nogen form for kontrakt. Oplysninger om eventuelle ændringer fås ved henvendelse til Herstal.

All care has been taken to ensure that illustrations and descriptions in this catalogue are correct at the time of publication. Because Herstal has a policy of constant product improvement, products supplied may differ in detail from the illustrations and description given and therefore, the descriptions and illustrations in this publication shall not form part of any contract. Details of alterations will be provided on request.

Keine Haftung für etwaige Druckfehler. Herstal entwickelt und verbessert laufend sein Produktsortiment. Es können kleine Abweichungen zwischen den gelieferten Produkten und den Abbildungen in diesem Katalog vorkommen. Daher sind Abbildungen und Beschreibungen in diesem Katalog in keiner Weise Bestandteil eines Vertrages. Auskünfte über etwaige Änderungen auf Anfrage bei Herstal.



Herstal[®]
REG. TRADE MARK