

CARPYEN

creativity concept

2006 / 2007

52

52 años diseñando luz. 8 diseñadores de vanguardia. 11 colecciones. 82 modelos y un número incontable de colaboradores. Bienvenidos al mundo de la iluminación creativa. Bienvenidos al mundo Carpyen.

8



Diseñadores



1. GABRIEL TEIXIDÓ 2. PASCUAL SALVADOR 3. JORDI MILÀ 4. JONATHAN DAIFUKU 5. TONI PALLEJÀ, PORCUATRO 6. NOVA+ 7. L'ESTUDI 8. NAHTRANG DISSENY

4

COLECCIONES /
COLLECTIONS /
KOLLEKTIONEN

PLAFONES, APLIQUES,
APLIQUES CUADROS
Y FOCOS /
CEILING, WALL AND PICTURE
LAMPS, AND SPOTLIGHTS /
DECKENLEUCHTEN,
WANDLEUCHTEN,
BILDERLEUCHTEN UND
STRAHLER

COLGANTES, SOBREMESAS,
PINZAS Y LÁMPARAS DE PIE /
SUSPENSION, TABLE,
CLIP-ON AND FLOOR
LAMPS /
PENDELLEUCHTEN,
TISCHLEUCHTEN,
KLEMMLEUCHTEN UND
STEHLEUCHTEN

LUCES DE ACEITE /
OIL LAMPS /
MINERALÖL-LEUCHTER

1

nirvana
city
naomi
tria
gala
aura
aurita
galilea
gilda
scott
harry

2

viper
phyton
square
basic
rita
jacky
kiwi
waki
mini
odyssey
boxster
top
clara
sunset
orly
hotel
zénit
área
valentina
alfa
gamma
mercury
infiniti
fritz
hans
suite
berta
marta
erik
sun
kao
ris
hamilton
betty
rondo
oval
gallery
mondrian
dial
flash
focus
focus mini

3

irma
funi
max
nick
frida
petra
tommy
finger
metropol
tema
douglas
aladina
master
japan
nairobi
pocket
pascualina
willy
hi-fi
carla
augusta
cónica
barcino
atenea
omara

4

candel
poppy



1

nirvana

GABRIEL TEIXIDÓ



NIRVANA pie / floor / stehleuchte

Pie suelo metálico con pantalla en algodón, interruptor en el mismo portalámparas.

BOMBILLAS
1x150 W máx. (E-27)

ACABADOS
Níquel mate.
Pantalla: blanca, beige y negra.

Metallic floor lamp with cotton lampshade. Switch in the lampholder.

BULBS
1x150 W max. (E-27)

FINISHES
Matt nickel.
Lampshade: white, beige and black.

Stehleuchte aus Metall mit Lampenschirm aus Baumwolle und Schnurschalter.

LAMPE
1x150 W max. (E-27)

OBERFLÄCHE
Nickel matt.
Lampenschirm: weiß, beige oder schwarz.

8

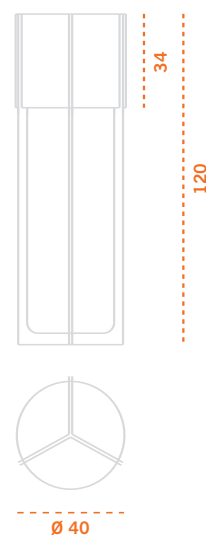



nirvana

GABRIEL TEIXIDÓ

10



Sobremesa metálico con pantalla en algodón, interruptor en el mismo portalámparas.

BOMBILLAS
1x150 W máx. (E-27)

ACABADOS
Níquel mate.
Pantalla: blanca, beige y negra.

Metallic table lamp with cotton lampshade. On-off switch in the lampholder.

BULBS (incandescent)
1x150 W max. (E-27)

FINISHES
Matt nickel.
Lampshade: white, beige and black.

Tischleuchte aus Metall mit Lampenschirm aus Baumwolle und Schnurschalter.

LAMPE
1x150 W max. (E-27)

OBERFLÄCHE
Gehäuse: nickel matt.
Lampenschirm: weiß, beige oder schwarz.



11

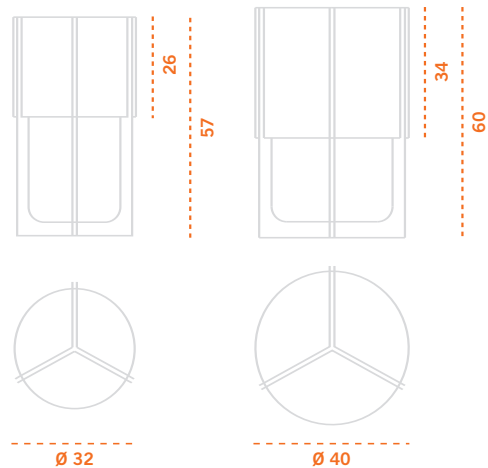

nirvana

GABRIEL TEIXIDÓ

12



Sobremesa metálico con pantalla en algodón, interruptor en el mismo portalámparas.

BOMBILLAS
1x150 W máx. (E-27)

ACABADOS
Níquel mate.
Pantalla: blanca, beige y negra.

Metallic table lamp with cotton lampshade. On-off switch in the lampholder.

BULBS (incandescent)
1x150 W max. (E-27)

FINISHES
Matt nickel.
Lampshade: white, beige and black.

Tischleuchte aus Metall mit Lampenschirm aus Baumwolle und Schnurschalter.

LAMPE
1x150 W max. (E-27)

OBERFLÄCHE
Gehäuse: nickel matt.
Lampenschirm: weiß, beige oder schwarz.



NIRVANA mini



NIRVANA pie / floor / stehleuchte



NIRVANA sobremesa / table / tischleuchte



NIRVANA sobremesa / table / tischleuchte



NIRVANA mini / mini / mini

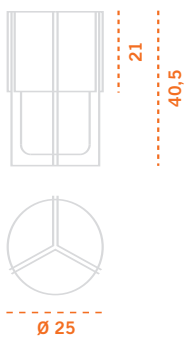

city

GABRIEL TEIXIDÓ

Pie suelo metálico. Orientable en todos los sentidos. Reflector giratorio 360°, incorpora interruptor.

BOMBILLAS
1x75 W máx. (G9) Halógena

ACABADOS
Cromo.

Metallic floor lamp rotating in all directions. The reflector rotates 360° and incorporates an on-off switch.

BULBS
1x75 W max. (G9) Halogen

FINISHES
Chrome.

Stehleuchte aus Metall. Dreh- und schwenkbar, Reflektor um 360° drehbar mit integrierterem Schalter.

LAMPE
1x75 W max. (G9) Halogen

OBERFLÄCHE
Chrom.

14

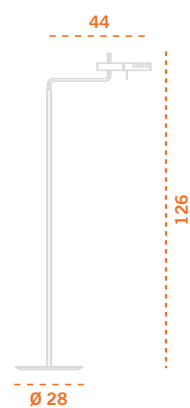
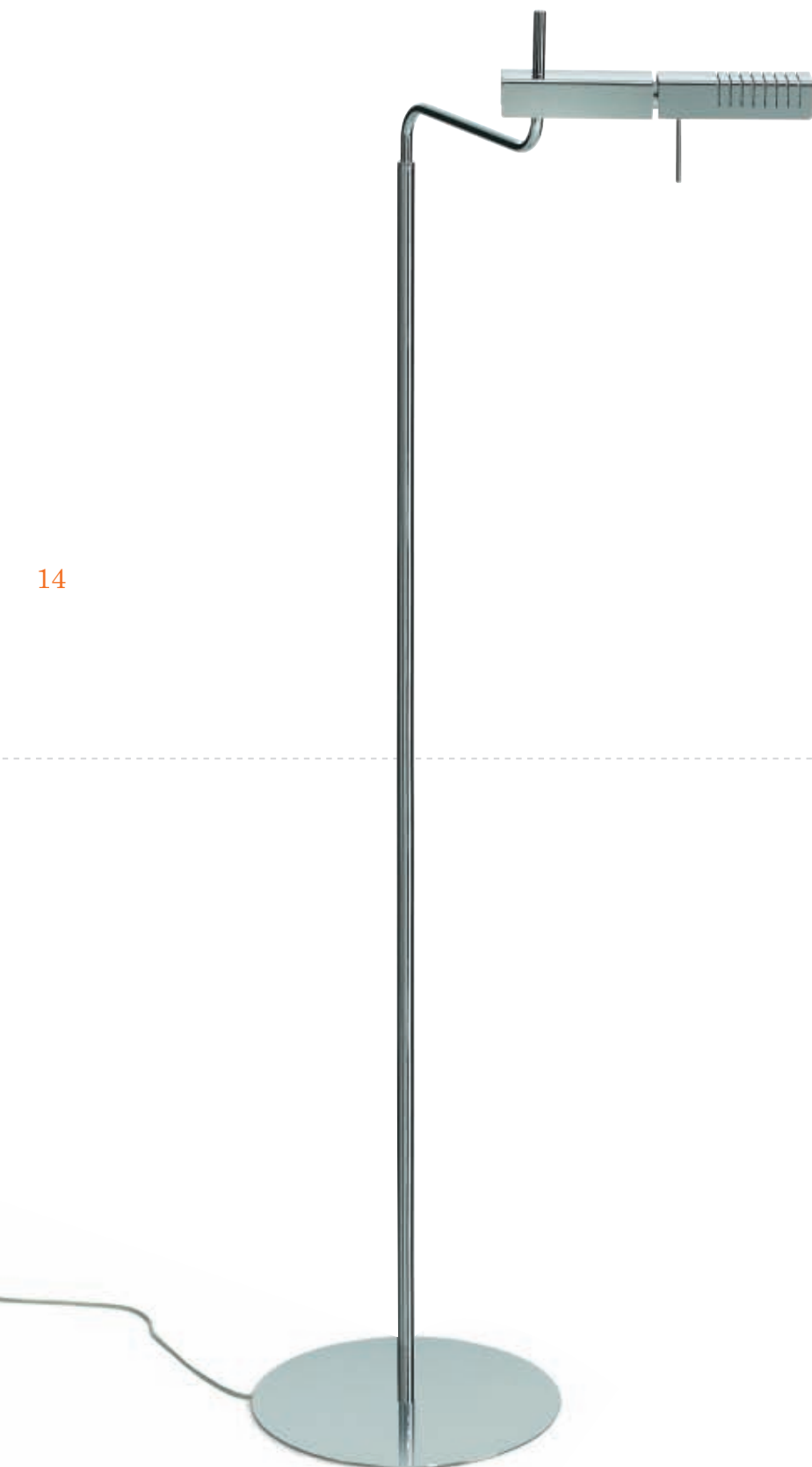



city

GABRIEL TEIXIDÓ

Lámpara metálica orientable en todos los sentidos. Reflector giratorio 360°, incorpora interruptor. Versión sobremesa.

BOMBILLAS
1x75 W máx. (G9) Halógena

ACABADOS
Cromo.

Metallic table lamp rotating in all directions. The reflector rotates 360° and incorporates an on-off switch.

BULBS
1x75 W max. (G9) Halogen

FINISHES
Chrome.

Tischleuchte aus Metall, dreh- und schwenkbar in alle Richtungen, Reflektor 360° drehbar mit intergriertem Schalter.

LAMPE
1x75 W max. (G9) Halogen

OBERFLÄCHE
Chrom.



16

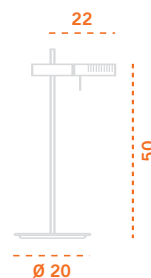



city

GABRIEL TEIXIDÓ

Lámpara metálica orientable en todos los sentidos. Reflector giratorio 360°, incorpora interruptor. Versión pinza (5 cm de apertura).

BOMBILLAS

1x75 W máx. (G9) Halógena

ACABADOS

Cromo.

Metallic table lamp with clamp (5 cm opening) rotating in all directions. The reflector rotates 360° and incorporates an on-off switch.

BULBS

1x75 W max. (G9) Halogen

FINISHES

Chrome.

Leuchte aus Metall mit Tischklemme (Klemmöffnung max. 5 cm), dreh- und schwenkbar in alle Richtungen, Reflektor um 360° drehbar mit intergriertem Schalter.

LAMPE

1x75 W max. (G9) Halogen

OBERFLÄCHE

Chrom.



18

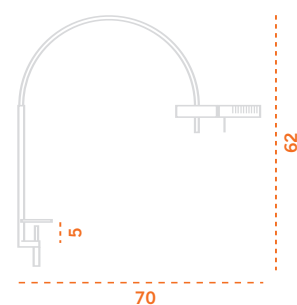



city

GABRIEL TEIXIDÓ

20



Aplique metálico orientable en todos los sentidos. Reflector giratorio 360°, incorpora interruptor.

BOMBILLAS
1x75 W máx. (G9) Halógena.

ACABADOS
Cromo.

Metallic wall lamp rotating in all directions. The reflector rotates 360° and incorporates an on-off switch.

BULBS
1x75 W max. (G9) Halogen.

FINISHES
Chrome.

Wandleuchte aus Metall. Dreh- und schwenkbar, Reflektor um 360° drehbar mit integriertem Schalter.

LAMPE
1x75 W max. (G9) Halogen.

OBERFLÄCHE
Chrom.

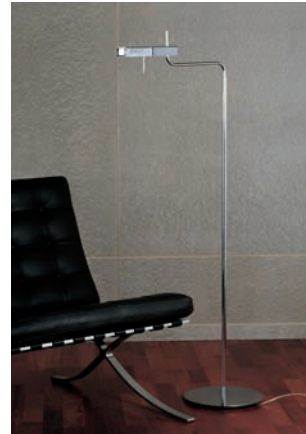
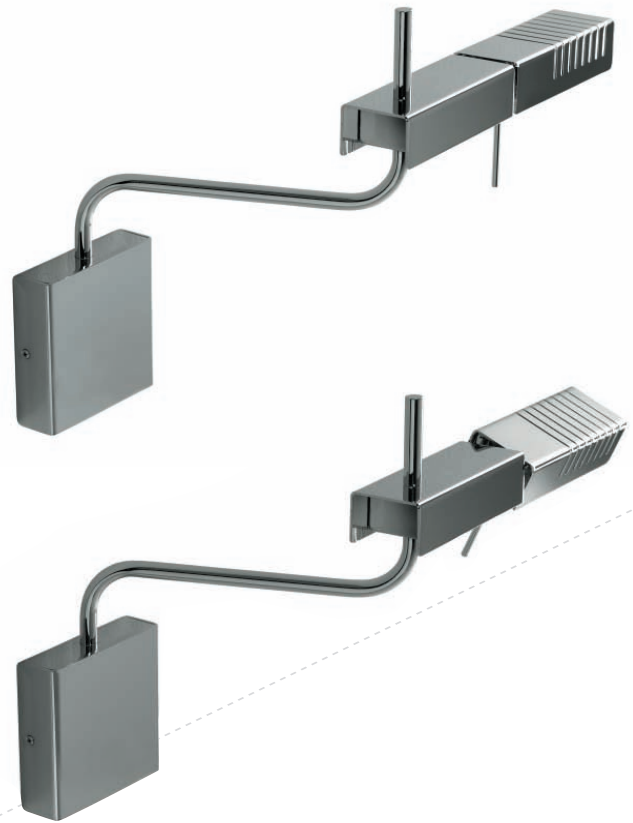

CITY pie / floor / stehleuchte



CITY sobremesa / table / tischleuchte



CITY pinza / clip-on / klemmleuchte

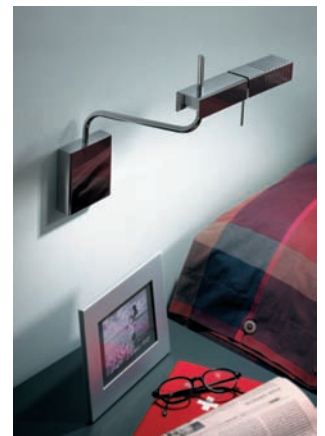

CITY aplique / wall lamp / wandleuchte

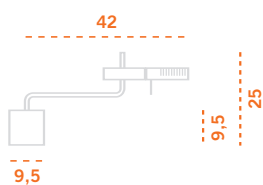

naomi

PORCUATRO



22

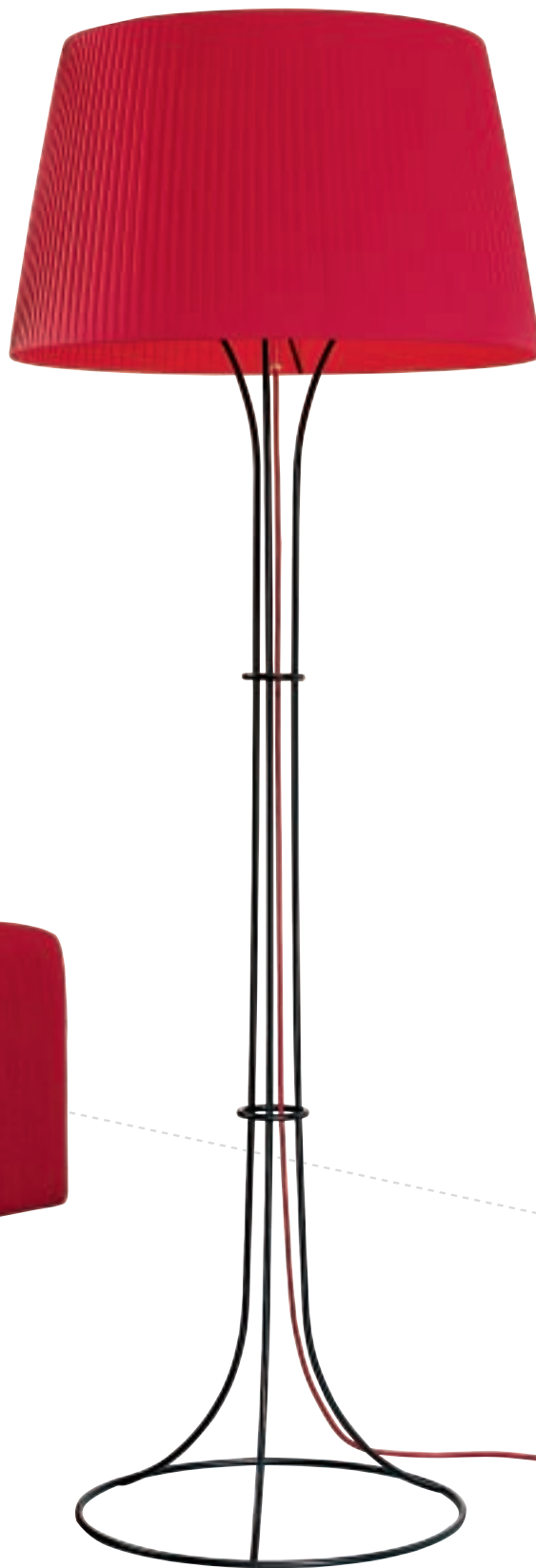
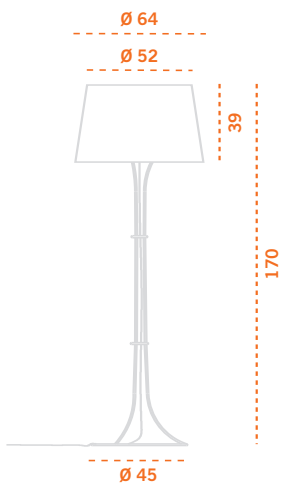

Lámpara pie suelo metálica.
Equipada con dimmer. Existe
la versión con cable negro.

BOMBILLAS
1x150 W máx. (E-27)

ACABADOS
Estructura negra.

PANTALLA
Cintas: beige, roja y negra.

Metallic floor lamp. Equipped with
dimmer. A black cable version is
also available.

BULBS
1x150 W max. (E-27)

FINISHES
Black structure.

LAMPSHADES
Bookbinding tape lampshade:
beige, red and black.

Stehleuchte aus Metall mit
integriertem Dimmer. Kabel
wahlweise rot oder schwarz.

LAMPE
1x150 W max. (E-27)

OBERFLÄCHE
Schwarz strukturiert.

LAMPENSCHIRM
Buchbindungs-Stil: beige, rot oder
schwarz.



naomi

PORCUATRO

24



Lámpara sobremesa metálica.
Equipada con dimmer. Existe la
versión con cable negro.

BOMBILLAS
1x150 W máx. (E-27)

ACABADOS
Estructura negra.

PANTALLA
Cintas: beige, roja y negra.

Metallic table lamp. Equipped with
dimmer. A black cable version is
also available.

BULBS
1x150 W max. (E-27)

FINISHES
Black structure.

LAMPSHADE
Bookbinding tape lampshade:
beige, red and black.

Tischleuchte aus Metall mit
integriertem Dimmer. Kabel
wahlweise rot oder schwarz.

LAMPE
1x150 W max. (E-27)

OBERFLÄCHE
Schwarz strukturiert.

LAMPENSCHIRM
Buchbindung-Stil: beige, rot oder
schwarz.



NAOMI pie / floor / stehleuchte



NAOMI sobremesa / table / tischleuchte

tria

GABRIEL TEIXIDÓ

Pie suelo metálico con pantalla.
Interruptor en el mismo porta-
lámparas. Se fabrica en dos
medidas. A la medida XL se le
puede incorporar dos tipos de
mesas metálicas.

BOMBILLAS
2x150 W máx. (E-27)

ACABADOS
Barra: cromo.

Mesa: metálico blanco o plomo
metalizado.

Pantallas: ecológica, blanca, beige
y negra.

Metallic floor lamp with shade.
Switch on the socket. Available in
two sizes. XL size can have two
tables.

BULBS
2x150 W max. (E-27)

FINISHES
Stem: chrome.

Table: metallic lead or metallic
white.

Shades: ecologic, white, beige and
black.

Stehleuchte aus Metall mit
Baumwollschirm und Zugschalter
an der Lampenfassung. In zwei
Größen erhältlich. Als Zubehör sind
zwei Arten Tischplatten lieferbar.

LAMPE
2x150 W max. (E-27)

OBERFLÄCHE
Gestell: chrom.

Tisch: Metall weiß oder grau-
metallic.

Schirme: natur, weiß, beige oder
schwarz.



TRIA XL:
ACCESORIOS
ACCESSORIES
ZUBEHÖR



Ø 41



Ø 60

mesas / tables / tische

TRIA XL

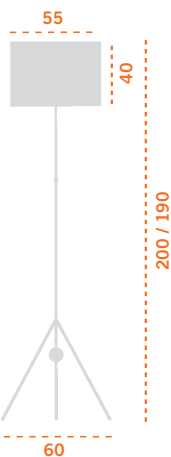

TRIA L

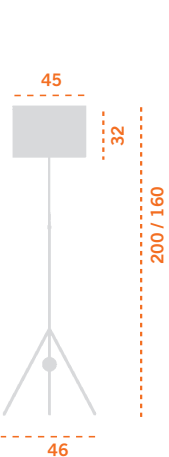



tria halógena

GABRIEL TEIXIDÓ

Pie de suelo con dimmer. Se caracteriza por su gran dimensión.

BOMBILLAS
1x500 W (R7S 118 mm).

ACABADOS
Cuerpo en cromo y reflector en blanco.

Metal, halogen, floor lamp.
Equipped with dimmer.

BULBS
1x500 W (R7S 118 mm).

FINISHES
Chrome with white reflector.

Sehr große, um 10 cm höhenverstellbare Stehleuchte. Mit Schnurdimmer ausgestattet.

LAMPE
1x500 W max. (R7S 118 mm)

OBERFLÄCHE
Chrom mit weißem Reflektor.



28

TRIA halógena / halogen / halogen





gala

GABRIEL TEIXIDÓ



Pie de suelo halógeno (equipado con dimmer) y sobremesa incandescente.

BOMBILLAS

- Pie de suelo:
1x300 W máx. (R7S 118 mm)
- Sobremesa:
1x60 W máx. (E-14)

ACABADOS

Plomo metalizado y oro metalizado.

Halogen metallic floor (with dimmer) and metallic table lamp.

BULBS

- Floor lamp:
1x300 W max. (R7S 118 mm)
- Table lamp:
1x60 W max. (E-14)

FINISHES

Metallic grey and metallic gold.

Stehleuchte mit Schnurdimmer. Auch als Tischleuchte erhältlich.

LAMPE

- Stehleuchte:
1x300 W max. (R7S 118 mm)
- Tischleuchte:
1x60 W max. (E-14)

OBERFLÄCHE

Grau- oder gold-metallic.

30

GALA MINI

GALA

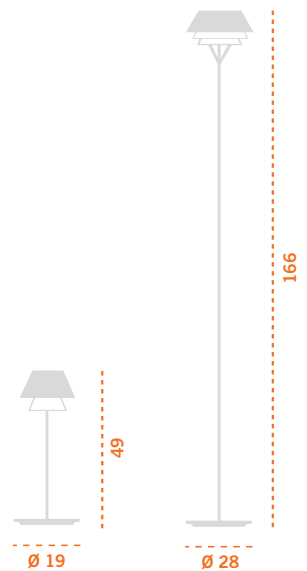





Aplique metálico.

BOMBILLAS

- Gala (pantalla triple):
1x300 W máx. (R7S 118 mm)
- Gala mini (pantalla doble):
1x60 W máx. (E-14)

ACABADOS

Plomo metalizado y oro metalizado.

Metallic wall lamp.

BULBS

- Gala (triple shade):
1x300 W máx. (R7S 118 mm)
- Gala mini (double shade):
1x60 W máx. (E-14)

FINISHES

Metallic lead and metallic gold.

Wandleuchte aus Metall.

LAMPE

- Gala (mit dreifachem Schirm):
1x300 W max. (R7S 118 mm)
- Gala mini (mit zweifachem Schirm):
1x60 W max. (E-14)

OBERFLÄCHE

Grau- oder gold-metallic.



GALA



GALA MINI

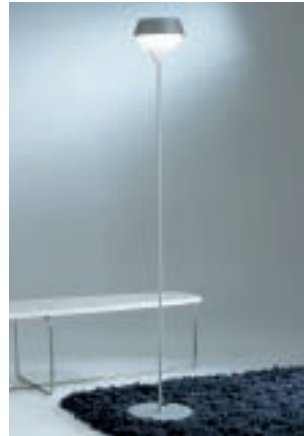
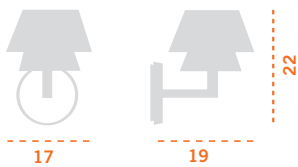

GALA pie / floor / stehleuchte

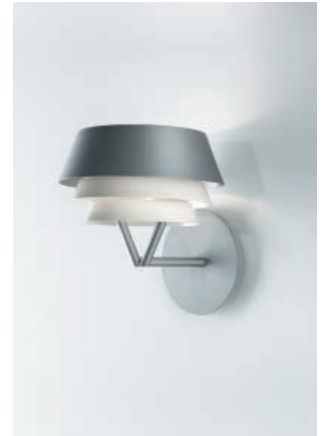

GALA aplique / wall lamp / wandleucht



GALA MINI sobremesa / table / tischleuchte



GALA MINI aplique / wall lamp / wandleuchte

aura

GABRIEL TEIXIDÓ



Colgante metálico con pantalla de tela en algodón.

BOMBILLAS
1x150 W máx. (E-27)

ACABADOS
Cromo y plomo metalizado.

PANTALLAS
- Lisa: blanca, beige y negra.
- Plisada: beige.

Pendant lamp with cotton fabric shade.

BULBS
1x150 W max. (E-27)

FINISHES
Chrome and metallic lead.

LAMPSHADES
- Flat: white, beige and black.
- Pleated: beige.

Pendeleuchte mit cotton fabric shade.

LAMPE
1x150 W max. (E-27)

OBERFLÄCHE
Chrom oder grau-metallic.

LAMPENSCHIRM
- Glatt: grau, beige oder schwarz.
- Plissiert: beige.

34

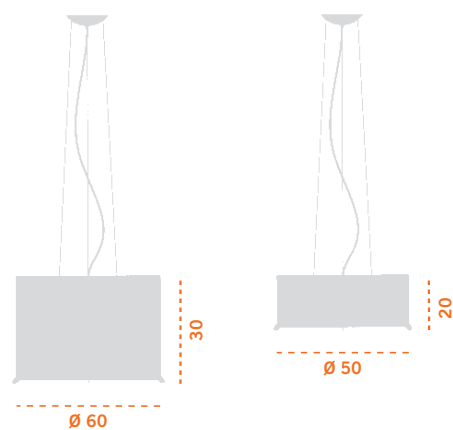



aura

GABRIEL TEIXIDÓ

36



Sobremesa y aplique metálico con pantalla de tela en algodón, interruptor en el mismo portalámparas.

BOMBILLAS

- Sobremesa: 2x100 W máx. (E-27)
- Aplique: 1x100 W máx. (E-27)

ACABADOS

Cromo y plomo metalizado.

PANTALLAS

- Lisa: blanca, beige y negra.
- Plisada: beige.



SOBREMESA
TABLE LAMP
TISCHLEUCHTE

Table and wall lamp with cotton fabric shade. Switch on the same socket.

BULBS

- Table lamp: 2x100 W max. (E-27)
- Wall lamp: 1x100 W máx. (E-27)

FINISHES

Chrome and metallic lead.

LAMPSHADES

- Flat: white, beige and black.
- Pleated: beige.

Tischleuchte aus Metall mit Schirm aus Baumwolltwill. Mit Zugschalter an der Lampenfassung.

LAMPE

2x100 W max. (E-27)

OBERFLÄCHE

Chrom oder grau-metallic.

LAMPENSCHIRM

- Glatt: grau, beige oder schwarz.
- Plissiert: beige.



APLIQUE
WALL LAMP
WANDEUCHTE

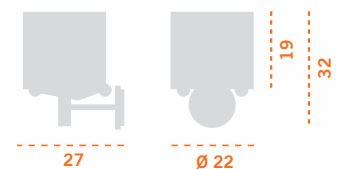
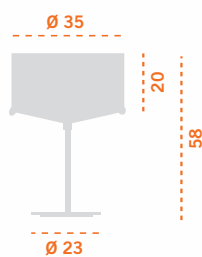

aura

GABRIEL TEIXIDÓ



38

Pie suelo metálico con pantalla de tela en algodón, interruptor en el mismo portalámparas.

BOMBILLAS
2x100 W máx. (E-27)

ACABADOS
Cromo y plomo metalizado.

PANTALLAS
- Lisa: blanca, beige y negra.
- Plisada: beige.

Metallic floor lamp with cotton fabric shade. Switch on the same socket.

BULBS
2x100 W max. (E-27)

FINISHES
Chrome and metallic lead.

LAMPSHADES
- Flat: white, beige and black.
- Pleated: beige.

Stehleuchte aus Metall mit Schirm aus Baumwolltwill. Mit Zugschalter an der Lampenfassung.

LAMPE
2x100 W max. (E-27)

OBERFLÄCHE
Chrom oder grau-metallic.

LAMPENSCHIRM
- Glatt: grau, beige oder schwarz.
- Plissiert: beige.

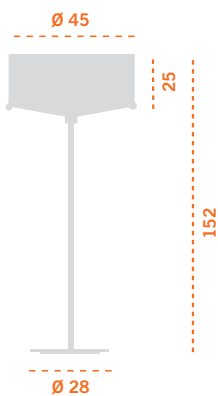

AURA colgante / suspension lamp / pendelleuchten



AURA sobremesa / table / tischleuchte



AURA applique / wall lamp / wandleuchte



AURA pie / floor / stehleuchte

aurita

GABRIEL TEIXIDÓ

Sobremesa metálico con pantalla de tela en algodón. Se fabrica en dos alturas.

BOMBILLAS
1x100 W máx. (E-27)

ACABADOS
Cromo, plomo metalizado y oro metalizado.
Pantalla lisa: blanca, beige y negra.

Metallic table lamp with cotton fabric shade. Made in two heights.

BULBS
1x100 W max. (E-27)

FINISHES
Chrome, metallic lead and metallic gold.
Flat lampshade: white, beige and black.

Tischleuchte aus Metall mit Schirm aus Baumwolle. Erhältlich in zwei Größen.

LAMPE
1x100 W max. (E-27)

OBERFLÄCHE
Chrom, grau -oder gold-metallic.
Lampenschirm glatt: grau, beige oder schwarz.

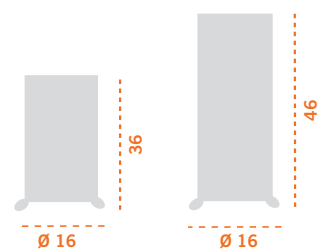



galilea

PASCUAL SALVADOR

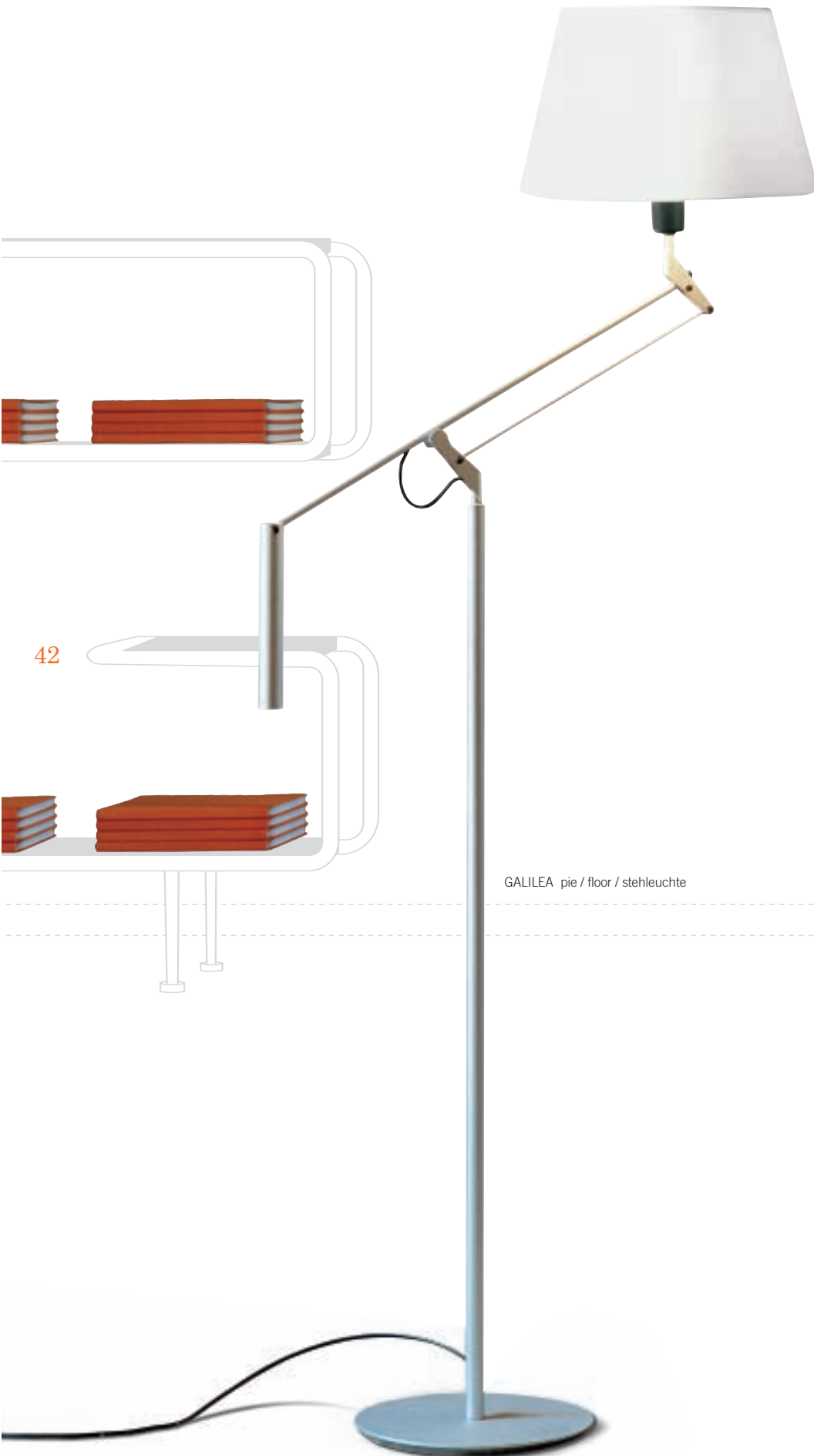

Lámpara de pie con luz directa y difusa. Se caracteriza por su brazo abatible y giratorio.

BOMBILLAS
1x100 W máx. (E-27)

ACABADOS
Titanio, plomo metalizado y oro metalizado.
Pantallas: blanco o beige en algodón.

Floor lamp with direct and diffuse light. Adjustable and movable arm.

BULBS
1x100 W max. (E-27)

FINISHES
Metallic lead, metallic gold and titanium.
Shades: cotton fabric in white or beige.

Stehleuchte aus Metall mit dreh- und schwenkbarem Arm. Auch als besonders große Stehleuchte (Maxi-Galilea) und Tischleuchte erhältlich.

LAMPE
1x100 W max. (E-27)

OBERFLÄCHE
Titan, grau-metallic oder gold-metallic.
Schirme: Baumwolle glatt weiß oder beige.



DELTA DE PLATA 1995
ADI-FAD

GALILEA pie / floor / stehleuchte

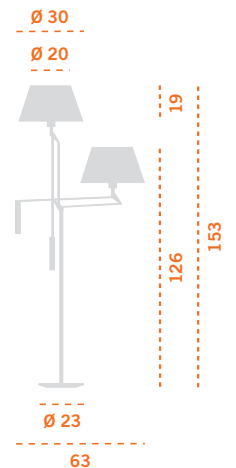



galilea

PASCUAL SALVADOR



GALILEA mini / mini / mini

Lámpara de sobremesa con luz directa y difusa. Se caracteriza por su brazo abatible y giratorio.

BOMBILLAS
1x60 W máx. (E-14)

ACABADOS
Titanio, plomo metalizado y oro metalizado.

Pantallas: blanco o beige en algodón.

Table lamp with direct and diffuse light. Adjustable and movable arm.

BULBS
1x60 W max. (E-14)

FINISHES
Metallic lead, metallic gold and titanium.

Shades: cotton fabric in white or beige.

Tischleuchte mit Baumwoll-Schirm auf dreh- und schwenkbarem Arm. Auch als größere Tischleuchte und Stehleuchte erhältlich.

LAMPE
1x60 W max. (E-14)

OBERFLÄCHE
Titan, grau-metallic oder gold-metallic.

Schirme: Baumwolle glatt weiß oder beige.

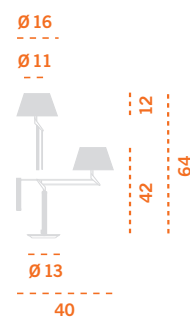





Lámpara de sobremesa con luz directa y difusa. Se caracteriza por su brazo abatible y giratorio.

BOMBILLAS

1x100 W máx. (E-27)

ACABADOS

Titanio, plomo metalizado y oro metalizado.

Pantallas: blanco o beige en algodón.

Table lamp with direct and diffuse light. Adjustable and movable arm.

BULBS

1x100 W max. (E-27)

FINISHES

Metallic lead, metallic gold and titanium.

Shades: cotton fabric in white or beige.

Tischleuchte mit Baumwoll-Schirm auf dreh- und schwenkbarem Arm. Auch als Mini-Version und Stehleuchte erhältlich.

LAMPE

1x100 W max. (E-27)

OBERFLÄCHE

Titan, grau-metallic oder gold-metallic.

Schirme: Baumwolle glatt weiß oder beige.



GALILEA sobremesa / table / tischleuchte

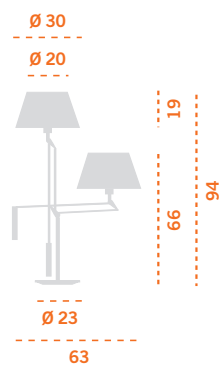

galilea
PASCUAL SALVADOR

48



Lámpara de pie con luz directa y difusa. Se caracteriza por su brazo abatible y giratorio de grandes dimensiones, pensado para espacios amplios (lofts, etc).

BOMBILLAS
1x150 W máx. (E-27)

ACABADOS
Titanio, plomo metalizado y oro metalizado.
Pantallas: blanco o beige en algodón.

Floor lamp with direct and diffuse light. Adjustable and movable arm of big dimensions. Made for wide spaces (lofts, etc).

BULBS
1x150 W max. (E-27)

FINISHES
Metallic lead, metallic gold and titanium.
Shades: cotton fabric in white or beige.

Stehleuchte aus Metall mit dreh- und schwenkbarem Arm. Auch als normal-große Stehleuchte und Tischleuchte erhältlich. In der Maxi-Version vor allem für großzügige Räume (z.B. Lofts) gedacht.

LAMPE
1x150 W max. (E-27)

OBERFLÄCHE
Titan, grau-metallic oder gold-metallic.
Schirme: Baumwolle glatt weiß oder beige.



GALILEA pie / floor / stehleuchte

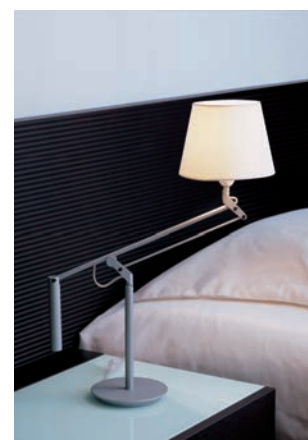

GALILEA mini / mini / mini

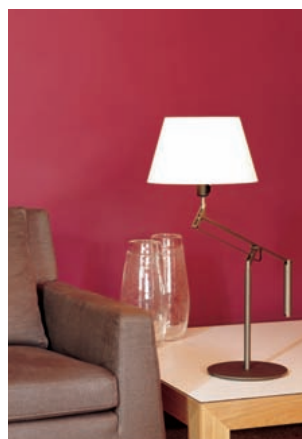
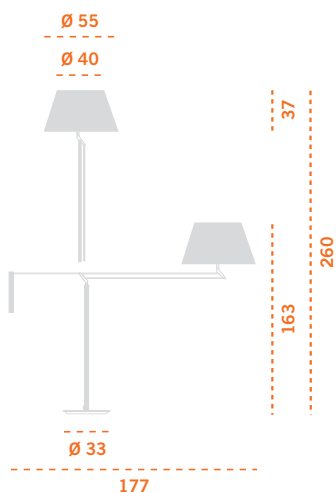

GALILEA sobremesa / table / tischleuchte



GALILEA maxi / maxi / maxi



Lámparas sobremesa y apliques metálicos, con una parte en madera.

Las lámparas de sobremesa se fabrican en tres medidas. Los apliques se fabrican en dos, versiones fijo o móvil. Los apliques móviles giran 170° e incorporan cable con interruptor que no necesita instalación en la pared.

BOMBILLAS

1x60 W máx. (E-14) pequeños.
1x100 W máx. (E-27) grandes.

ACABADOS

Plomo metalizado.
Pantallas: blanco, beige.
Madera: wengué, cerezo, haya natural.

Table and wall lamp metal frame-wood accent.

Table lamp is available in three sizes.

Wall lamp is available in two sizes and two versions. Fixed arm and candelabra base. The candelabra base rotating 170° cable with switch which doesn't need wall installation.

BULBS

1x60 W max. (E-14) small.
1x100 W max. (E-27) big.

FINISHES

Metallic lead.
Shades: white and beige.
Wood: wenge, dark cherry and beech.

Tischleuchte aus Metall Holzapplikation. In drei Größen erhältlich. Auch als Wandleuchte.

LAMPE

1x60 W max. (E-14) klein.
1x100 W max. (E-27) medium und groß.

OBERFLÄCHE

Grau-metallic.
Schirme: weiß oder beige
Hölzer: Wenge, Kirsche oder Buche.

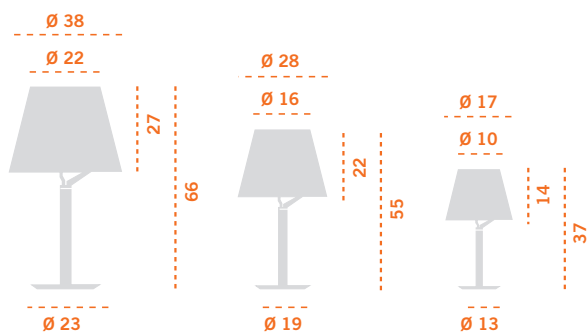

GILDA móvil / rotating / mobil



52

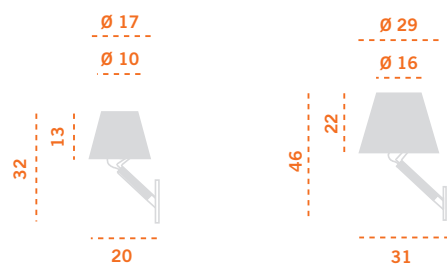
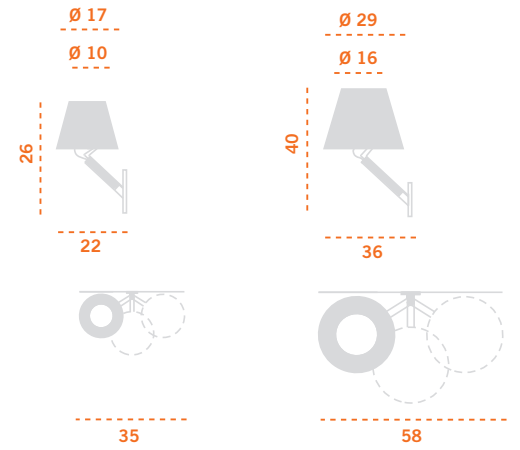



scott

GABRIEL TEIXIDÓ



Colgantes metálicos con cristal opal blanco. Se fabrican en dos medidas.

BOMBILLAS

- Mini:
1x60 W máx. (E-14)
- Grande:
1x100 W máx. (E-27)

ACABADOS

Cromo.

Metallic pendant lamps with white opal glass. Available in two sizes.

BULBS

- Mini:
1x60 W max. (E-14)
- Big:
1x100 W max. (E-27)

FINISHES

Chrome.

Pendelleuchte aus Metall mit weißem Opalglas. In zwei Größen erhältlich.

LAMPE

- Klein:
1x60 W max. (E-14)
- Groß:
1x100 W max. (E-27)

OBERFLÄCHE

Chrom.

54

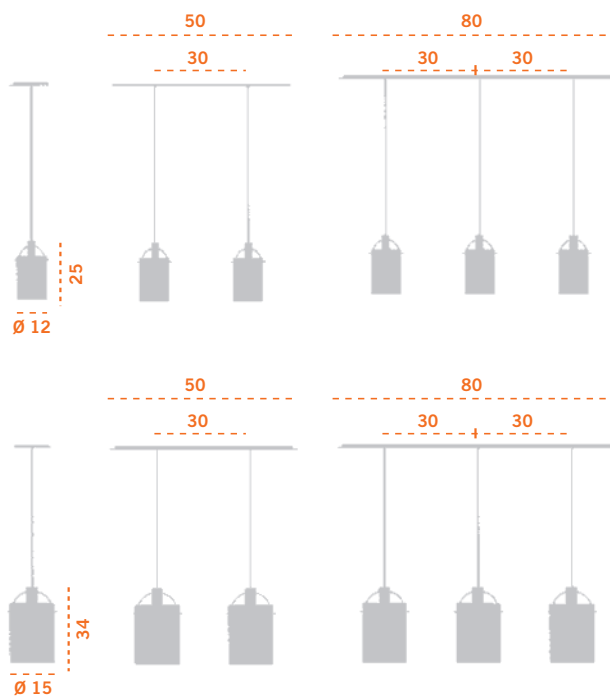



scott

GABRIEL TEIXIDÓ

Plafones metálicos con cristal opal blanco. Se fabrican en dos medidas.

BOMBILLAS

- Mini:
1x60 W máx. (E-14)
- Grande:
1x100 W máx. (E-27)

ACABADOS

Cromo.

Metallic ceiling lamps with white opal glass. Available in two sizes.

BULBS

- Mini:
1x60 W max. (E-14)
- Big:
1x100 W max. (E-27)

FINISHES

Chrome.

Deckenleuchte aus Metall und weißem Opalglas. In zwei Größen erhältlich.

LAMPE

- Klein:
1x60 W max. (E-14)
- Groß:
1x100 W max. (E-27)

OBERFLÄCHE

Chrom.

56

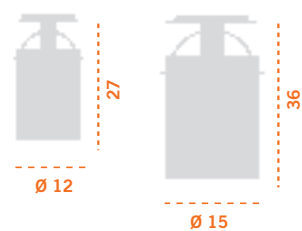



harry

PORCUATRO

58



Lámpara pie suelo exterior e interior. Aplicable a mesas de jardín y terrazas. Se fabrica en versión para fijarla en la tierra, y como luz de ambiente exterior. Equipada con cable 10 metros.

BOMBILLAS
1x25 W máx. (E-27 bajo consumo)

ACABADOS
Pincho de acero inoxidable.
Pantalla: polipropileno blanco.
Base pie: titanio, blanco y naranja.

Floor lamp designed for indoor and outdoor use. Also adapted for garden tables and terraces. Can be put directly into the ground or as auxiliary outdoor light. Equipped with 10 m of cable.

BULBS
1x25 W max. (E-27 low energy)

FINISHES
Spike in stainless steel.
Lampshade: white polypropylene.
Foot base: titanium, white and orange.

Stehleuchte für den Innen- und Außenraum. Der Leuchtenfuß ist als Erdspieß zum Einstecken in das Erdreich ausgebildet. Kabellänge 10 Meter. Als Zubehör ist ein Standfuß lieferbar.

LAMPE
1x25 W max.
(Kompaktleuchtstofflampe E27)

OBERFLÄCHE
Leuchtenfuß: Edelstahl.
Lampenschirm: Polypropylen opalweiß.
Standfuß: metall / farbe titan, weiß oder orange.



Apto exteriores, IP 64.
For outdoor use, IP 64.
Für Außenanwendung, IP 64.



SELECCIÓN DELTA
ADI-FAD 2005

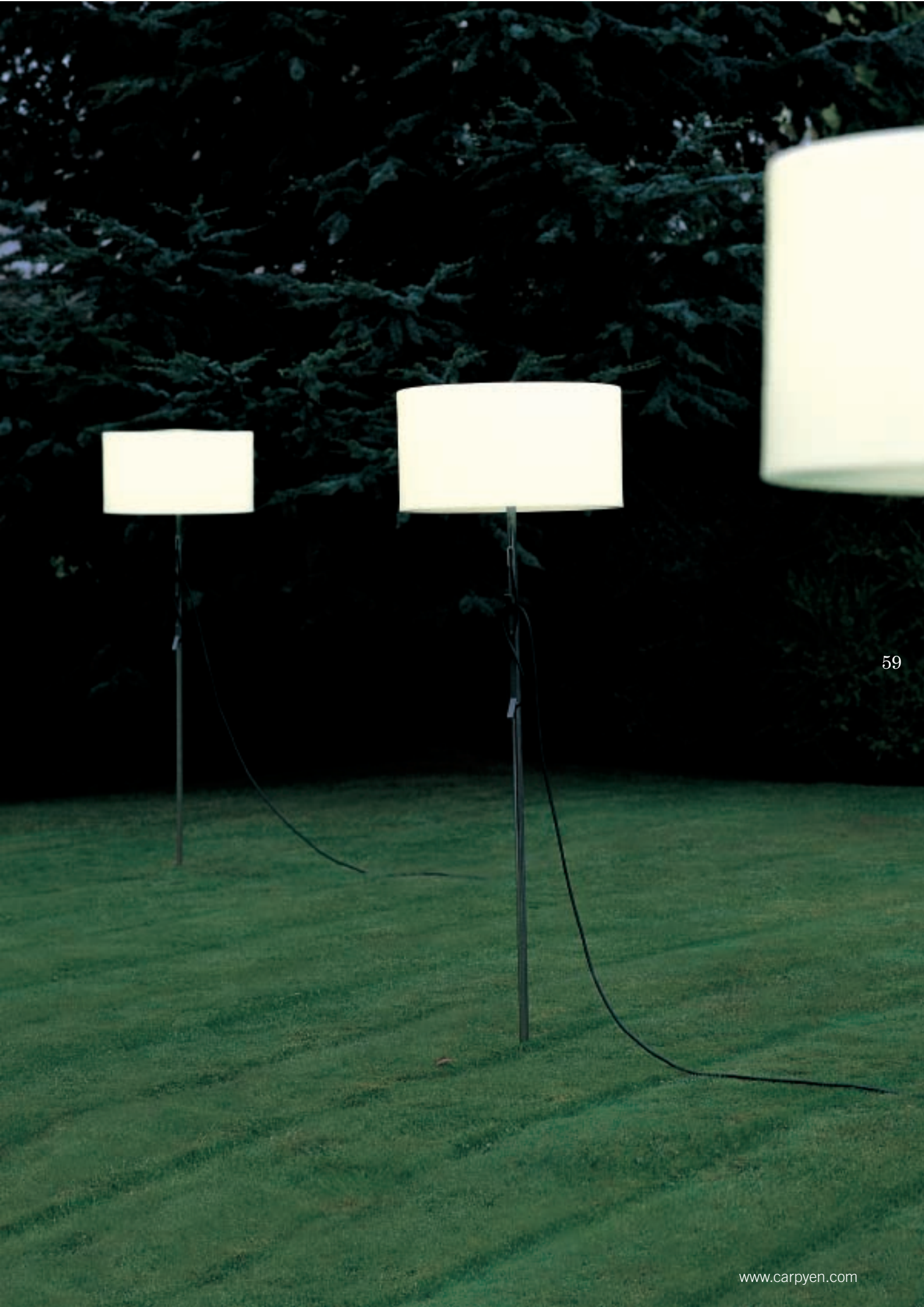

harry

PORCUATRO

60

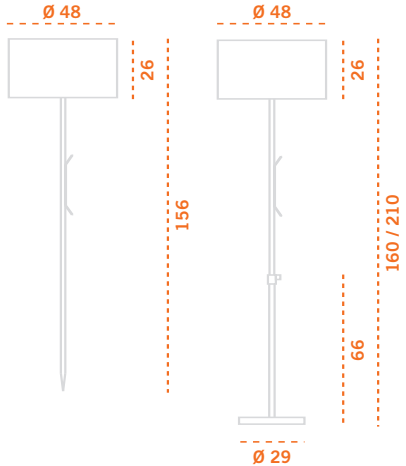



harry jardín

PORCUATRO

Lámpara preparada para exterior, aplicable a terrazas y jardines. La base es metálica zincada, la cual permite enrollar el cable sobrante que no utilizemos. Equipada con cable 10 metros.

BOMBILLAS
1x25 W máx. (E-27 bajo consumo)

ACABADOS
Pantalla: polipropileno blanco.

Lamp designed for outdoor use, adapted for garden tables and terraces. The zinc plated metal base permits coiling the leftover cable. Equipped with 10 m of cable.

BULBS
1x25 W max. (E-27 low energy)

FINISHES
Lampshade: white polypropylene.

Bodenleuchte für den Innen- und Außenraum. Kabel aufrollbar. Kabellänge 10 Meter.

LAMPE
1x25 W max.
(Kompaktleuchtstofflampe E-27)

OBERFLÄCHE
Lampenschirm: Polypropylen opalweiß.

62



Apto exteriores, IP 64.
For outdoor use, IP 64.
Für Außenanwendung, IP 64.





harry
PORCUATRO

64

HARRY plafón / ceiling lamp / deckenleuchten

www.carpyn.com

Plafón preparado para exterior.

BOMBILLAS

1x25 W máx. (E-27 bajo consumo)

ACABADOS

Pantalla: polipropileno blanco.

Ceiling lamp designed for outdoor use.

BULBS

1x25 W max. (E-27 low energy)

FINISHES

Lampshade: white polypropylene.

Deckenleuchte für den Innen- und Außenraum.

LAMPE

1x25 W max.

(Kompaktleuchtstofflampe E-27)

OBERFLÄCHE

Lampenschirm: Polypropylen opalweiß.



Apto exteriores, IP 64.

For outdoor use, IP 64.

Für Außenanwendung, IP 64.

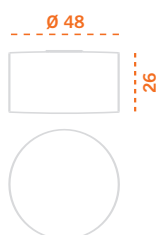

harry

PORCUATRO

66



HARRY colgante / suspension lamp / pendelleuchten

www.carpyen.com

Colgante preparado para exterior muy fácil de instalar, contiene un cable de sujeción regulable que permite colocarlo en cualquier techo. Aplicable a mesas de jardín y terrazas. Equipado con cable eléctrico de 10 m.

BOMBILLAS

1x25 W máx. (E-27 bajo consumo)

ACABADOS

Pantalla: polipropileno blanco.

Suspension lamp designed for outdoor use, very easy to install thanks to its adjustable cable which allows to install it on any ceiling. Also adapted for garden tables and terraces. Equipped with 10 m of electric cable.

BULBS

1x25 W max. (E-27 low energy)

FINISHES

Lampshade: white polypropylene.

Pendelleuchte für den Innen- und Außenraum. Einfachste Montage aufgrund justierbarem-Kabel mit einer Gesamtlänge von 10 m.

LAMPE

1x25 W max.

(Kompaktleuchtstofflampe E-27)

OBERFLÄCHE

Lampenschirm: Polypropylen opalweiß.



Apto exteriores, IP 64.
For outdoor use, IP 64.
Für Außenanwendung, IP 64.



HARRY pie / floor / stehleuchte



HARRY jardín / garden / garten



HARRY plafón / ceiling lamp / deckenleuchten



HARRY colgante / suspension lamp / pendelleuchten

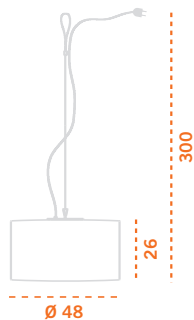

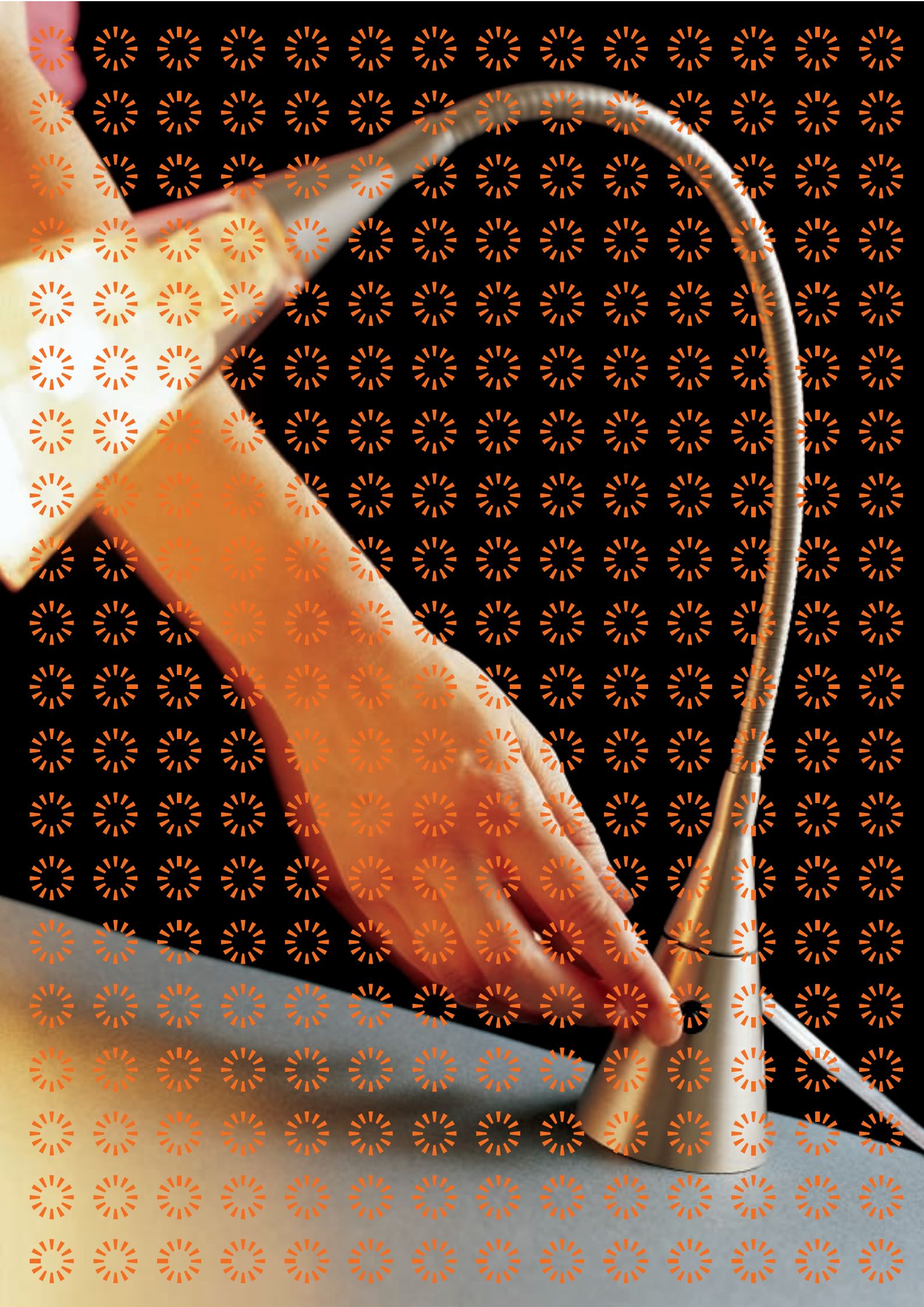

2

viper

DAIFUKU DESIGNS

Aplique o plafón flexible metálico con reflector de plástico óptico transparente. Interruptor opcional.

BOMBILLAS
1x30 W máx.
(E-14 reflector 39 mm)

ACABADOS
Níquel mate.

Flexible metallic ceiling or wall lamp with optical transparent plastic reflector. Optional switch.

BULBS
1x30 W max. Incandescent
(E-14 reflector 39 mm)

FINISHES
Matt nickel.

Decken-oder Wandleuchte mit Metall-Flexschlauch und transparentem Kunststoffreflektor. Integrierter Schalter optional.

LAMPE
1x30 W max. (E14 R39)

OBERFLÄCHE
Nickel matt.

IP 20

70

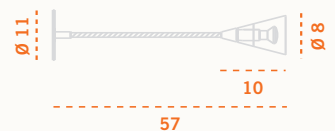



viper
DAIFUKU DESIGNS



72

Lámpara pinza metálica con reflector de plástico óptico transparente e interruptor en la base. Apertura de pinza: 5,5 cm.

BOMBILLAS
1x30 W máx.
(E-14 reflector 39 mm)

ACABADOS
Níquel mate.

Metallic clip-on lamp (5,5 cm opening) with a transparent optical plastic reflector and a switch in the base.

BULBS
1x30 W max. Incandescent
(E-14 reflector 39 mm)

FINISHES
Matt nickel.

Klemmleuchte mit Metall-Flexschlauch und transparentem Kunststoffreflektor (Klemmöffnung max. 5,5 cm). Schalter integriert.

LAMPE
1x30 W max. (E14 R39)

OBERFLÄCHE
Nickel matt.

IP 20

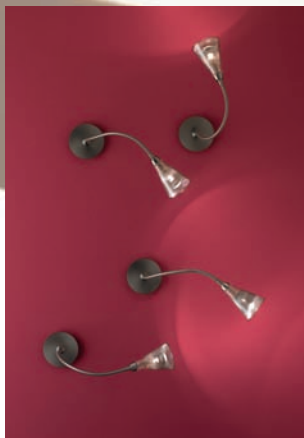
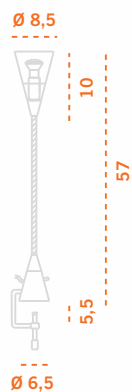

VIPER aplique o plafón / wall lamp or ceiling / decken-oder Wandleuchte



VIPER pinza / clip-on / klemmleuchte

python

DAIFUKU DESIGNS



Aplique o plafón flexible metálico con bombilla LED. Interruptor en la base.

BOMBILLA
1,4 W. 45 lumen. Color blanco (6000 K). Ángulo de apertura 60°.

ACABADOS
Níquel mate.

Metallic wall or ceiling lamp with LED bulb. Switch in the base.

BULBS
1,4 W. 45 lumen. White colour (6000 K). 60° lighting angle.

FINISHES
Matt nickel.

Decken- oder Wandleuchte mit Metall-Flexschlauch und LED-Lampe. Schalter im Fuß integriert.

LAMPE
1,4 W. 45 lumen. Lichtfarbe neutralweiß (6000 K). Ausstrahlungswinkel 60°.

OBERFLÄCHE
Nickel matt.

74



VENTAJAS DEL LED

- Consumo mínimo.
- Luz concentrada.
- Calor inexistente.
- Permite una gran calidad de lectura al usuario sin emisión de UV.
- Duración LED aproximadamente 100.000 horas.

ADVANTAGES OF LED

- Low energy.
- Focused light.
- Unappreciable heat.
- Allows the user to have a high quality light for reading without any UV emission.
- LED lifespan: aprox. 100.000 hours.

VORTEILE DER LED

- Geringer Energieverbrauch.
- Gerichtetes Licht.
- Keine Hitzeentwicklung.
- Qualitatives Licht ohne UV Emission.
- Lebensdauer ca. 100.000 Stunden.





python

DAIFUKU DESIGNS

76



Lámpara sobremesa o pinza metálica con bombilla LED. Interruptor en la base. Apertura de la pinza 5,5 cm.

BOMBILLA
1,4 W. 45 lumen. Color blanco (6000 K). Ángulo de apertura 60°.

ACABADOS
Níquel mate.

Metallic table lamp or clip-on lamp (5,5 cm opening) with LED bulb. Switch in the base.

BULBS
1,4 W. 45 lumen. White colour (6000 K). 60° lighting angle.

FINISHES
Matt nickel.

Tischleuchte oder Klemmleuchte mit Metall-Flexschlauch und LED-Lampe. Schalter im Fuß integriert.

LAMPE
1,4 W. 45 lumen. Lichtfarbe neutralweiß (6000 K). Ausstrahlungswinkel 60°.

OBERFLÄCHE
Nickel matt.

VENTAJAS DEL LED

- Consumo mínimo.
- Luz concentrada.
- Calor inexistente.
- Permite una gran calidad de lectura al usuario sin emisión de UV.
- Duración LED aproximadamente 100.000 horas.

ADVANTAGES OF LED

- Low energy.
- Focused light.
- Unappreciable heat.
- Allows the user to have a high quality light for reading without any UV emission.
- LED lifespan: aprox. 100.000 hours.

VORTEILE DER LED

- Geringer Energieverbrauch.
- Gerichtetes Licht.
- Keine Hitzeentwicklung.
- Qualitatives Licht ohne UV Emission.
- Lebensdauer ca. 100.000 Stunden.

PYTHON pinza / clip-on / klemmleuchte

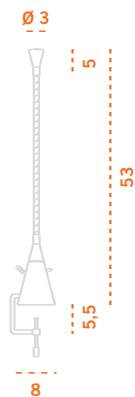

PYTHON sobremesa / table / tischleuchte

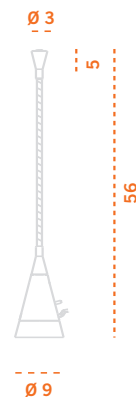





Plafón o aplique metálico con rejilla gris. Cuerpo en polietileno y marco en extrusión de aluminio anodizado.

BOMBILLAS
1x30 W máx. (GE lighting GRZ-10t) bajo consumo.

ACABADOS
Anodizado gris natural.

Metallic ceiling or wall lamp with grey grill. Body made of polyethylene and frame in extruded anodized aluminium.

BULBS
1x30 W max. (GE lighting GRZ-10t) low energy.

FINISHES
Anodized natural grey.

Decken- oder Wandleuchte mit grauem Gitter, Leuchtenkörper aus Polyäthylen und Rahmen aus eloxiertem Aluminium.

LAMPE
1x30 W max. Kompaktleuchtstofflampe GRZ-10t (GE lighting).

OBBERFLÄCHE
Grau eloxiert.

IP 40

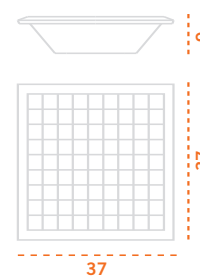
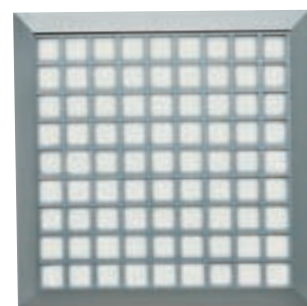

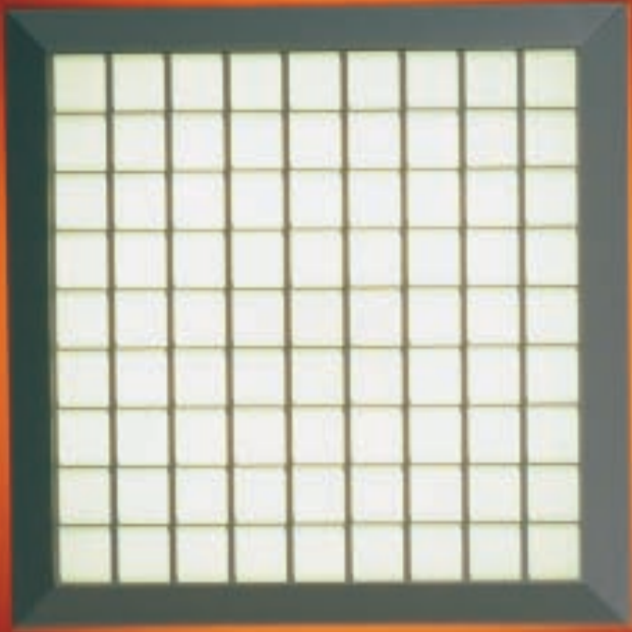

basic

PASCUAL SALVADOR



Plafón o aplique metálico con cristal opal blanco. Tres medidas.

BOMBILLAS

- 20 cm:
1x100 W máx. (R7S 80 mm)
- 30 cm:
1x200 W máx. (R7S 118 mm)
2x26 W máx. (G-24 D3)
- 46 cm:
1x300 W máx. (R7S 118 mm)
3x26 W máx. (G-24 D3)

ACABADOS

Blanco, plomo metalizado y oro metalizado.

Metallic wall light or ceiling lamp with white opal difuser. Available in three sizes.

BULBS

- 20 cm:
1x100 W max. (R7S 80 mm)
- 30 cm:
1x200 W max. (R7S 118 mm)
2x26 W max. (G-24 D3)
- 46 cm:
1x300 W max. (R7S 118 mm)
3x26 W max. (G-24 D3)

FINISHES

White, metallic lead and metallic gold.

80

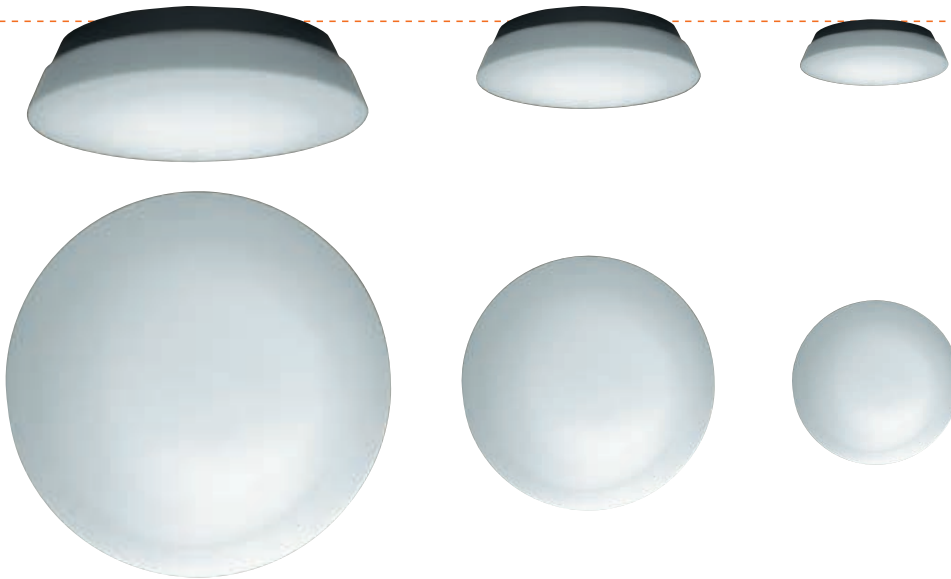

Decken- oder Wandleuchte aus Metall mit opal-weißem Glas. In drei Größen erhältlich.

LAMPE

- 20 cm:
1x100 W max. (R7S 80 mm)
- 30 cm:
1x200 W max. (R7S 118 mm)
2x26 W (G-24 D3)
- 46 cm:
1x300 W max. (R7S 118 mm)
3x26 W (G-24 D3)

OBERFLÄCHE

Weiß, grau- oder gold-metallic.

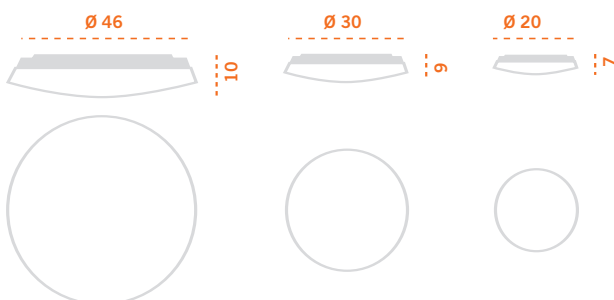

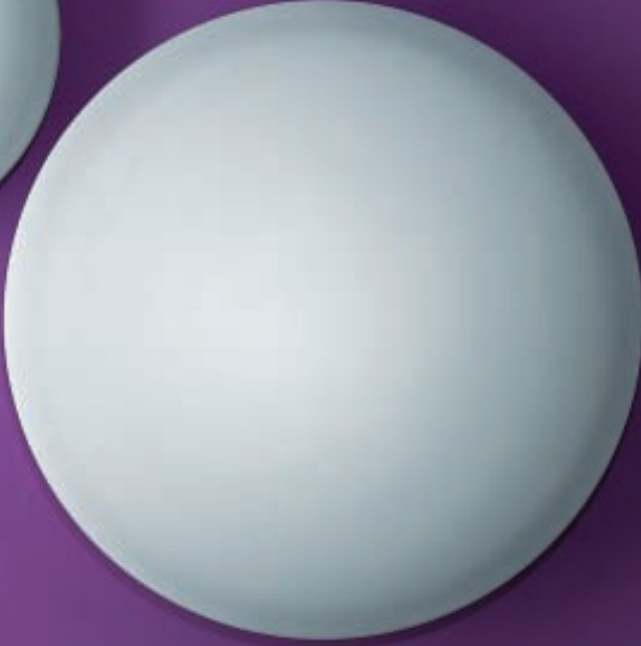

rita

PASCUAL SALVADOR

Plafón o aplique metálico cristal curvado mate. Se fabrica en tres medidas.

BOMBILLAS

- Mini Ø 21 cm:
1x100 W máx. (R7S 80 mm)
- Mediano Ø 30 cm:
1x150 W máx. (R7S 80 mm)
- Grande Ø 45 cm:
1x150 W máx. (R7S 80 mm)

ACABADOS

Cromo y plomo metalizado.

Metal halogen wall and ceiling lamp. Glass opaque bend. Available in three sizes.

BULBS

- Mini Ø 21 cm:
1x100 W max. (R7S 80 mm)
- Medium Ø 30 cm:
1x150 W max. (R7S 80 mm)
- Big Ø 45 cm:
1x150 W max. (R7S 80 mm)

FINISHES

Gold and metallic lead.

Wand- oder Deckenleuchte aus Metall mit gebogenem, mattiertem Glasschirm. In drei Größen erhältlich.

LAMPE

- Klein, 21 cm Durchmesser:
1x100 W max. (R7S 80 mm)
- Medium, 30 cm Durchmesser:
1x150 W max. (R7S 80 mm)
- Groß, 45 cm Durchmesser:
1x150 W max. (R7S 80 mm)

OBERFLÄCHE

Chrom oder grau-metallic.

82

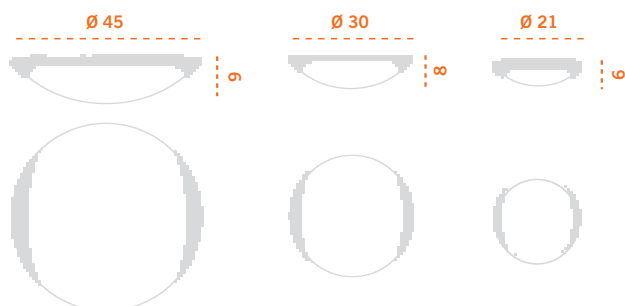

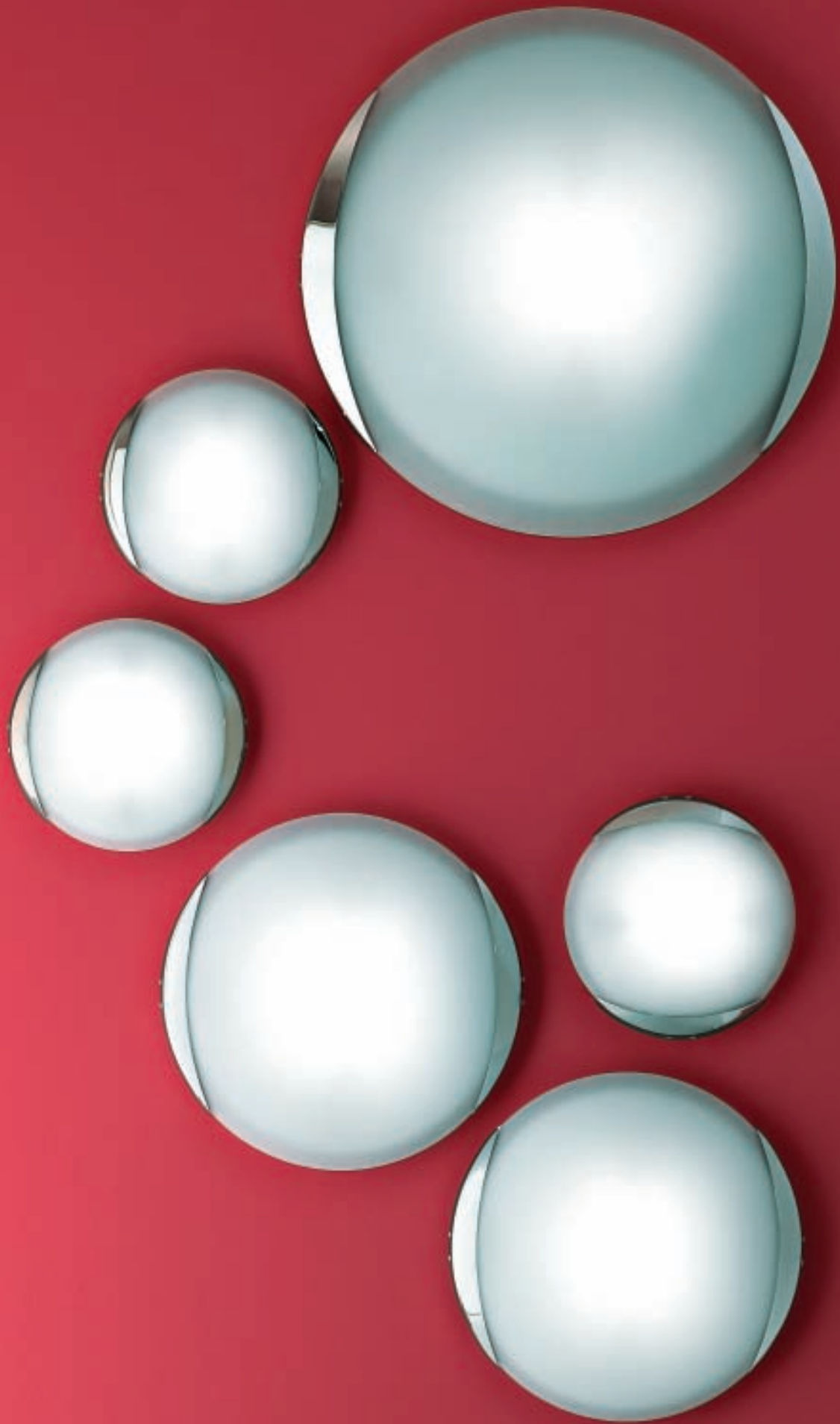

Plafón o aplique metálico con cristal opal blanco. 4 medidas.

BOMBILLAS

- 16 cm: 1x25 W máx. (G9)
Halógena
- 21 cm: 1x60 W máx. (E-14)
- 26 cm: 1x60 W máx. (E-14)
- 31 cm: 2x60 W máx. (E-14)

ACABADOS

Blanco.

Metallic ceiling or wall lamp with white opal glass. Available in 4 sizes.

BULBS

- 16 cm: 1x25 W max. (G9)
Halogen
- 21 cm: 1x60 W max. (E-14)
Incandescent
- 26 cm: 1x60 W max. (E-14)
Incandescent
- 31 cm: 2x60 W max. (E-14)
Incandescent

FINISHES

White.

Decken-oder Wandleuchte aus Metall und weißem Opalglas in 4 verschiedenen Durchmessern.

LAMPE

- 16 cm: 1x25 W max. (G9)
Halogen
- 21 cm: 1x60 W max. (E14)
- 26 cm: 1x60 W max. (E14)
- 31 cm: 2x60 W max. (E14)

OBERFLÄCHE

Gehäuse: weiß.
Glas: opalweiß.

IP 44

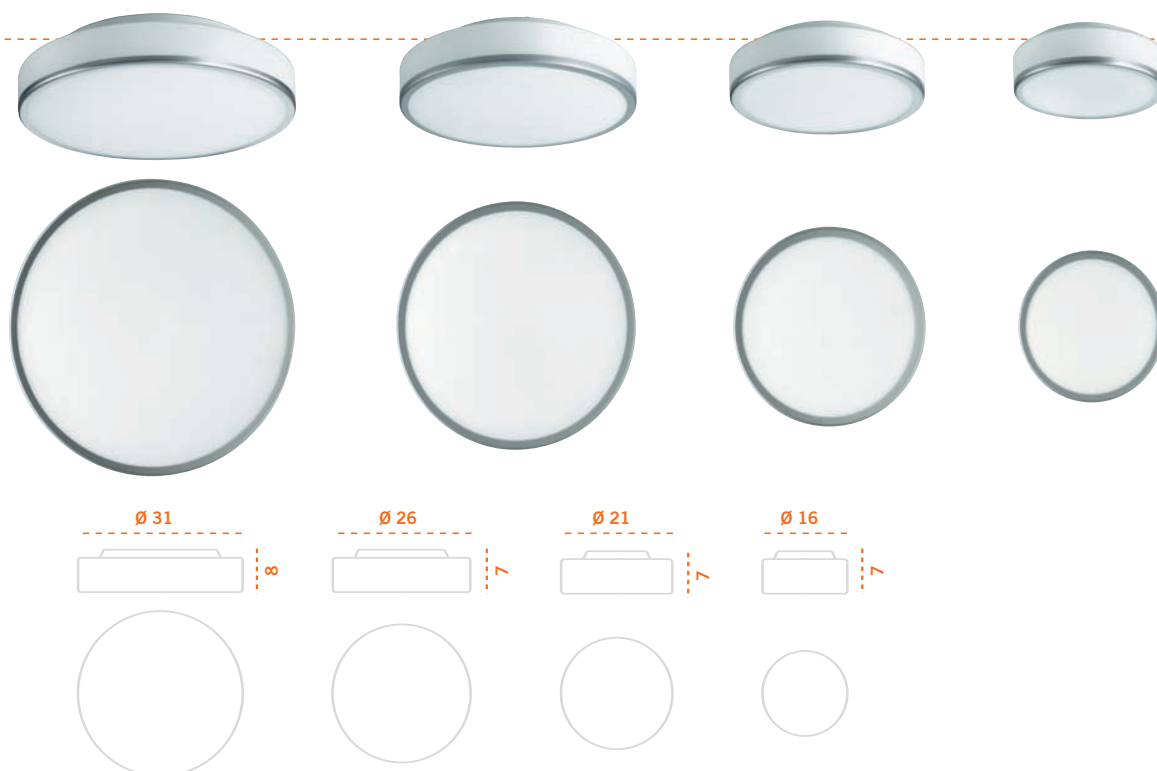



Plafón o aplique metálico con cristal opal blanco, de pequeñas dimensiones.

BOMBILLAS
1x60 W máx. (E-14)

ACABADOS
Cromo.

Metallic ceiling or wall lamp with white opal glass of small dimensions.

BULBS
1x60 W max. (E-14)

FINISHES
Chrome.

Wand- oder Deckenleuchte aus Metall mit opalweißem Glas.

LAMPE
1x60 W max. (E-14)

OBERFLÄCHE
Chrom.



IP 40





waki

DAIFUKU DESIGNS



Plafón o aplique metálico con cristal opal blanco, la versión individual se fábrica en dos medidas. Únicamente la versión pequeña se fábrica con regleta dos o tres cristales que pueden ser usados tanto vertical como horizontal.

BOMBILLAS

- 11 cm:
1x60 W máx. (E-14)
- 17 cm:
1x100 W máx. (E-27)
1x26 W máx. (GX24 q3)

ACABADOS

Individual: cromo.
Regletas: acero inoxidable.

Metallic ceiling or wall lamp with white opal glass. The individual version is available in two sizes. Only the small size lamp can be installed on the track of 2 or 3 lights, which can be mounted vertically or horizontally.

BULBS

- 11 cm:
1x60 W max. (E-14)
Incandescent
- 17 cm:
1x100 W max. (E-27)
Incandescent
1x26 W max. (GX24 q3)
Low energy

FINISHES

Individual: chrome.
Track: stainless steel.

Decken- oder Wandleuchte mit Metallfuß und opalweißem Glas. Einzelleuchte in 2 verschiedenen Durchmessern, kleine Version auch als 2- oder 3-fach Leuchte lieferbar. Für vertikale und horizontale Montage geeignet.

LAMPE

- 11 cm:
1x60 W max. (E-14)
- 17 cm:
1x100 W max. (E-27)
1x26 W max. (GX24 q3)

OBERFLÄCHE

Gehäuse Einzelleuchte: chrom.
Gehäuse 2/3-fach Leuchte: edelstahl.
Glas: opalweiß.

IP 40

88

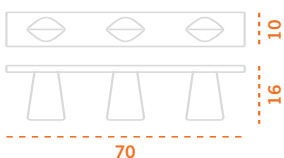
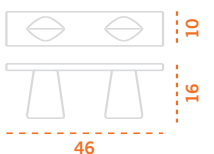
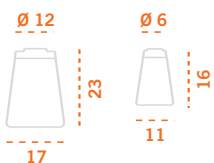



mini

Aplique o plafón metálico con cristal, de pequenas dimensións.

BOMBILLAS
1x40 W máx. (G9)

ACABADOS
Cromo.

Metallic wall or ceiling lamp with glass of small dimensions.

BULBS
1x40 W max. (G9)

FINISHES
Chrome.

Wand- oder Deckenleuchte mit Glas.

LAMPE
1x40 W max. (G9)

OBERFLÄCHE
Chrom.

IP 44



90

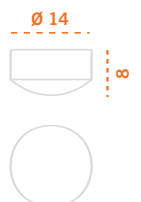



odyssey

GABRIEL TEIXIDÓ

Plafones en cristal óptico,
estructura metálica. Se fabrica en
dos versiones, uno o dos cristales
y dos diámetros cada modelo.

BOMBILLAS

- Ø 57 cm: 1x250 W máx. (E-27)
- Ø 74 cm: 1x250 W máx. (E-27)

ACABADOS

Cromo.

Ceiling light with optical glass,
metallic body. Available in two
versions. One or two glasses shade,
and two diameter in each version.

BULBS

- Ø 57 cm: 1x250 W max. (E-27)
- Ø 74 cm: 1x250 W max. (E-27)

FINISHES

Chrome.

Deckenleuchte mit optischem
Glas und Halterung aus Metall.
Mit einem oder zwei Schirmen,
jeweils in zwei Durchmessern
erhältlich.

LAMPE

- Ø 57 cm: 1x250 W max. (E-27)
- Ø 74 cm: 1x250 W max. (E-27)

OBERFLÄCHE

Chrom.

92

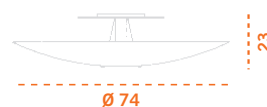
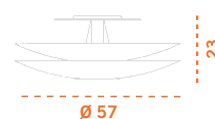
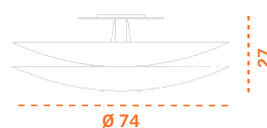



boxster

PASCUAL SALVADOR



Plafón o aplique metálico cristal curvado blanco. Se fabrican en tres medidas.

BOMBILLAS

- Mini:
1x100 W máx. (R7S 80 mm)
o bajo consumo 2x13 W máx.
(G24-Q1)
- Mediano:
1x200 W máx. (R7S 118 mm)
o bajo consumo 2x26 W máx.
(G24-Q3)
- Grande:
1x300 W máx. (R7S 118 mm)
o bajo consumo 3x26 W máx.
(G24-Q3)

ACABADOS

Cromo y plomo metalizado.

Metal wall or ceiling lamp. White curved glass. Available in 3 sizes.

BULBS

- Mini:
1x100 W max. (R7S 80 mm) or
low energy 2x13 W max. (G24-Q1)
- Medium:
1x200 W max. (R7S 118 mm)
or low energy 2x26 W max.
(G24-Q3)
- Big:
1x300 W max. (R7S 118 mm)
or low energy 3x26 W max.
(G24-Q3)

FINISHES

Chrome and metallic lead.

Decken- oder Wandleuchte aus weißem Glas. In drei Größen lieferbar.

LAMPE

- Mini:
1x100 W max. (R7S 80 mm)
oder 2x13 W (G24-Q1)
- Medium:
1x200 W max. (R7S 118 mm)
oder 2x26 W (G24-Q3)
- Groß:
1x300 W max. (R7S 118 mm)
oder 3x26 W (G24-Q3)

OBERFLÄCHE

Chrom oder grau-metallic.

94

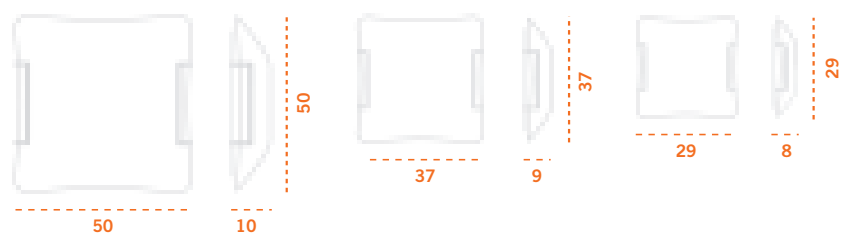



top

PASCUAL SALVADOR

Plafones en tres formas de cristal plano mate templado.

BOMBILLAS
1x200 W máx. (R7S 118 mm)

ACABADOS
Oro y cromo.

Ceiling lamp in three types of flat, toughened matt glass.

BULBS
1x200 W max. (R7S 118 mm)

FINISHES
Gold and chrome.

Deckenleuchte mit leicht mattierter Glasabdeckung. In drei Formen erhältlich.

LAMPE
1x200 W max. (R7S 118 mm)

OBERFLÄCHE
Gold oder chrom.

96

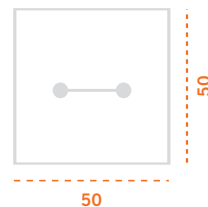
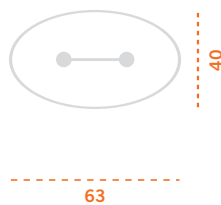
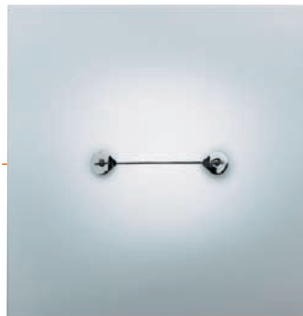



clara

GABRIEL TEIXIDÓ

Plafón metálico de cristal.

BOMBILLAS
1x150 W máx. (E-27)

ACABADOS
Cromo y plomo metalizado.
Cristal: Blanco, rosa y verde.

Metallic ceiling lamp with glass.

BULBS
1x150 W max. (E-27)

FINISHES
Chrome and metallic lead.
Glasses: white, pink and green.

Deckenleuchte aus Metall und
Glas.

LAMPE
1x150 W max. (E-27)

OBERFLÄCHE
Chrom oder grau-metallic.
Glas: weiß, bernstein oder grün.

98

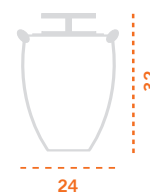
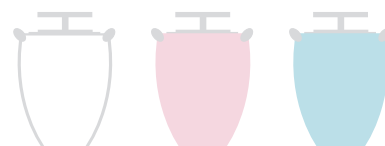



sunset

GABRIEL TEIXIDÓ

Plafón o aplique metálico cristal decorado mate. Se fabrica en dos medidas.

BOMBILLAS

- 30 cm:
1x150 W máx. (R7S 80 mm)
- 45 cm:
1x150 W máx. (R7S 80 mm)

ACABADOS

Cromo, oro y plomo metalizado.

Metal halogen wall and ceiling lamp. Glass opaque decorated. Available in two sizes.

BULBS

- 30 cm:
1x150 W max. (R7S 80 mm)
- 45 cm:
1x150 W max. (R7S 80 mm)

FINISHES

Gold, chrome and metallic lead.

Decken- oder Wandleuchte aus Metall und mattiertem Glas. In zwei Größen erhältlich.

LAMPE

- 30 cm:
1x150 W max. (R7S 80 mm)
- 45 cm:
1x150 W max. (R7S 80 mm)

OBERFLÄCHE

Chrom, gold- oder grau-metalllic.



100

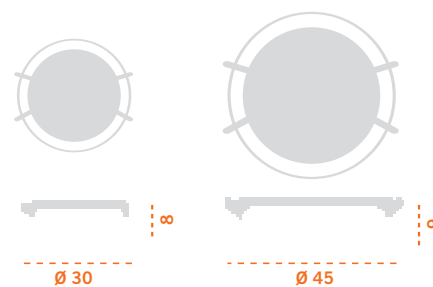



Aplique y plafón metálico halógeno.

BOMBILLAS
1x150 W máx. (R7S 80 mm)

ACABADOS
Cromo.

Halogen wall lamp or ceiling lamp.

BULBS
1x150 W max. (R7S 80 mm)

FINISHES
Chrome.

Wand- oder Deckenleuchte aus
Metall.

LAMPE
1x150 W max. (R7S 80 mm)

OBERFLÄCHE
Chrom.

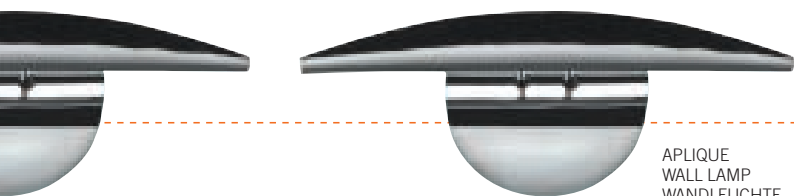

APLIQUE
WALL LAMP
WANDLEUCHTE

102

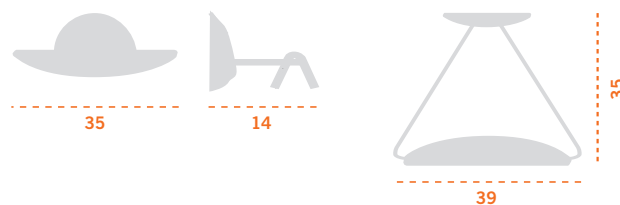
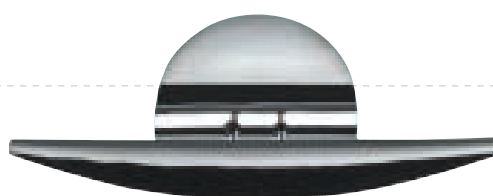



hotel

104



Aplique metálico con pantalla en algodón, interruptores en la base. Se fabrica con pantalla cuadrada o redonda.

BOMBILLAS
1x60 W máx. (E-14)

ACABADOS
Níquel mate.
Pantallas: blanca, beige y negra.

Metallic wall lamp with cotton lampshade, switches in the base. Made with square or round shade.

BULBS
1x60 W max. (E-14)

FINISHES
Matt nickel.
Lampshades: white, beige and black.

Wandleuchte aus Metall mit quadratischem oder rundem Lampenschirm aus Baumwolle und integriertem Schalter.

LAMPE
1x60 W max. (E-14)

OBERFLÄCHE
Nickel matt.
Lampenschirm: weiß, beige oder schwarz.

IP 20



105

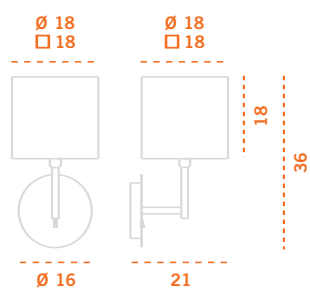

zénit

ALEX SOLER

Aplique metálico en dos medidas con pantalla en policarbonato blanco.

BOMBILLAS
1x100 W máx. (E-27)
2x7-9 W máx. (G23)

ACABADOS
Plomo metalizado.

Metallic wall light, available in two sizes. With polycarbonate white shade.

BULBS
1x100 W max. (E-27)
2x7-9 W max. (G23)

FINISHES
Metallic lead.

Wandleuchte aus Metall in zwei Größen, mit Schirm aus weißem Polycarbonat.

LAMPE
1x100 W max. (E-27)
2x7-9 W max. (G23)

OBERFLÄCHE
Grau-metallic.



106

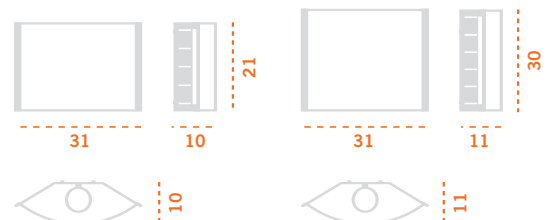



área

GABRIEL TEIXIDÓ



Aplique provisto de doble cristal con la posibilidad de insertar fotos, logos, etc. Se fabrica en dos versiones: con interruptor o sin.

BOMBILLAS
1x100 W máx. (E-27)
1x18 W máx. (G24-D2)

ACABADOS
Anodizado gris natural.

Wall lamp with double glass which gives the possibility to insert photos, logos, etc. Available with or without switch.

BULBS
1x100 W max. (E-27)
1x18 W max. (G24-D2)

FINISHES
Anodized natural grey.

Wandleuchte mit Doppelglas, mit der Möglichkeit Fotos einzufügen. Mit oder ohne Zugschalter lieferbar.

LAMPE
1x100 W max. (E-27)
1x18 W max. (G-24 D2)

OBERFLÄCHE
Grau-eloxiert.



108

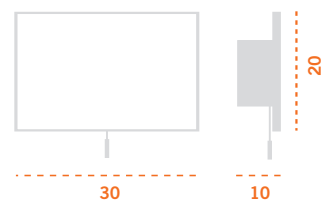
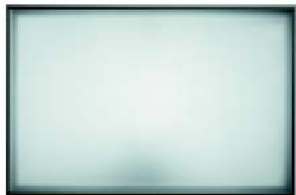



valentina

GABRIEL TEIXIDÓ

Aplique metálico con reflector giratorio 95°.

BOMBILLAS
1x300 W máx. (R7S 118 mm)

ACABADOS
Plomo metalizado.

Metal wall lamp reflector rotates 95°.

BULBS
1x300 W max. (R7S 118 mm)

FINISHES
Metallic lead.

Wandleuchte aus Metall mit 95° schwenkbarem Reflektor.

LAMPE
1x300 W max. (R7S 118 mm)

OBERFLÄCHE
Grau-metallic.

110

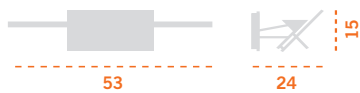



alfa, gamma

GABRIEL TEIXIDÓ

Aplique metálico con pantalla cristal opal blanco.

BOMBILLAS

- Alfa: 1x150 W máx. (E-27)
- Gamma: 1x26 W máx. (G24D3)

ACABADOS

Cromo, plomo metalizado, oro metalizado y titanio.

Metal wall sconce with white opal glass.

BULBS

- Alfa: 1x150 W max. (E-27)
- Gamma: 1x26 W max. (G24D3)

FINISHES

Chrome, metallic lead, metallic gold and titanium.

Wandleuchte mit Gehäuse aus Metall und opalweißem Glas

LAMPE

- Alfa: 1x150 W max. (E-27)
- Gamma: 1x26 W max. (G24D3)

OBERFLÄCHE

Chrom, grau-metallic, gold-metallic oder titan.

112

GAMMA



ALFA



ALFA

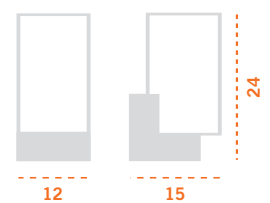
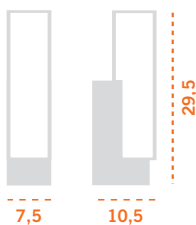



mercury

GABRIEL TEIXIDÓ

Apliques en cristal óptico curvado blanco.

BOMBILLAS

- Mercury 1:
1x100 W máx. (E-27) o
2x18 W máx. (G24-Q2)
- Mercury 2:
2x100 W máx. (E-27) o
2x24 W máx. (2G11)

ACABADOS

Cromo y plomo metalizado.

Wall lamp with white curved optical glass.

BULBS

- Mercury 1:
1x100 W max. (E-27) or
2x18 W max. (G24-Q2)
- Mercury 2:
2x100 W max. (E-27) or
2x24 W max. (2G11)

FINISHES

Chrome and metallic lead.

Wandleuchte mit gebogenem, weißem Glas.

LAMPE

- Mercury 1:
1x100 W max. (E-27) oder
2x18 W max. (G24-Q2)
- Mercury 2:
2x100 W max. (E-27) oder
2x24 W max. (2G11)

OBERFLÄCHE

Chrom oder, grau- metallic.

114



MERCURY 1



MERCURY 2

MERCURY 1



MERCURY 2

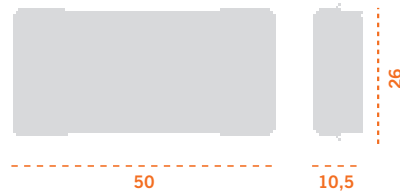





Conjunto de apliques metálicos en aluminio inyectado, su posición de trabajo puede ser vertical u horizontal.

BOMBILLAS

- 50 cm: 1x24 W máx. (2G11)
- 70 cm: 2x24 W máx. (TL5)
- 100 cm: 2x39 W máx. (TL5)
- 130 cm: 2x54 W máx. (TL5)

ACABADOS

Plomo metalizado.

Metallic wall set, injected aluminium. Can be mounted vertically or horizontally.

BULBS

- 50 cm: 1x24 W max. (2G11)
- 70 cm: 2x24 W max. (TL5)
- 100 cm: 2x39 W max. (TL5)
- 130 cm: 2x54 W max. (TL5)

FINISHES

Metalllic lead.

Wandleuchte aus Aluminium. In vier Größen erhältlich. Vertikale und horizontale Montage möglich.

LAMPE

- 50 cm: 1x24 W max. (2G11)
- 70 cm: 2x24 W max. (TL5)
- 100 cm: 2x39 W max. (TL5)
- 130 cm: 2x54 W max. (TL5)

OBERFLÄCHE

Grau-metallic.

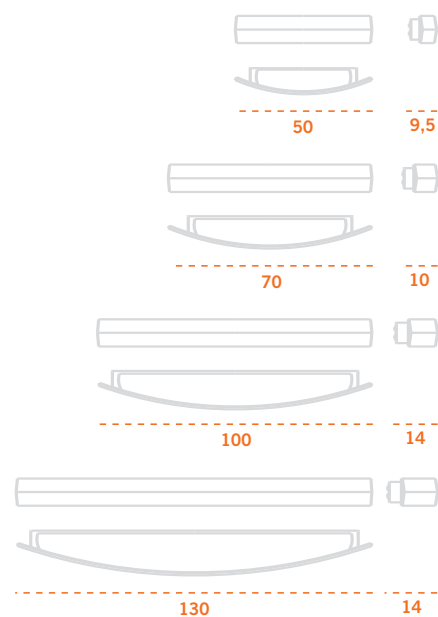



Conjunto de apliques metálicos.
Su posición de trabajo puede ser vertical u horizontal.

BOMBILLAS

- 70 cm: 2x24 W máx. (TL5)
- 100 cm: 2x39 W máx. (TL5)
- 130 cm: 2x54 W máx. (TL5)

ACABADOS

Acero Inoxidable.

Metallic wall lamp set which can
be mounted vertically or
horizontally.

BULBS (low energy)

- 70 cm: 2x24 W max. (TL5)
- 100 cm: 2x39 W max. (TL5)
- 130 cm: 2x54 W max. (TL5)

FINISHES

Stainless steel.

Wandleuchte. Profileuchte aus
Edelstahl. Für vertikale und
horizontale Montage geeignet.

LAMPE

- 70 cm: 2x24 W (TL5)
- 100 cm: 2x39 W (TL5)
- 130 cm: 2x54 W (TL5)

OBERFLÄCHE

Edelstahl.

IP 40

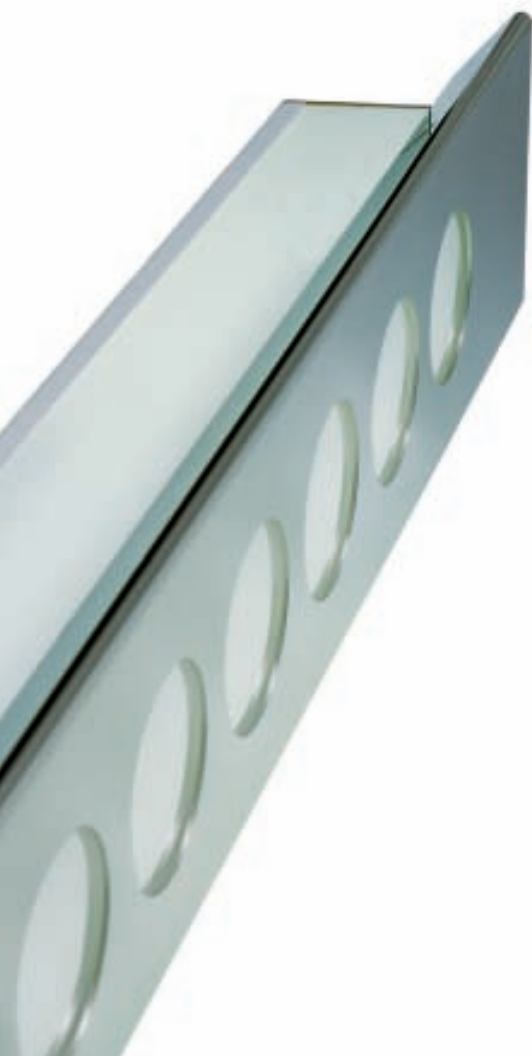



hans

NAHTRANG DISSENY



120



Aplique rectangular metálico, bañador de luz, disponible en dos medidas.

BOMBILLAS

- 41 cm: 2x24 W máx. (TC-L2G11 bajo consumo)
- 72 cm: 2x24 W máx. (TL5)

ACABADOS

- Exterior: gris metalizado, blanco, negro y níquel mate.
- Interior: blanco, teja y verde.

Metallic rectangular wall lamp, wall washer, available in two sizes.

BULBS

- 41 cm: 2x24 W max. (TC-L2G11 low energy)
- 72 cm: 2x24 W max. (TL5)

FINISHES

- Outside: metallic grey, white, black and matt nickel.
- Inside: white, brick and green.

Wandleuchte aus Metall, rechteckig, Lichtaustritt asymmetrisch, lieferbar in 2 Größen.

LAMPE

- 41 cm: 2x24 W max. (TC-L Kompaktleuchtstofflampe)
- 72 cm: 2x24 W max. (T5 Leuchtstofflampe)

OBERFLÄCHE

- Außen: grau metallic, weiß, schwarz oder nickel matt.
- Innen: weiß, rotbraun oder grün.

IP 40

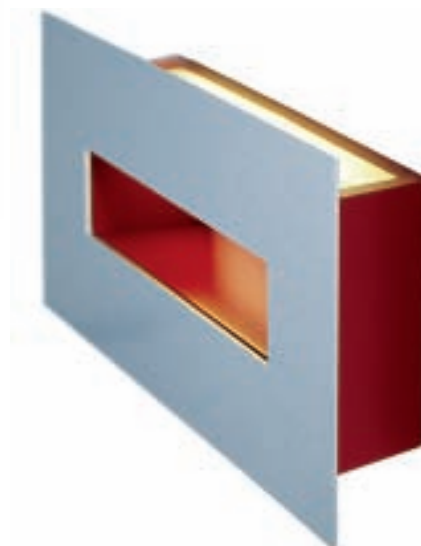

121

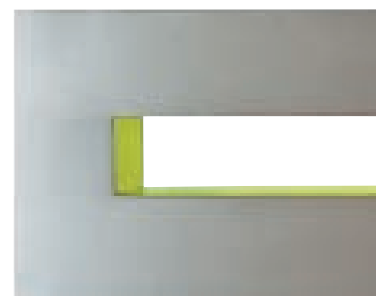
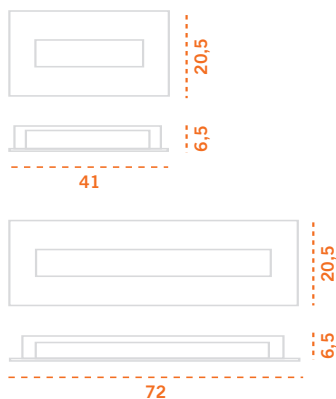

suite, berta

GABRIEL TEIXIDÓ

Aplique cristal curvado gravado mate.

BOMBILLAS

- Suite:
1x150 W máx. (R7S 80 mm)
- Berta:
1x100 W máx. (E-27)
2x7-9 W máx. (G-23)

ACABADOS

Oro, cromo y plomo metalizado.

Wall lamp glass opaque engraved curved.

BULBS

- Suite:
1x150 W max. (R7S 80 mm)
- Berta:
1x100 W max. (E-27)
2x7-9 W max. (G-23)

FINISHES

Gold, chrome and metallic lead.

Wandleuchte mit gebogenem, mattiertem Glasschirm.

LAMPE

- Suite:
1x150 W max. (R7S 80 mm)
- Berta:
1x100 W max. (E-27)
2x7-9 W max. (G-23)

OBERFLÄCHE

Gold, chrom oder grau-metallic.

122

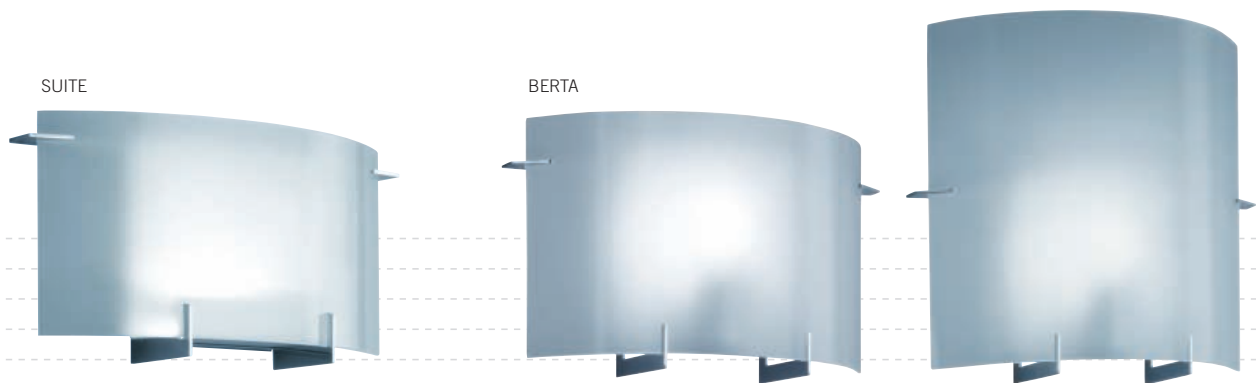

SUITE

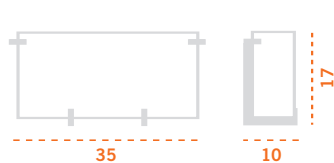

BERTA

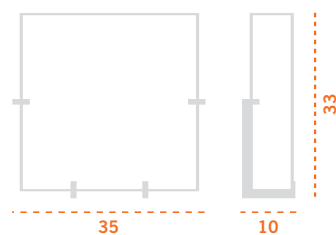
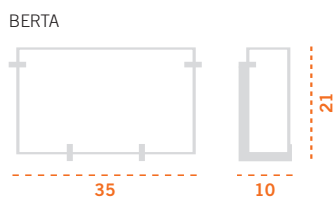



marta

GABRIEL TEIXIDÓ



Aplique metálico cristal curvado blanco.

BOMBILLAS

- 1x100 W máx. (E-27)
- bajo consumo 2x26 W máx. (G24-Q3)

ACABADOS

Cromo, plomo metalizado y oro metalizado.

Wall lamp with white curved glass.

BULBS

- 1x100 W max. (E-27)
- low energy 2x26 W max. (G24-Q3)

FINISHES

Chrome, metallic lead, metallic gold.

Wandleuchte aus Metall mit weißem, gebogenem Glasschirm.

LAMPE

- 1x100 W max. (E-27)
- Kompaktleuchtstofflampe 2x26 W max. (G-24 Q3)

OBERFLÄCHE

Chrom, grau- oder gold-metallic.

124

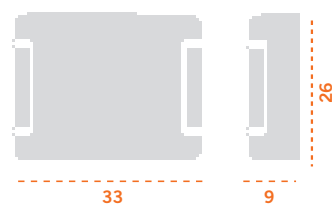



125



erik

CARLES M. SERRA, MIQUEL A. BARBA ARQ

Aplique cristal curvado grabado mate.

BOMBILLAS
1x150 W máx. (R7S 80 mm)

ACABADOS
Cromo y oro.

Wall lamp opaque engraved curved.

BULBS
1x150 W max. (R7S 80 mm)

FINISHES
Gold and chrome.

Wandleuchte mit gebogener, satiniertes Glasabdeckung.

LAMPE
1x150 W max. (R7S 80 mm)

OBERFLÄCHE
Chrom und gold.

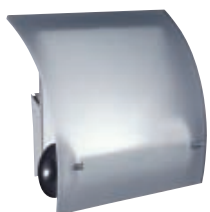

126

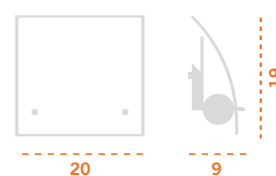



sun

GABRIEL TEIXIDÓ

Aplique cristal curvado mate.

BOMBILLAS
1x150 W máx. (R7S 80 mm)

ACABADOS
Gris metalizado.

Wall lamp in opaque curved glass.

BULBS
1x150 W max. (R7S 80 mm)

FINISHES
Metallic grey.

Wandleuchte mit gebogenem,
mattiertem Glasschirm.

LAMPE
1x150 W max. (R7S 80 mm)

OBERFLÄCHE
Grau-metallic.

128



26

8



kao

PASCUAL SALVADOR

Aplique cristal curvado mate.

BOMBILLAS
1x75 W máx. (B-15d)

ACABADOS
Cromo.

Wall lamp in opaque curved glass.

BULBS
1x75 W max. (B-15d)

FINISHES
Chrome.

Wandleuchte mit mattiertem,
gebogenem Glas.

LAMPE
1x75 W max. (B-15d)

OBERFLÄCHE
Chrom.

130

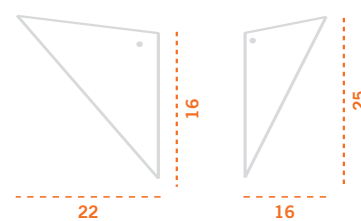



ris

GABRIEL TEIXIDÓ

132

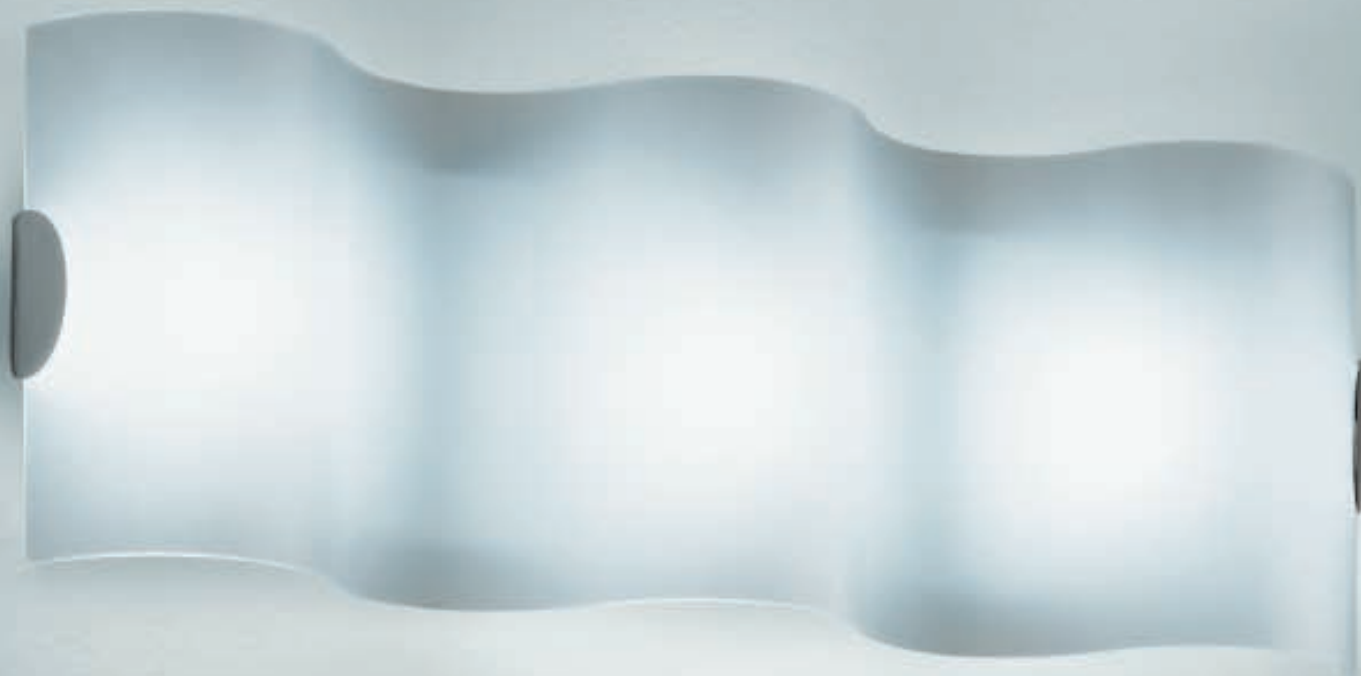

Apliques en cristal curvado grabado mate. Se fabrica en dos medidas.

BOMBILLAS

- Ris 2:
2x60 W máx. (E-14)
2x5-7-9 W máx. (G23)
- Ris 3:
3x60 W máx. (E-14)
3x5-7-9 W máx. (G23)

ACABADOS

Cromo, oro y plomo metalizado.

Wall sconce with a wavy, frosted, engraved glass. Available in two sizes.

BULBS

- Ris 2:
2x60 W max. (E-14)
2x5-7-9 W max. (G23)
- Ris 3:
3x60 W max. (E-14)
3x5-7-9 W max. (G23)

FINISHES

Polished chrome, gold or metallic lead.

Wandleuchte mit gebogenem, mattiertem Glasschirm. In drei Größen erhältlich.

LAMPE

- Ris 2:
2x60 W max. (E-14)
2x5-7-9 W max. (G23)
- Ris 3:
3x60 W max. (E-14)
3x5-7-9 W max. (G23)

OBERFLÄCHE

Chrom, gold oder grau-metallic.

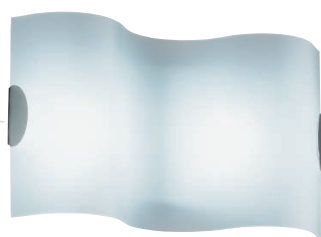
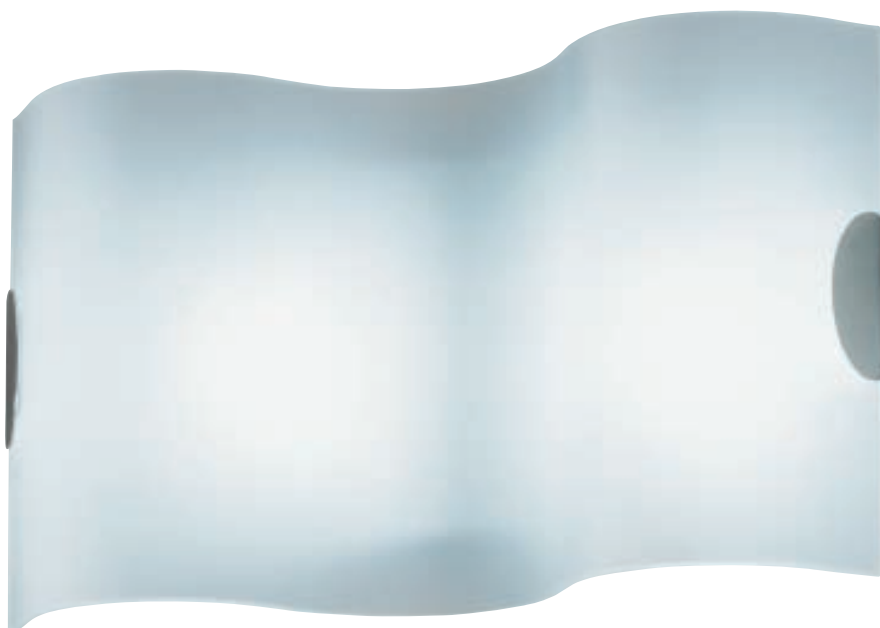

RIS 2

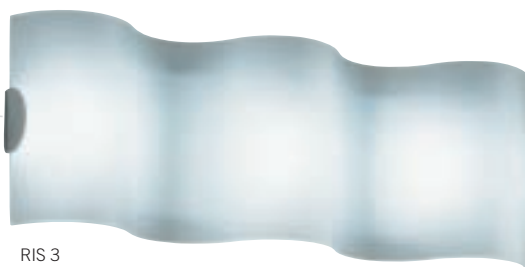

RIS 3

RIS 2



35

20

RIS 3



56

20

RIS 2, RIS 3



9

20

hamilton

PASCUAL SALVADOR



Plafón o aplique en cristal curvado mate. Se fabrica en cuatro medidas.

BOMBILLAS

- Rectangular, 30 cm:
1x100 W (E-27)
1x26 W (G-24 D3)
- Cuadrado, 30 cm:
1x100 W (R7S 118 mm)
2x18 W (TC-L2G11)
- Cuadrado, 38 cm:
1x200 W (R7S 118 mm)
2x24 W (TC-L2G11)
- Cuadrado, 50 cm:
1x300 W (R7S 118 mm)
2x36 W (TC-L2G11)

ACABADOS

Cromo.

Wall or ceiling lamp with curved frosted glass. Available in four sizes.

BULBS

- Rectangle, 30 cm:
1x100 W (E-27)
1x26 W (G-24 D3)
- Square, 30 cm:
1x100 W (R7S 118 mm)
2x18 W (TC-L2G11)
- Square, 38 cm:
1x200 W (R7S 118 mm)
2x24 W (TC-L2G11)
- Square, 50 cm:
1x300 W (R7S 118 mm)
2x36 W (TC-L2G11)

FINISHES

Chrome.

Wand- oder Deckenleuchte aus Metall mit gebogenem, mattiertem Glas. In vier Größen erhältlich.

LAMPE

- Rechteckig, 30 cm:
1x100 W (E-27)
1x26 W (G-24 D3)
- Quadratisch, 30 cm:
1x100 W (R7S 118 mm)
2x18 W (TC-L2G11)
- Quadratisch, 38 cm:
1x200 W (R7S 118 mm)
2x24 W (TC-L2G11)
- Quadratisch, 50 cm:
1x300 W (R7S 118 mm)
2x36 W (TC-L2G11)

OBERFLÄCHE

Chrom.

134

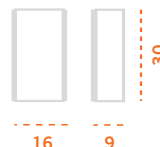
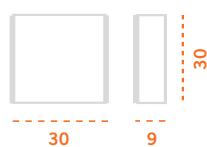
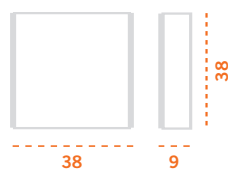
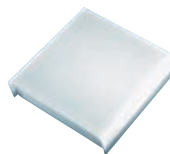
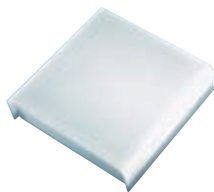
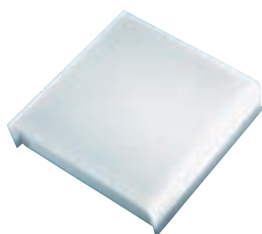



Aplique metálico halógeno.
BOMBILLAS
1x100 W máx. (R7S 80 mm)
ACABADOS
Plomo metalizado.

Metal halogen wall sconce.
BULBS
1x100 W max. (R7S 80 mm)
FINISHES
Metallic lead.

Wandleuchte aus Metall.
LAMPE
1x100 W max. (R7S 80 mm)
OBERFLÄCHE
Grau-metallic.



136

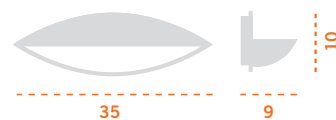

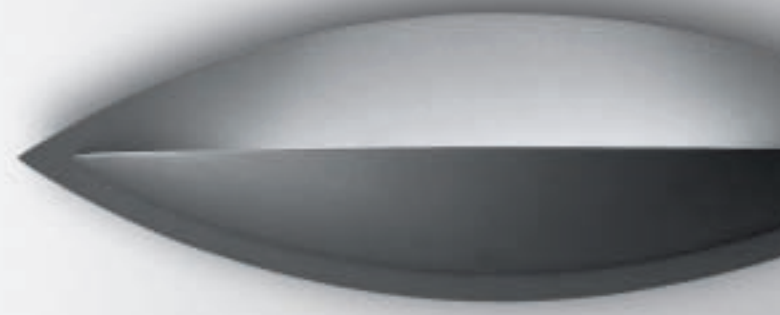

rondo

GABRIEL TEIXIDÓ

Plafón o aplique metálico en aluminio. Difusor de cristal matizado interiormente.

BOMBILLAS
1x75 W máx. (E-27)
2x7-9 W máx. (G23)

ACABADOS
Blanco y gris metalizado.

Metallic ceiling or wall lamp in aluminium. Glass diffuser with interior frosting.

BULBS
1x75 W max. (E-27)
2x7-9 W max. (G23)

FINISHES
White and metallic grey.

Wand- oder Deckenleuchte aus Aluminium. Mit innen mattiertem Glasschirm.

LAMPE
1x75 W max. (E-27)
2x7-9 W max. (G23)

OBERFLÄCHE
Weiß oder grau-metallic.



Apto exteriores, IP 54.
For outdoor use, IP 54.
Für Außenanwendung, IP 54.

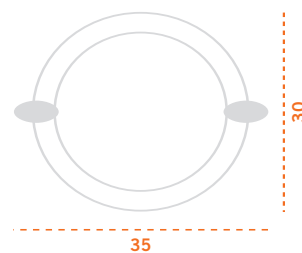



oval

GABRIEL TEIXIDÓ

Plafón o aplique metálico en aluminio. Difusor de cristal matizado interiormente.

BOMBILLAS
1x75 W máx. (E-27)
1x18 W máx. (G24 D2)

ACABADOS
Blanco y gris metalizado.

Metallic ceiling or wall lamp in aluminium. Glass diffuser with interior frosting.

BULBS
1x75 W max. (E-27)
1x18 W max. (G24 D2)

FINISHES
White and metallic grey.

Wand- oder Deckenleuchte aus Aluminium mit innen mattiertem Glasschirm.

LAMPE
1x75 W max. (E-27)
1x18 W max. (G24 D2)

OBERFLÄCHE
Weiß oder grau-metallic.



Apto exteriores, IP 54.
For outdoor use, IP 54.
Für Außenanwendung, IP 54.

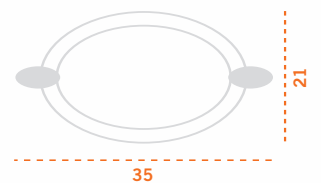



gallery

GABRIEL TEIXIDÓ

Conjunto de apliques para cuadros en dos tipos de pantalla reflectora A (ángulo recto), B (curvado).

BOMBILLAS (halógenas)
- 15 cm: 1x20 W máx. (G-4).
- 30 cm: 2x35 W máx. (G-4).
- 40 cm: 2x35 W máx. (G-4).

ACABADOS
Cromo y plomo metalizado.

Gallery A has a squared reflector.
Gallery B a curved reflector.

BULBS (halogen)
- 15 cm: 1x20 W max. (G-4).
- 30 cm: 2x35 W max. (G-4).
- 40 cm: 2x35 W max. (G-4).

FINISHES
Chrome and metallic lead.

Wandleuchte aus Metall mit rechtwinkligem oder gebogenem Reflektor für Bilder und Gemälde.

LAMPE
- 15 cm: 1x20 W max. (G-4)
- 30 cm: 2x35 W max. (G-4)
- 40 cm: 2x35 W max. (G-4)

OBERFLÄCHE
Chrom oder grau-metallic.

142

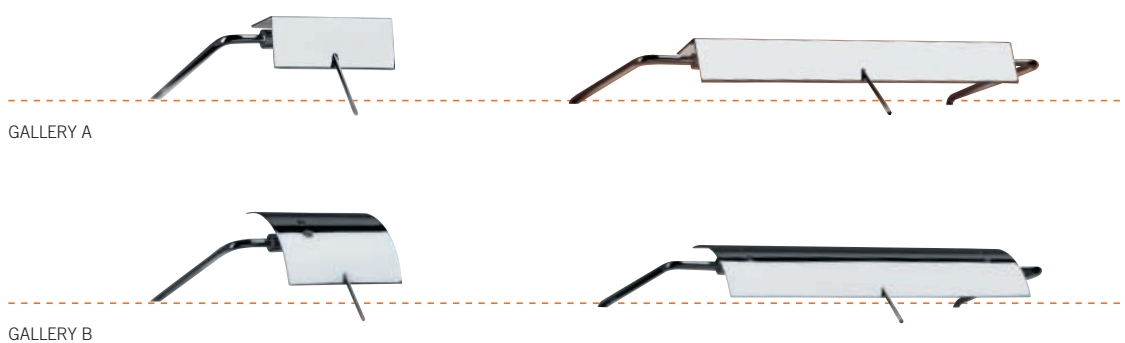

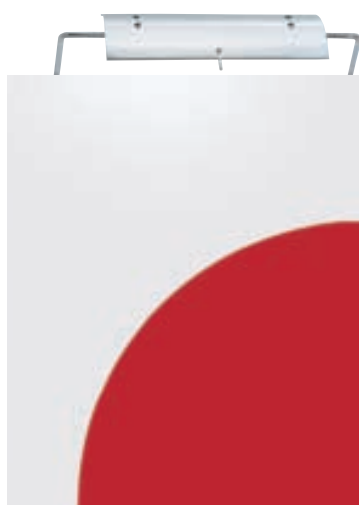
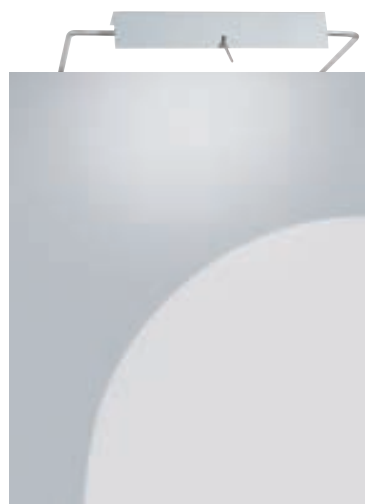
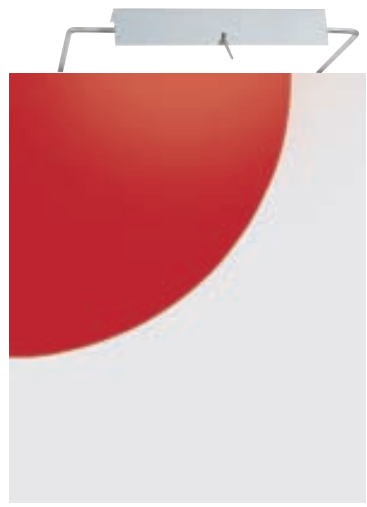
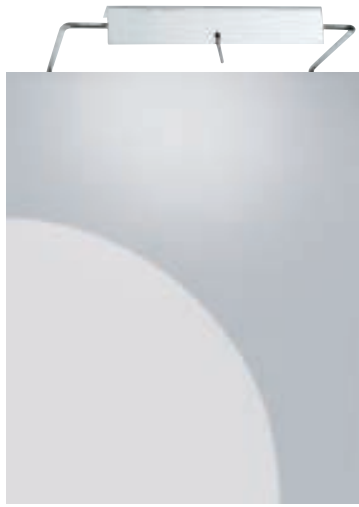

mondrian

DAIFUKU DESIGNS

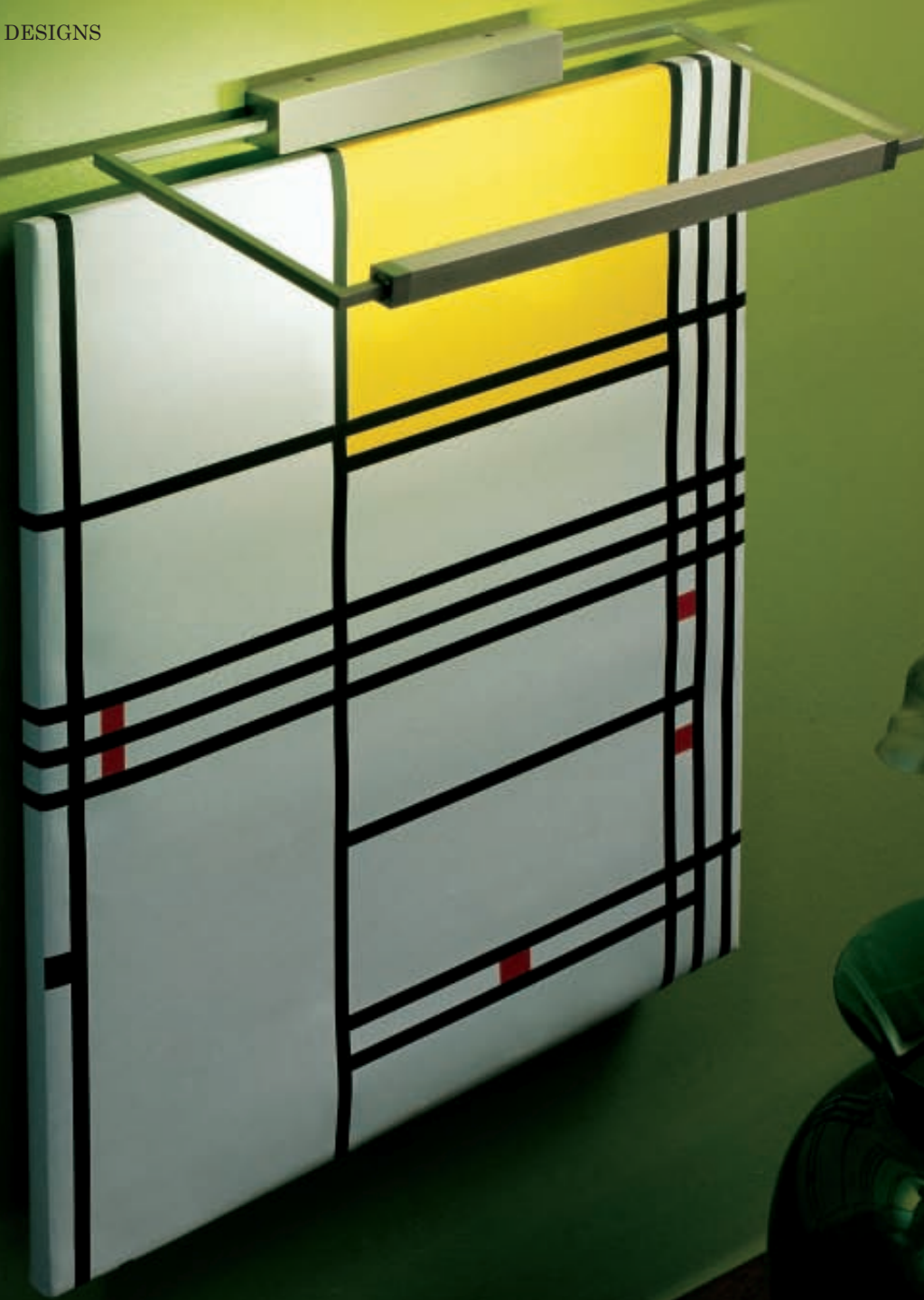

144

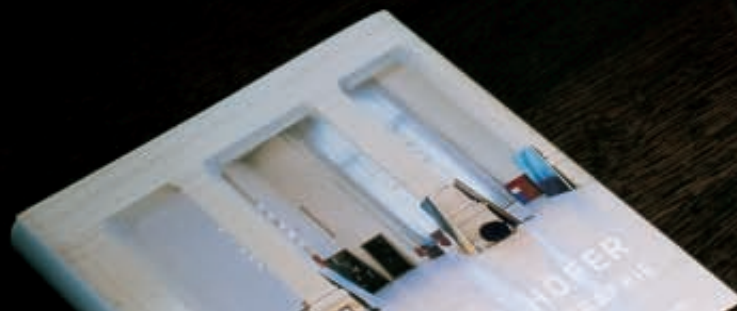

Aplique para iluminar cuadros,
reflector movible 340°.

BOMBILLAS

- 37 cm: 1x6 W máx.
(0,7 mm FM T2) Osram
- 47 cm: 1x8 W máx.
(0,7 mm FM T2) Osram
- 68 cm: 1x13 W máx.
(0,7 mm FM T2) Osram

ACABADOS

Níquel mate.

Family of picture-lamps, reflector
adjustable over 340°.

BULBS

- 37 cm: 1x6 W max.
(0,7 mm FM T2) Osram
- 47 cm: 1x8 W max.
(0,7 mm FM T2) Osram
- 68 cm: 1x13 W max.
(0,7 mm FM T2) Osram

FINISHES

Matt nickel.

Leuchte zur Anstrahlung von
Bildern, Reflektor 340° drehbar.

LAMPE

- 37 cm: 1x6 W max.
(0,7 mm FM T2) Osram
- 47 cm: 1x8 W max.
(0,7 mm FM T2) Osram
- 68 cm: 1x13 W max.
(0,7 mm FM T2) Osram

OBERFLÄCHE

Nickel matt.

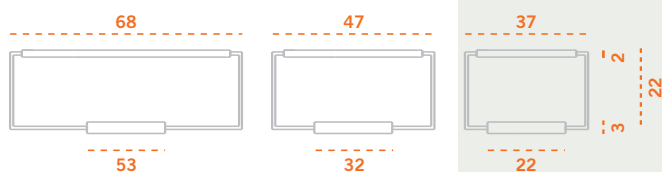
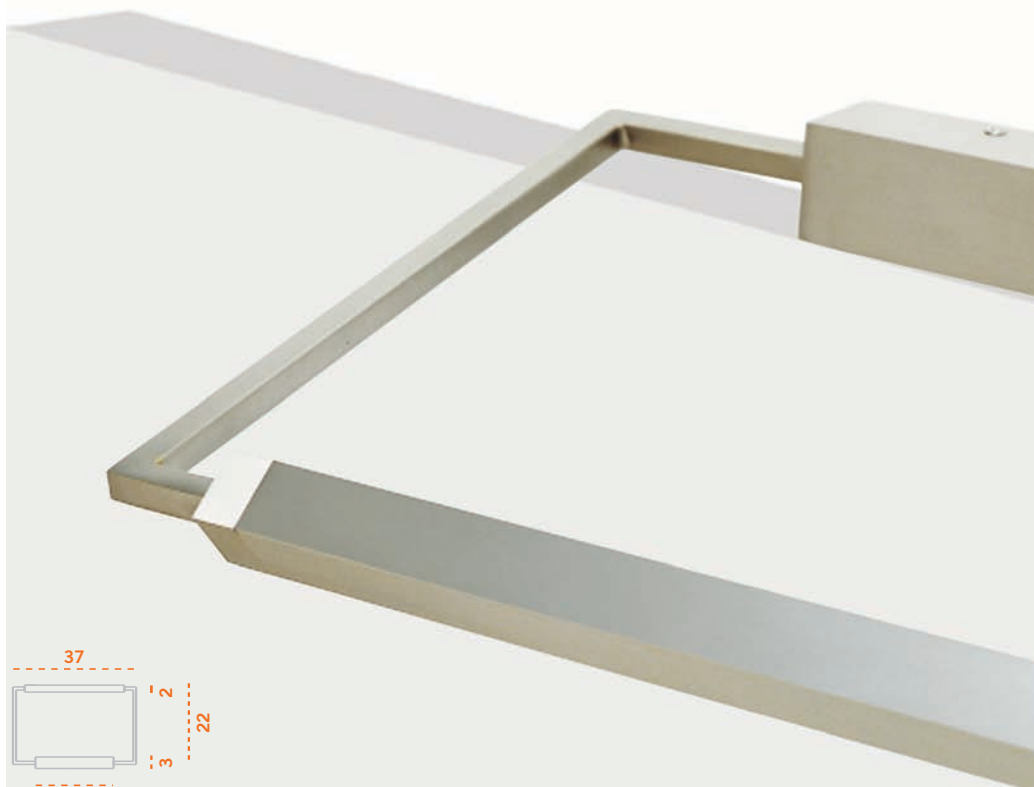
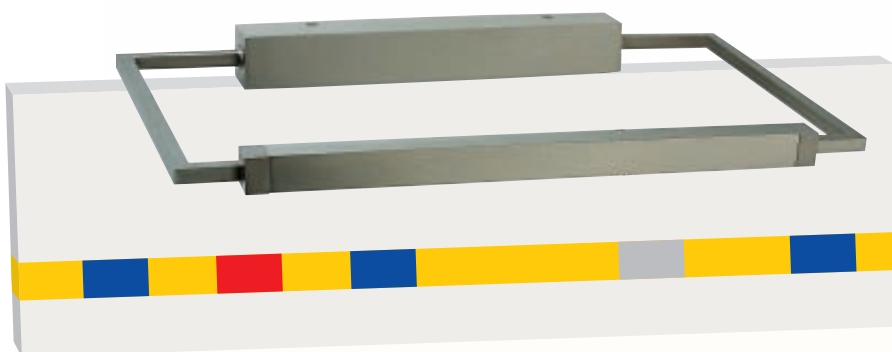

dial

GABRIEL TEIXIDÓ

Plafón o aplique de acero inoxidable con transformador incorporado. Se puede adaptar dos, tres o cuatro focos. Se fabrica en versión individual, de superficie o para empotrar en techo.

BOMBILLAS
QR111 12v 100 W máx.

ACABADOS
Acero inoxidable.

Wall or ceiling lamp with transformer in stainless steel for two, three or four lights. Also available as individual light or to embed in the ceiling.

BULBS
QR111 12v 100 W max.

FINISHES
Stainles steel.

Wand- oder Deckenleuchte aus Edelstahl mit integriertem elektronischem Transformator für zwei, drei oder vier Strahler. Auch als Einzelleuchte für Wandmontage, Deckeneinbau- oder Deckenanbau lieferbar.

LAMPE
QR111 12v 100 W max.

OBERFLÄCHE
Edelstahl.



146

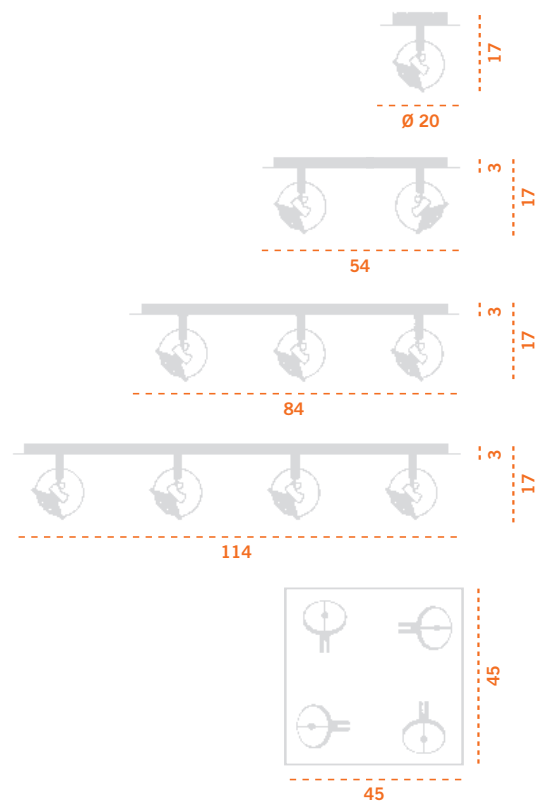



flash

GABRIEL TEIXIDÓ

148



Perfil de aluminio en el cual se pueden adaptar dos, tres o cuatro focos. Se fabrica en versión colgante y foco individual.

BOMBILLAS

Hi-Spot ES-63 75 W (GZ-10)

Hi-Spot ES-50 50 W (GZ-10)

ACABADOS

Plomo metalizado.

Aluminium track for two, three or four spotlight. Also available as pendant or individual light.

BULBS

Hi-Spot ES-63 75 W (GZ-10)

Hi-Spot ES-50 50 W (GZ-10)

FINISHES

Metallic lead.

Aluminium-Profil mit zwei, drei oder vier Strahlern. Auch als einzelne Kabel-Pendel-, Wand-, oder Deckenleuchte erhältlich.

LAMPE

Hi-Spot ES-63 75 W (GZ-10)

Hi-Spot ES-50 50 W (GZ-10)

OBERFLÄCHE

Grau-metallic.

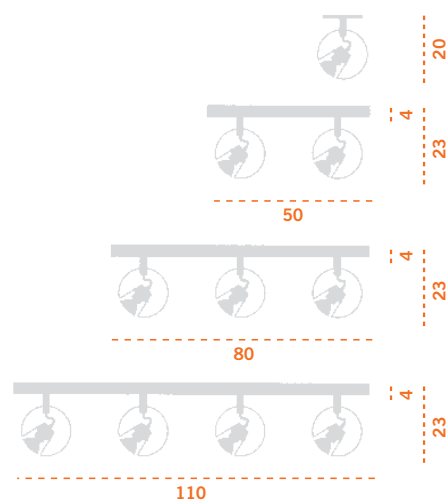
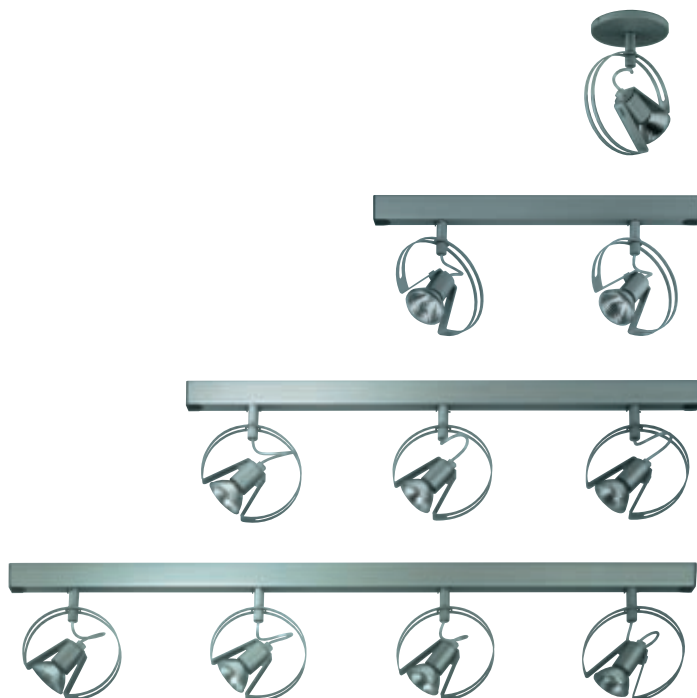

flash

GABRIEL TEIXIDÓ



150





focus, focus mini

GABRIEL TEIXIDÓ



Perfil de aluminio en el cual se pueden adaptar dos, tres o cuatro focos. Se fabrican en versión individual.

BOMBILLAS

- Focus Mini:
 - Hi-Spot ES-63 75 W (GZ-10)
 - Hi-Spot ES-50 50 W (GZ-10)
- Focus:
 - Hi-Spot 95 100 W máx. (E-27)
 - Concentra R80 100 W máx. (E-27)
 - Concentra R63 60 W máx. (E-27)

ACABADOS

Plomo metalizado.

Aluminium support which combines two, three or four spotlights. Also available as individual light.

BULBS

- Focus Mini:
 - Hi-Spot ES-63 75 W (GZ-10)
 - Hi-Spot ES-50 50 W (GZ-10)
- Focus:
 - Hi-Spot 95 100 W max. (E-27)
 - Concentra R80 100 W max. (E-27)
 - Concentra R63 60 W max. (E-27)

FINISHES

Metallic lead.

Aluminium-Profil für zwei, drei oder vier Strahler. Auch als Einzelleuchte erhältlich.

LAMPE

- Focus Mini:
 - Hi-Spot ES-63 75 W (GZ-10)
 - Hi-Spot ES-50 50 W (GZ-10)
- Focus:
 - Hi-Spot 95 100 W max. (E-27)
 - Concentra R80 100 W max. (E-27)
 - Concentra R63 60 W max. (E-27)

OBERFLÄCHE

Grau-metallic.

152

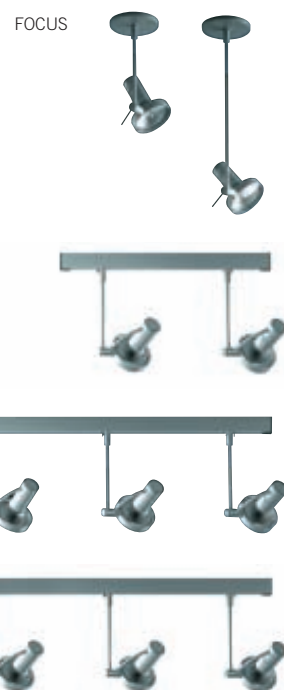



FOCUS MINI

FOCUS MINI

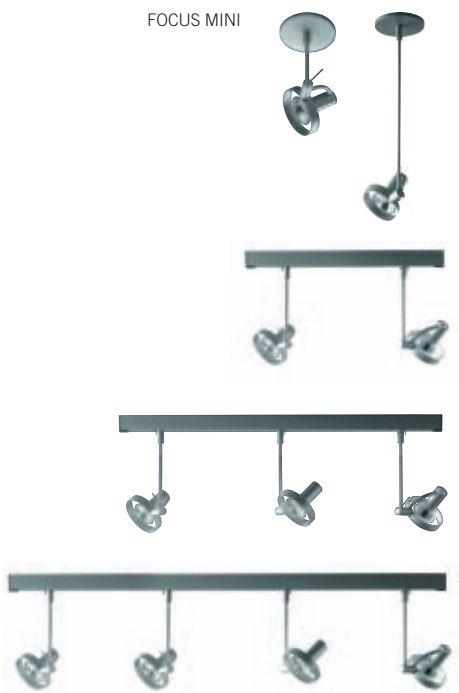

FOCUS , FOCUS MINI

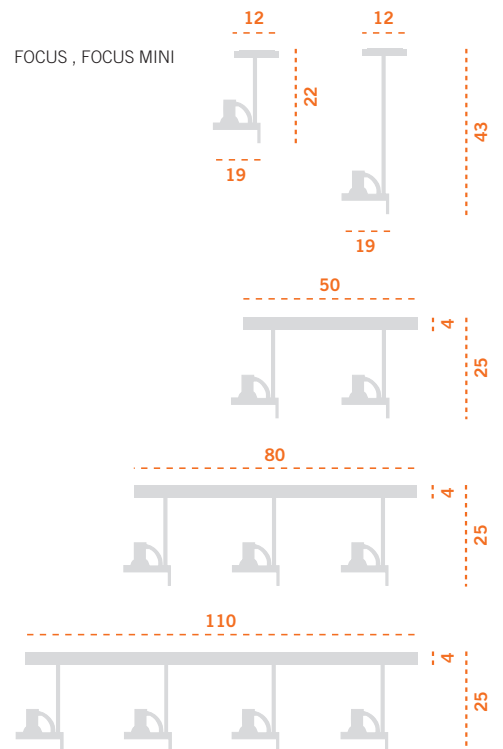



3

irma

NOVA +



Colgantes con pantalla metálica, disponible en dos medidas.

BOMBILLAS

- 25 cm: 1x60 W máx.
(E-27 Globe 60 mm)
- 40 cm: 1x100 W máx.
(E-27 Globe 80 mm)

ACABADOS

- Exterior: gris metalizado, blanco y negro.
- Interior: blanco o teja.

Suspension lamp with metallic lampshade available in two sizes.

BULBS (incandescent)

- 25 cm: 1x60 W max.
(E-27 Globe 60 mm)
- 40 cm: 1x100 W max.
(E-27 Globe 80 mm)

FINISHES

- Outside: metallic grey, white and black.
- Inside: white or brick.

Pendelleuchte mit Metallschirm in 2 verschiedenen Durchmessern.

LAMPE

- 25 cm: 1x60 W max.
(Globelampe 60 mm E27)
- 40 cm: 1x100 W max.
(Globelampe 80 mm E27)

OBERFLÄCHE

- Metallschirm außen: grau metallic, weiß oder schwarz.
- Metallschirm innen: weiß oder rotbraun.

156

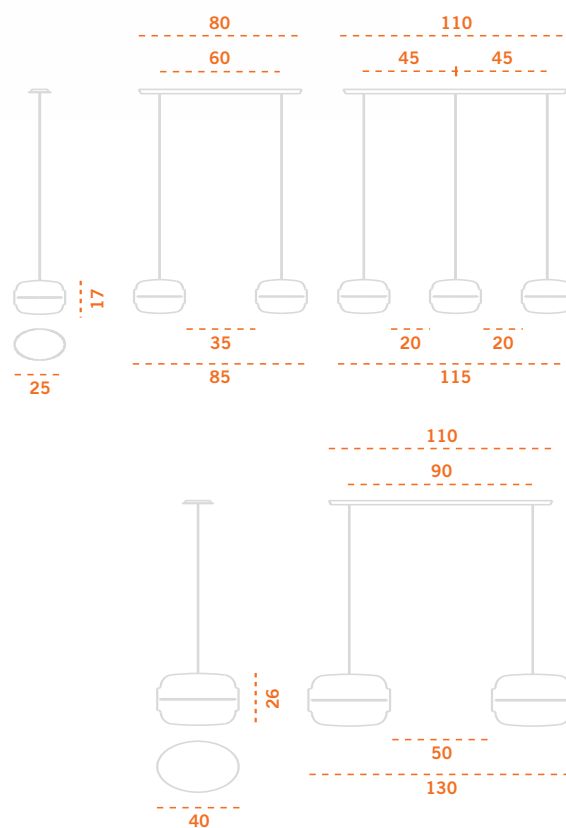



funi

PASCUAL SALVADOR

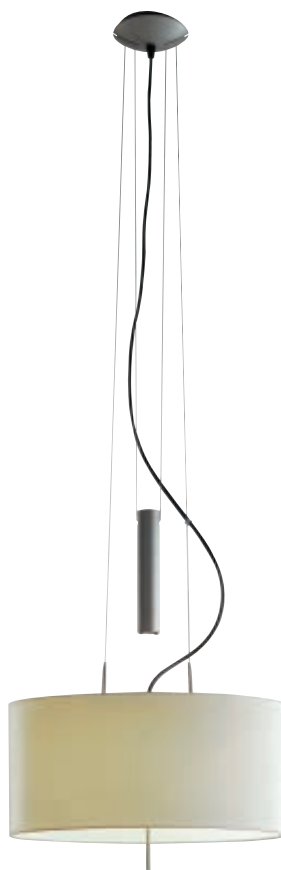

Colgante metálico que sube y baja, con pantalla ovalada de tela en algodón.

BOMBILLAS
2x100 W máx. (E-27)

ACABADOS
Plomo metalizado y oro metalizado.
Pantallas: blanca, beige.

Metallic pendant lamp with oval cotton shade which goes up and down.

BULBS
2x100 W max. (E-27)

FINISHES
Metallic lead and metallic gold.
Shades: white or beige.

Pendelleuchte aus Metall mit ovalem Baumwoll-Schirm, höhenverstellbar.

LAMPE
2x100 W max. (E-27)

OBERFLÄCHE
Grau-metallic oder gold-metallic.
Schirm: weiß oder beige.

158

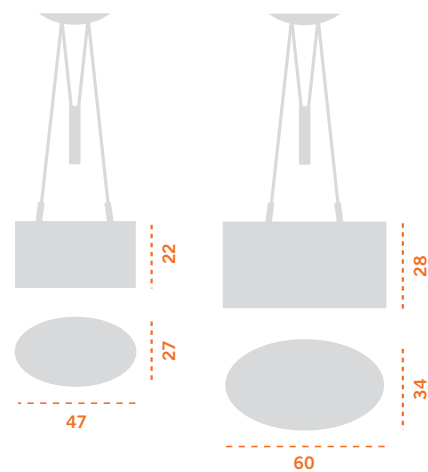



max

GABRIEL TEIXIDÓ

160



max

GABRIEL TEIXIDÓ

162

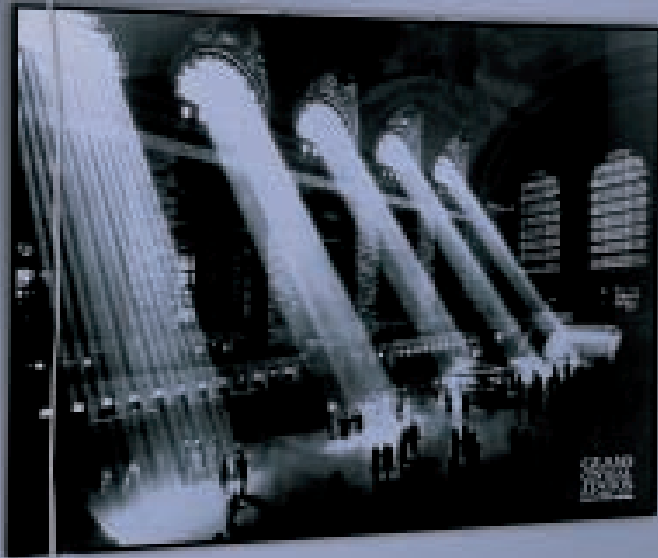

Colgante metálico de pared, brazo telescópico. Interruptor en el mismo portalámparas. Va equipada con un cable eléctrico de 5 m.

BOMBILLAS

1x150 W máx. (E-27)

ACABADOS

Metal: cromo.

Pantalla: ecológico, blanco, beige y negro.

Metallic pendant wall lamp, telescoped arm. Incorporated switch. Equipped with 5 m of wire.

BULBS

1x150 W max. (E-27)

FINISHES

Metal: chrome.

Shade: ecologic, white, beige and black.

Pendelleuchte mit Teleskoparm und eingebautem Schalter. Inklusive 5 Meter Kabel.

LAMPE

1x150 W max. (E-27)

OBERFLÄCHE

Metall: Chrom.

Schirm: natur, weiß, beige oder schwarz.

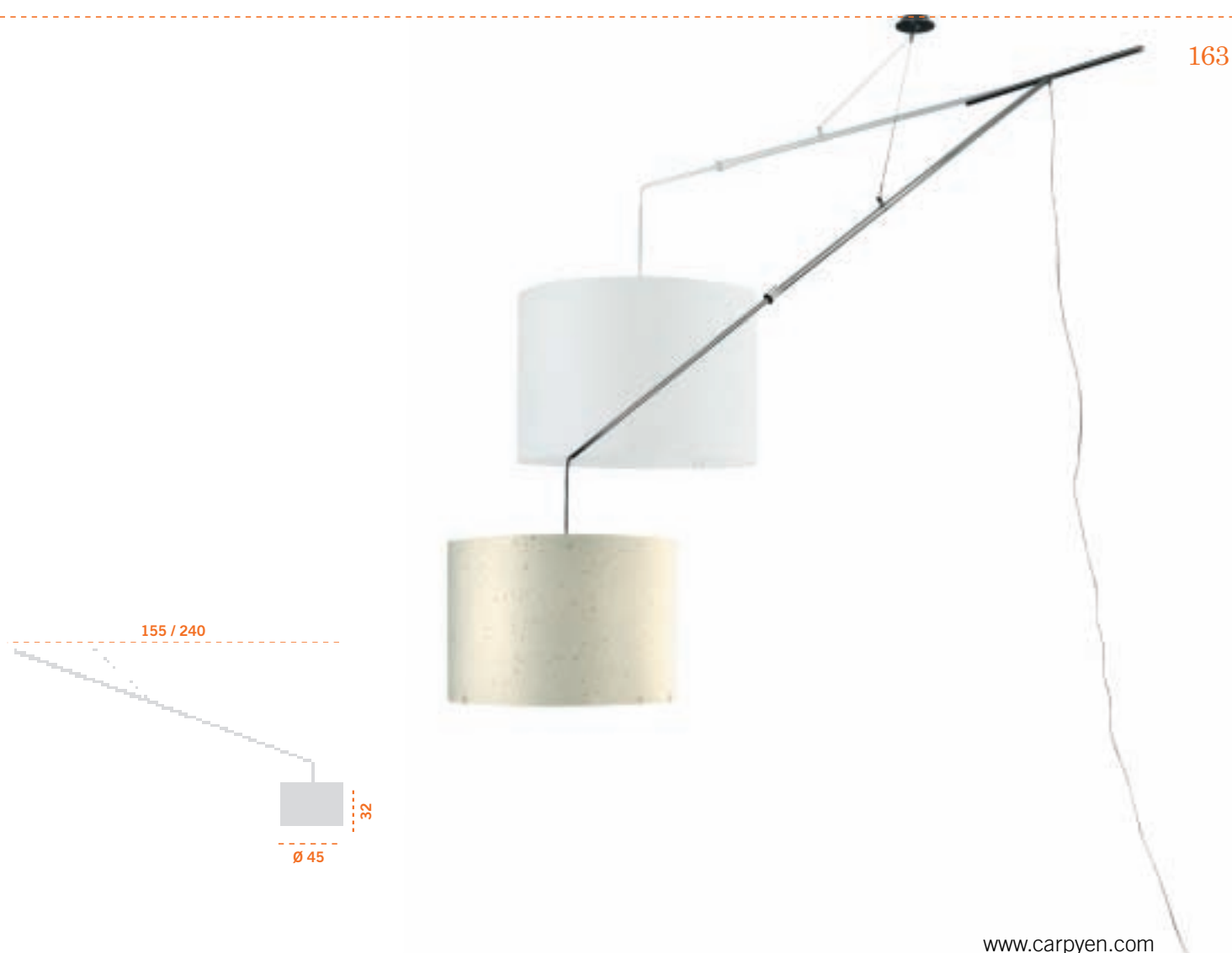

nick

Colgante: cristal prensado mate.

BOMBILLAS
1x100 W máx. (E-27)

ACABADOS
Plomo metalizado.

Pendant of striped frosted glass.

BULBS
1x100 W max. (E-27)

FINISHES
Metallic lead.

Pendelleuchte mit mattiertem,
relliertem Glasschirm.

LAMPE
1x100 W max. (E-27)

OBERFLÄCHE
Grau-metallic.



164

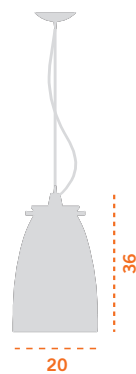



frida

GABRIEL TEIXIDÓ

Colgantes en cristal óptico, estructura metálica. Se fabrica en dos diámetros: Ø 57 cm y Ø 76 cm.

BOMBILLAS

- Ø 57 cm:
1x150 W máx. (B-15d)
- Ø 76 cm:
1x250 W máx. (E-27)

ACABADOS

Cromo.

Suspensión light with optical glass, metallic body. Available in two sizes: Ø 57 cm and Ø 76 cm.

BULBS

- Ø 57 cm:
1x150 W max. (B-15d)
- Ø 76 cm:
1x250 W max. (E-27)

FINISHES

Chrome.

Pendelleuchte mit satiniertem Glas, Gehäuse aus Chrom. In zwei Größen erhältlich: 57 und 76 cm.

LAMPE

- Ø 57 cm:
1x150 W max. (B-15d)
- Ø 76 cm:
1x250 W max. (E-27)

OBERFLÄCHE

Chrom.



166

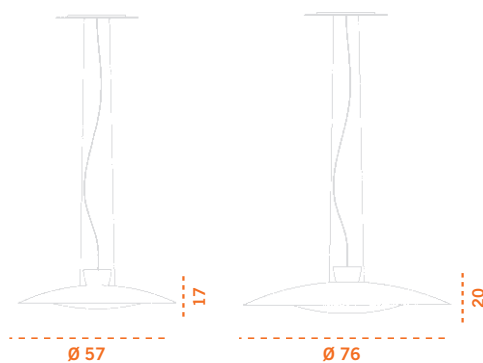
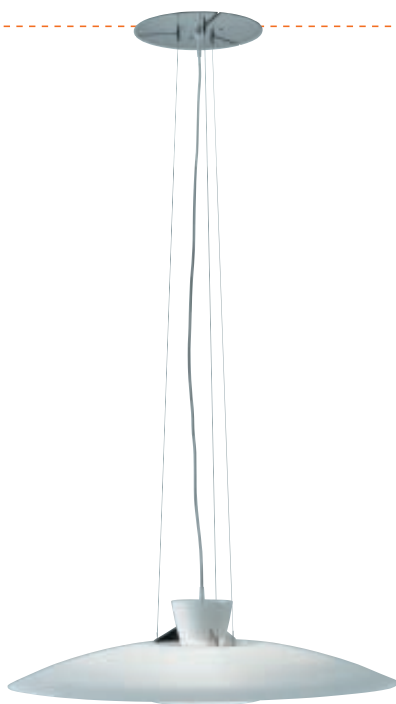



petra

JORDI MILÀ + JORDI TEIXIDÓ



168





Colgante metálico con cristal blanco.

BOMBILLAS
1x75 W máx. (E-27)

ACABADOS
Plomo metalizado.

Metallic hanging lamp with glass in white.

BULBS
1x75 W max. (E-27)

FINISHES
Metallic grey.

Pendelleuchte aus Metall mit weißem Glas.

LAMPE
1x75 W max. (E-27)

OBERFLÄCHE
Grau-metallic.



tommy

JORDI MILÀ (EDDA DESIGN)

Colgante metálico con cristal opal blanco.

BOMBILLAS
1x75 W máx. (E-27)

ACABADOS
Plomo metalizado y titanio.

Metallic pendant lamp with white opal glass.

BULBS
1x75 W max. (E-27)

FINISHES
Metallic lead and titanium.

Pendelleuchte aus Metall mit weißem Schirm aus Opalglas.

LAMPE
1x75 W max. (E-27)

OBERFLÄCHE
Grau-metallic oder titan.

170

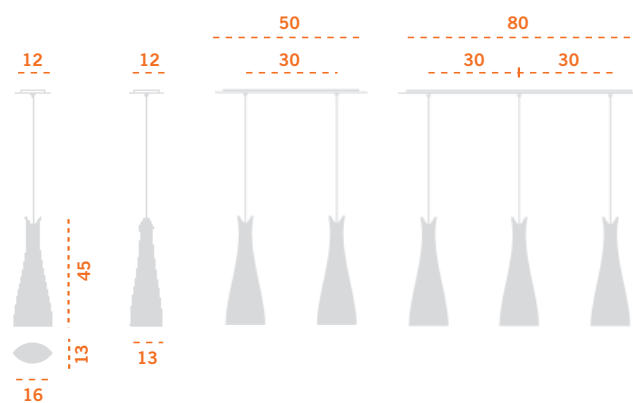



finger

PASCUAL SALVADOR



Colgante metálico con o sin brazo móvil. El brazo facilita la movilidad de la lámpara en un radio de 75 cm y tiene un ángulo de giro de 360°.

BOMBILLAS
2x100 W máx. (E-27)

ACABADOS
Plomo metalizado y oro metalizado.
Pantalla: blanca o beige.

Pendant lamp with or without moving arm. The moving arm allows the lamp to move in a radius of 75 cm and has an angle of turn of 360°.

BULBS
2x100 W max. (E-27)

FINISHES
Metallic lead or metallic gold.
Shades: white or beige.

Pendelleuchte mit oder ohne beweglichem Arm. Der bewegliche Arm erlaubt es, die Leuchte um 360° zu drehen und in einem Radius von 75 cm zu bewegen.

LAMPE
2x100 W max. (E27)

OBERFLÄCHE
Grau-metallic lead oder gold-metallic.
Schirm: weiß oder beige.

172

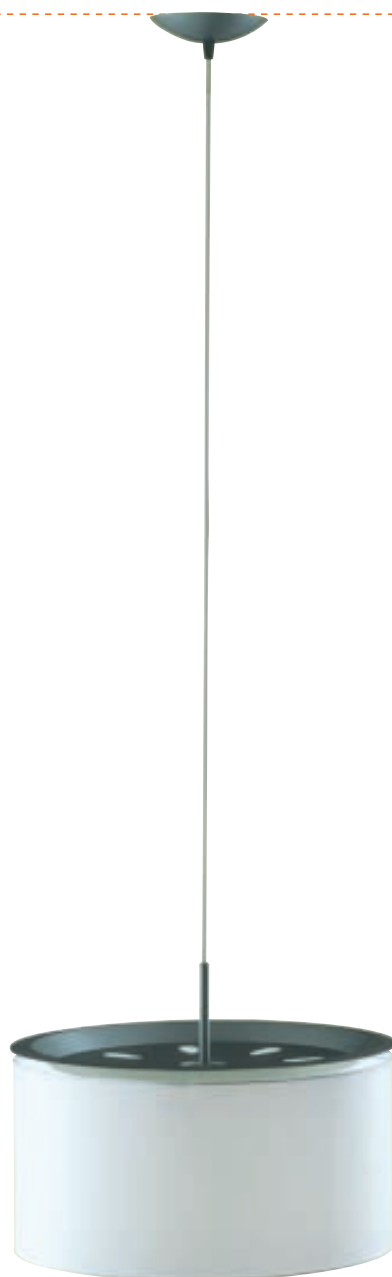
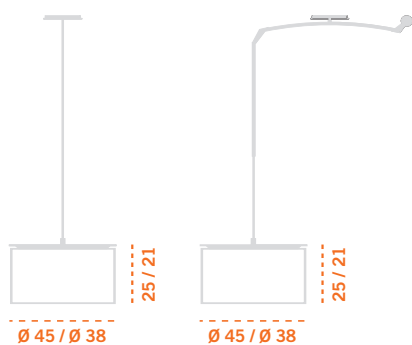



metropol



Ventilador con luz. Equipado con mando a distancia.

Importante: altura mínima de la aspa al suelo 230 cm.

BOMBILLAS
1x150 W máx. (R7S 80 mm)

POTENCIA MOTOR
75 W - 230 V

ACABADOS
Estructura y aspas: metal pintado en plomo metalizado.

Tapa motor en perspex, colores: transparente, rojo, naranja, azul y amarillo.

Ceiling fan with light. Equipped with remote control.

Attention: minimum height distance between the blade and the floor 230 cm.

BULBS
1x150 W max. (R7S 80 mm)

POWER MOTOR
75 W - 230 V

FINISHES
Structure and blades: metal painted in metallic lead.
Motor cover in perspex, colors: transparent, red, orange, blue and yellow.

Deckenventilator mit integrierter Leuchte inkl. Fernbedienung.
Achtung: Minimaler Abstand zwischen Boden und Unterkante Ventilator = 230 cm.

LAMPE
1x150 W max. (R7S 80 mm)

MOTORLEISTUNG
75 W - 230 V

OBERFLÄCHE
Gehäuse und Rotorblätter: Metall, grau-metallisch lackiert.
Motorgehäuse aus Kunststoff, Farben: transparent, rot, orange, blau oder gelb.

174

VENTAJAS DEL VENTILADOR

- Refresca en los meses de calor.
- Facilita una rápida eliminación de olores desagradables y humo.
- En invierno permite una utilización más racional de la calefacción: seleccionando la velocidad mínima, el aparato envía hacia abajo el aire caliente concentrado en el techo manteniendo una temperatura constante.

ADVANTAGES OF A FAN UNIT

- To cool the room during summer months.
- To facilitate rapid elimination of unpleasant smells and smoke.
- To allow in winter a more rational use of the heating system: if left to turn at a minimum speed, it will actually bring the hot air that concentrates towards the ceiling back down into the room, thus maintaining a more even constant temperature at floor level.

VORTEILE EINES VENTILATORS

- Kühlt den Raum während der Sommermonate.
- Vertreibt Rauch und unangenehme Gerüche.
- Unterstützt im Winter eine optimale Ausnutzung der Heizung. Bei kleiner Umdrehung wird die warme Luft von der Decke wieder in den Raum zurück transportiert und bewirkt so eine konstantere Raumtemperatur.

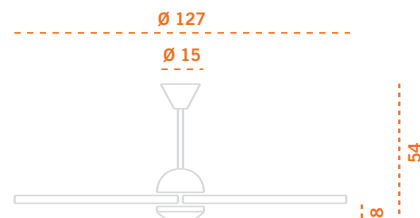



tema

GABRIEL TEIXIDÓ

Pie suelo y sobremesa metálico halógeno. Lámparas orientables en todos los sentidos.

BOMBILLAS
1x12V 50W máx. (M-32)

ACABADOS
Titanio, plomo metalizado, oro metalizado, cromo y negro.

Metallic halogen floor and table lamp. Adjustable in all directions.

BULBS
1x12V 50W max. (M-32)

FINISHES
Chrome, black, metallic lead, metallic gold and titanium.

Dreh- und schwenkbare Stehleuchte aus Metall. Auch als Tischleuchte erhältlich.

LAMPE
1x12V 50W max. (M-32)

OBERFLÄCHE
Titan, grau-metallic, gold-metallic, chrom oder schwarz.

176

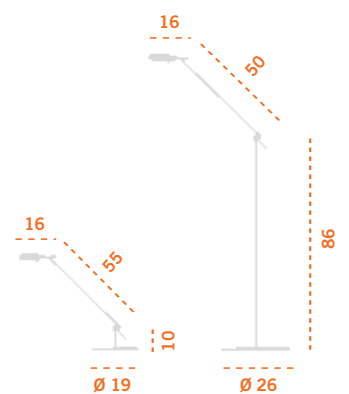



douglas

GABRIEL TEIXIDÓ

178



Lámpara articulada con uno o dos brazos. Accesorios: base mesa, pinza, soporte pared y pie.

BOMBILLAS
1x75 W máx. (E-27)

ACABADOS
Plomo metalizado.

Articulated lamp with one or two arms. Accessories: table base, clamp, wall set and floor base.

BULBS
1x75 W max. (E-27)

FINISHES
Metallic lead.

Tischleuchte mit einem oder zwei verstellbaren Armen. Auch als Steh- oder Klemmleuchte.

LAMPE
1x75 W max. (E-27)

OBERFLÄCHE
Grau-metallic.



179

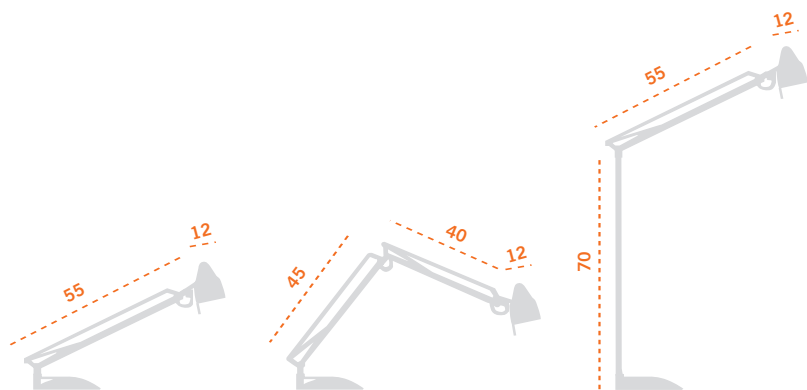

ACCESORIOS
ACCESORIES
ZUBEHÖR



aladina

GABRIEL TEIXIDÓ

Lámpara articulada con uno o dos brazos. Accesorios: base mesa, pinza, soporte pared y pie.

BOMBILLAS
1x75 W máx. (G9) Halógena.

ACABADOS
Negro y plomo metalizado.

Articulated lamp with one or two arms. Accessories: table base, clamp, wall set and floor base.

BULBS
1x75 W max. (G9) Halogen.

FINISHES
Black and metallic lead.

Tischleuchte mit einem oder zwei dreh- und schwenkbaren Armen. Auch als Stehleuchte.

LAMPE
1x75 W max. (G9) Halogen.

OBERFLÄCHE
Schwarz oder grau-metallic.

180



ACCESORIOS
ACCESORIES
ZUBEHÖR



Base sobremesa
Table base
Tischleuchte



Pinza
Clamp
Klemme



Soporte pared
Wall set
Wandleuchte



Pie
Floor base
Sthleuchte

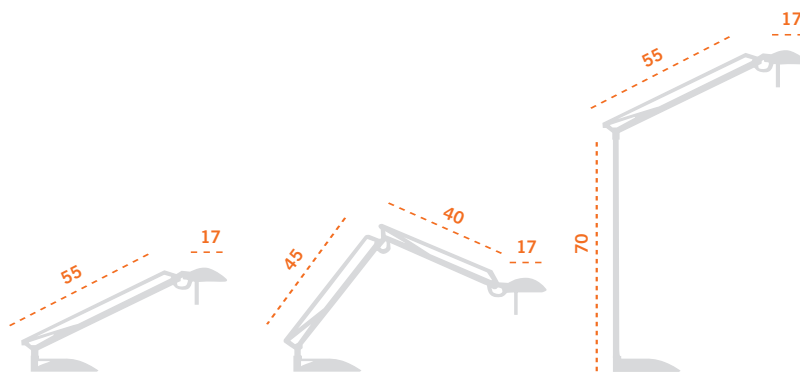



master

GABRIEL TEIXIDÓ

Lámpara sobremesa halógena
metálica con pantalla orientable.

BOMBILLAS
1x12V 50W máx. (M-32)

ACABADOS
Negro y cromo.

Adjustable metal table lamp.

BULBS
1x12V 50W max. (M-32)

FINISHES
Black or chrome.

Tischleuchte mit verstellbarem
Schirm.

LAMPE
1x12V 50W max. (M-32)

OBERFLÄCHE
Schwarz oder chrom.

182







Sobremesa metálica con pantalla de cristal opal. Se fabrica en dos medidas.

BOMBILLAS

- Grande: 1x100 W máx. (E-27)
- Pequeña: 1x60 W máx. (E-14)

ACABADOS

Cromo, plomo metalizado y oro metalizado.

Opal glass table lamp with metal frame. Available in two sizes.

BULBS

- Large: 1x100 W max. (E-27)
- Small: 1x60 W max. (E-14)

FINISHES

Chrome, metallic lead and metallic gold.

Tischleuchte aus Metall mit opal-weißem Glasschirm. In zwei Größen erhältlich.

LAMPE

- Groß: 1x100 W max. (E-27)
- Klein: 1x60 W max. (E-14)

OBERFLÄCHE

Chrom, grau-metallic oder gold-metallic.

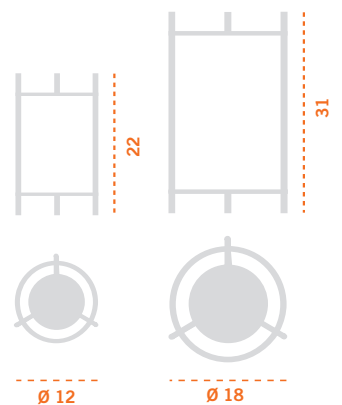



nairobi

GABRIEL TEIXIDÓ

Lámpara sobremesa metálica con pantalla en algodón, diseñada para espacios rectangulares o cuadrados.

BOMBILLAS
1x100 W máx. (E-27)

ACABADOS
Níquel mate.
Pantalla: blanca, beige y negra.

Metallic table lamp with cotton shade. Designed for square and rectangular spaces.

BULBS
1x100 W max. (E-27)

FINISHES
Matt nickel.
Shade: White, beige and black.

Tischleuchte mit Baumwollschirm.

LAMPE
1x100 W max. (E-27)

OBERFLÄCHE
Níquel matt .
Schirm: weiß, beige oder schwarz.

186

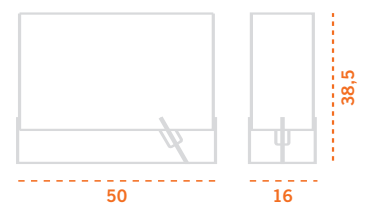



pocket

NAHTRANG DISSENY

Lámpara sobremesa, diseñada para ambientes juveniles.

BOMBILLAS
1x40 W máx. (E-14)

ACABADOS
Plomo metalizado.
Plástico: blanco, naranja, verde y rojo.

Table lamp for young ambients.

BULBS
1x40 W max. (E-14)

FINISHES
Metallic lead.
Acrylic in white, orange, green and red.

Tischleuchte mit Schirm aus Kunststoff speziell für Kinderzimmer entwickelt.

LAMPE
1x40 W max. (E-14)

OBERFLÄCHE
Grau-metallic .
Kunststoff: weiß, orange, grün oder rot.

188

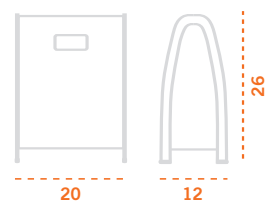



pascualina

PASCUAL SALVADOR

Lámpara pinza metálica con pantalla. Equipada con un cable de 3 m e interruptor en la base. Pinza adaptable hasta 35 mm de grueso. Se fabrica en aplique con interruptor en la base.

BOMBILLAS
1x60 W máx. (E-14)

ACABADOS
Titanio, plomo metalizado y oro metalizado.
Pantallas: blanca o beige en algodón.

Clip-on and wall lamp with direct and diffused light. Equipped with 3 m of wire and switch on the base itself. Clip can be fit up to 35 mm in thickness. Also available as wall lamp with switch on the base.

BULBS
1x60 W max. (E-14)

FINISHES
Metallic lead, metallic gold and titanium.
Shades: cotton fabric in white or beige.

Klemmleuchte aus Metall mit Schirm. Mit drei Meter Kabel und Schalter am Fuß. Klemme lässt sich bis 35 mm Materialstärke montieren. Auch als Wandleuchte mit Schalter am Fuß erhältlich.

LAMPE
1x60 W max. (E-14)

OBERFLÄCHE
Titan, grau-metallic oder gold-metallic.
Schirm aus Baumwolle: weiß oder beige glatt.

190

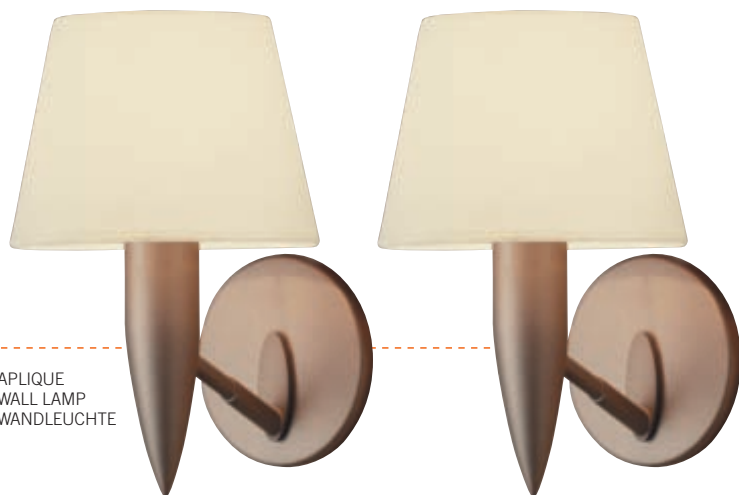

APLIQUE
WALL LAMP
WANDLEUCHTE

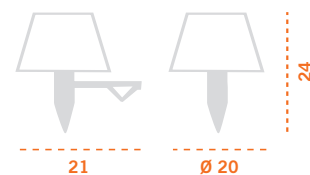



Lámpara pinza con interruptor incorporado; muy adecuado para iluminar estanterías, tanto directa como indirectamente. Va equipada con un cable de 3 m. Pinza adaptable hasta 35 mm de grueso.

BOMBILLAS
Fluorescente 11 W máx. (Ø 7mm FM T2) Osram

ACABADOS
Plomo metalizado y titanio.

Clip-on lamp, equipped with on-off switch and 3 m of wire. Clip can open up to 35 mm in thickness. Direct and indirect light.

BULBS
Fluorescent 11 W max. (Ø 7mm FM T2) Osram

FINISHES
Metallic lead and titanium.

Klemmleuchte mit integriertem Schalter. Einfache Montage. Inklusive 3 Meter Kabel. Klemme läßt sich bis 35mm Materialstärke montieren.

LAMPE
11 W max. (Ø 7mm FM T2) Osram

OBERFLÄCHE
Grau-metallic oder titan.

192

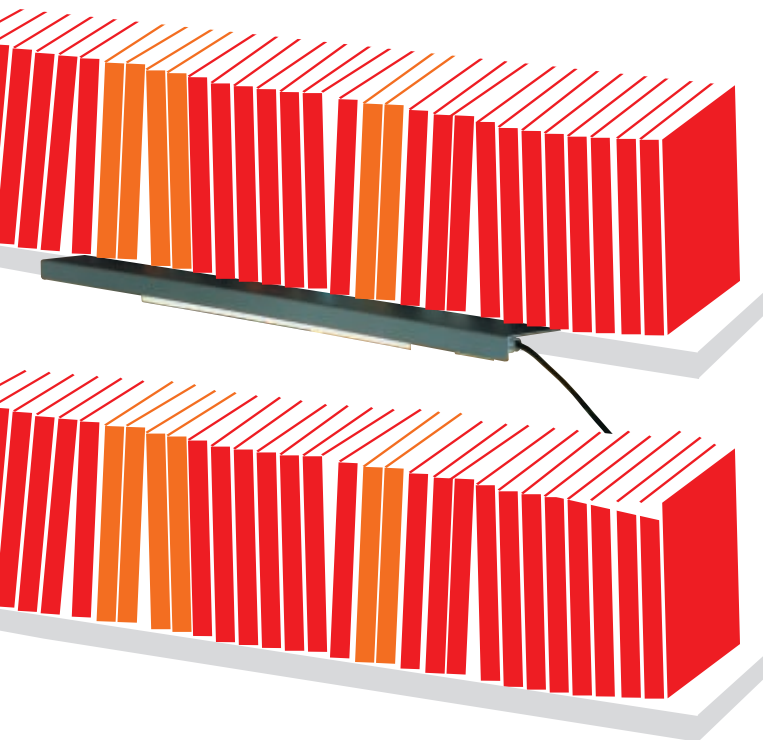

hi-fi

GABRIEL TEIXIDÓ

Lámpara pinza con interruptor incorporado. Luz halógena. Pantalla orientable 360°. Se caracteriza por su comodidad de manejo al estar equipada con un cable de 3 m. Pinza adaptable hasta 35 mm de grueso.

BOMBILLAS
2x20 W máx. (G-4)

ACABADOS
Acero inoxidable.

Clip-on lamp with incorporated switch. Halogen light. Shade orientated at 360°. Very easy to handle, equipped with 3 m of wire. Clip can open to 35 mm in thickness.

BULBS
2x20 W max. (G-4)

FINISHES
Stainless steel.

Klemmleuchte mit integriertem Schalter. Lampenschirm vertikal schwenkbar. Einfache Montage. Inklusive 3 Meter Kabel. Klemme lässt sich bis 35 mm Materialstärke montieren.

LAMPE
2x20 W max. (G-4)

OBERFLÄCHE
Edelstahl.



DELTA DE PLATA 1997
ADI-FAD





carla

GABRIEL TEIXIDÓ

Lámpara-mesa en metal.

BOMBILLAS
1x100 W máx. (E-27)

ACABADOS
Plomo metalizado y gris antracita.
Maderas: bubinga, peral, roble,
cerezo y wengué.
Pantalla policarbonato, puede
variar de altura.

Metallic table lamp.

BULBS
1x100 W max. (E-27)

FINISHES
Metal anthracite grey or metallic
lead.
Wood: bubinga, pearwood, oak,
cherry-wood or wenge.
Diffuser in polycarbonate with
height adjustment.

Stehleuchte aus Metall.

LAMPE
1x100 W max. (E-27)

OBERFLÄCHE
Metall anthrazit oder grau-metallic.
Holz: bubinga, Birne, Eiche,
Kirsche oder Wenge.
Schirm: höhenverstellbar aus
Polycarbonat.

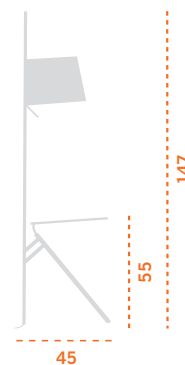



augusta

GABRIEL TEIXIDÓ

Pie suelo halógeno con dimmer.
Se caracteriza por tener su base y reflector en cristal mate. Todas las partes metálicas son de aluminio.

BOMBILLAS
1x250 W máx. (B-15d)

ACABADOS ANODIZADOS
Aluminio pulido y negro brillante.

Metal halogen, floor lamp with dimmer. The base and diffuser are in opaque glass.

BULBS
1x250 W max. (B-15d)

ANODIZED FINISHES
Polished aluminium and bright black.

Stehleuchte mit Dimmer.
Leuchtenfuß und Schirm aus mattiertem Glas. Alle Metallteile sind aus Aluminium.

LAMPE
1x250 W max. (B-15d)

OBERFLÄCHE
Poliertes Aluminium oder schwarz glänzend.

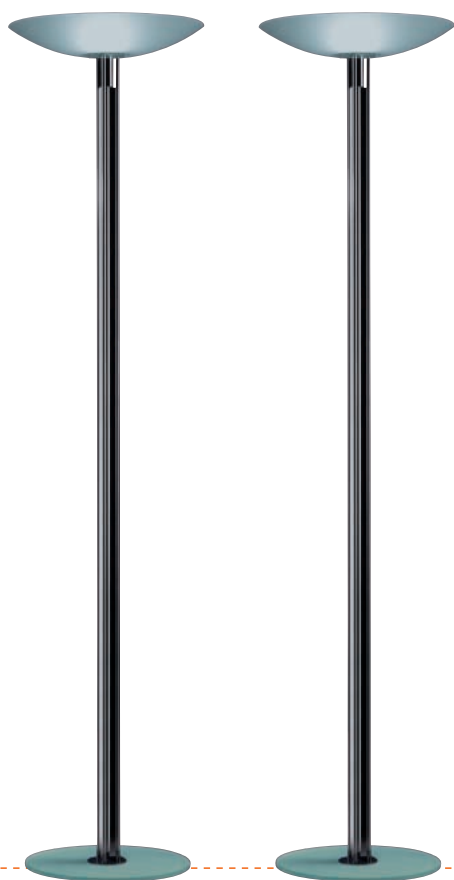



cónica

GABRIEL TEIXIDÓ

Pie suelo halógeno con cristal opal
blanco equipado con dimmer.

BOMBILLAS
1x150 W máx. (B15d)

ACABADOS
Cromo y plomo metalizado.

Metal, halogen, floor lamp with
white opal diffuser. Equipped with
dimmer.

BULBS
1x150 W max. (B15d)

FINISHES
Chrome and metallic lead.

Stehleuchte aus Metall mit weißem
Opalglas und Dimmer.

LAMPE
1x150 W max. (B15d)

OBERFLÄCHE
Chrom oder grau-metallic.

200





barcino

GABRIEL TEIXIDÓ

Pie suelo y aplique metálico halógeno. El reflector del pie de suelo gira 180° y está equipado con dimmer.

BOMBILLAS
1x300 W máx. (R7S 118 mm)

ACABADOS
Cromo, negro, titanio y plomo metalizado.

Metallic floor and wall lamp. The floor lamp reflector rotates 180° and equipped with dimmer.

BULBS
1x300 W max. (R7S 118 mm)

FINISHES
Chrome, black, metallic lead and titanium.

Wand- und Stehleuchte mit Gehäuse aus Metall.

LAMPE
1x300 W max. (R7S 118 mm)

OBERFLÄCHE
Chrom, schwarz, titan oder grau-metallic.

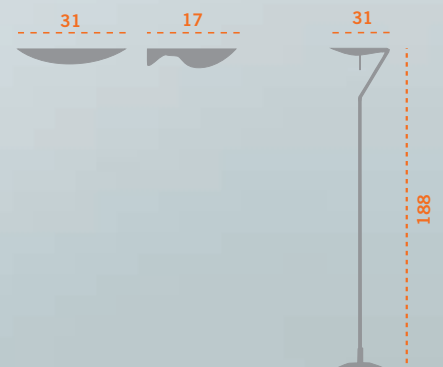

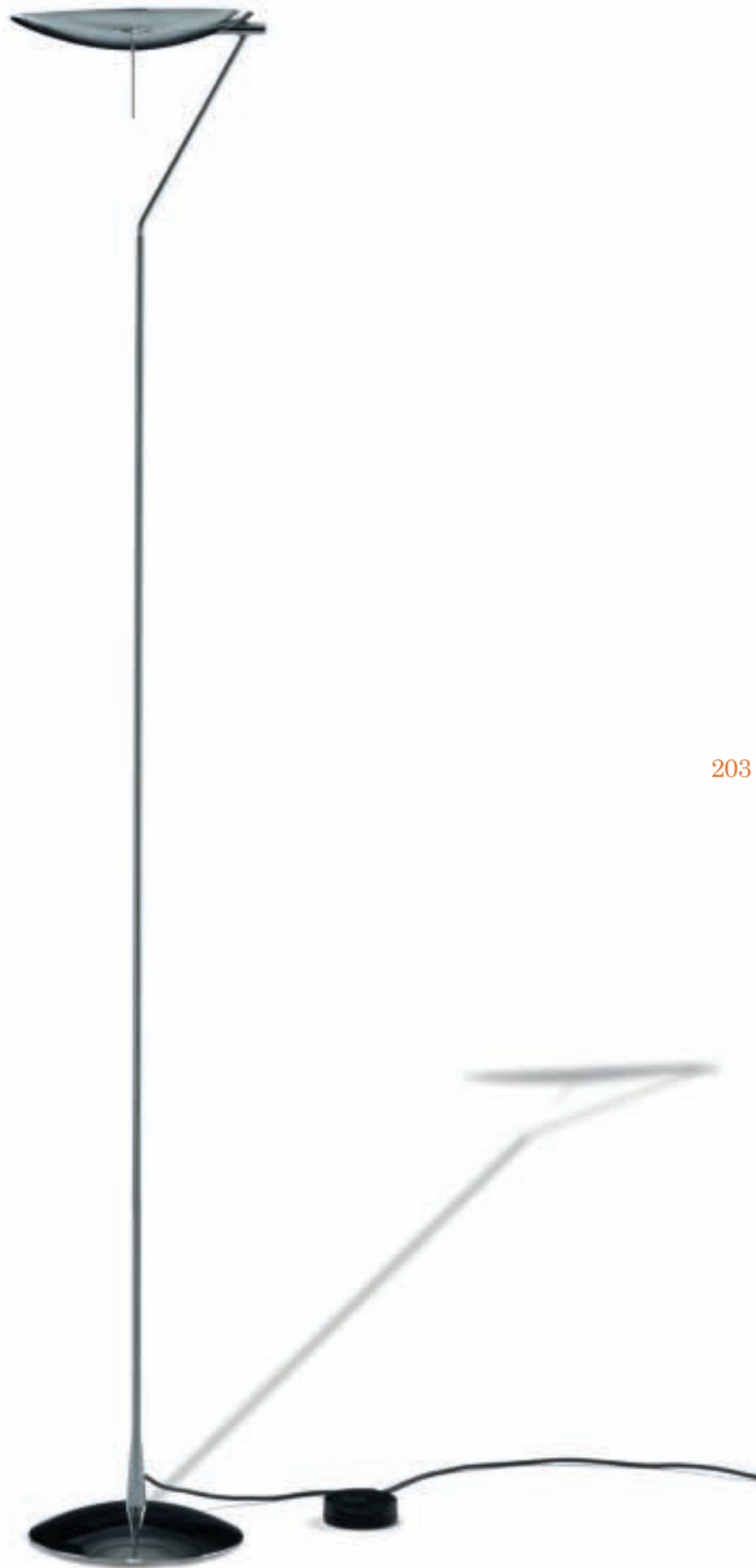

atenea

GABRIEL TEIXIDÓ

Pie suelo halógeno metálico,
equipado con dimmer.

BOMBILLAS
1x500 W máx. (R7S 118 mm)

ACABADOS
Cromo, negro, titanio y plomo
metalizado.

Metal halogen, floor lamp with
dimmer.

BULBS
1x500 W max. (R7S 118 mm)

FINISHES
Chrome, black, metallic lead and
titanium.

Stehleuchte aus Metall mit Dimmer.

LAMPE
1x500 W max. (R7S 118 mm)

OBERFLÄCHE
Chrom, schwarz, titan oder grau-
metallic.

204





omara

DAIFUKU DESIGNS

Lámpara pie suelo de grandes dimensiones apto para lugares donde se necesita ahorrar energía. Está fabricada en cristal opal blanco y fibra poliéster, cumpliendo la norma UNE23727 (M1). Incorpora en el centro un pulsador-interruptor que actúa como dimmer.

BOMBILLAS
1x57 W máx.
(GX24Q-5 bajo consumo)

ACABADOS
Negro antracita y nácar blanco.

Floor lamp of big dimensions conceived for spaces where energy saving is important. Made with white opal glass and polyester fibre complying the regulation UNE 23727 (M1). In the centre it features a push button on/off switch which acts also as a dimmer.

BULBS
1x57 W max.
(GX24Q-5 low energy)

FINISHES
Black anthracite and white nacre.

Stehleuchte zum Einsatz in Bereichen mit Energieeinsparungsanforderungen. Mit Glas opalweiß und Polyester (feuerhemmend UNE 23727 / M1) und Zugschalter mit Dimmfunktion.

LAMPE
1x57 W max.
(GX24Q-5 Kompaktleuchtstofflampe)

OBERFLÄCHE
Schwarz anthrazit oder perlmutt weiß.







4

candel

DAIFUKU DESIGNS



210

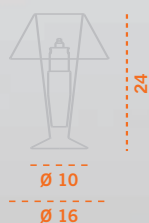

Es una lámpara autónoma para acompañar cenas en casa o restaurantes. Consta de dos piezas, un cuerpo de pirex soplado a mano y un cartucho estanco con aceite mineral inodoro de usar y tirar (40 horas de uso).

CARTUCHO
Ksi Type 50 SE

The perfect lamp to create an intimate atmosphere for dinners at home or in restaurants. It deals with a genuine piece of art as it is handmade. The lamp is made up of one single compact pyrex glassblown body which contains a waterproof refill of mineral oil. The refill is totally odourless and easy to replace (40 hours lifespan).

REFILL
Ksi Type 50 SE

Ein Leuchter für stil-und stimmungsvolle Beleuchtung in Haus oder Garten aus in Handarbeit gefertigtem Pirex-Glas. Eine wasserdichte Kartusche mit geruchlos brennendem Mineralöl für eine Brenndauer von bis zu 40 Stunden gehört zum Lieferumfang.

KARTUSCHE
Ksi Typ 50 SE

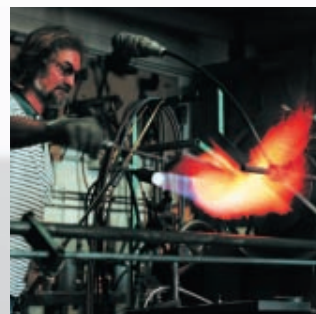

Fabricación artesanal.
Hand-made.
In Handarbeit hergestellt.



poppy

DAIFUKU DESIGNS

Es una lámpara autónoma para acompañar cenas en casa o restaurantes. Consta de un cuerpo en aluminio inyectado y un reflector en cristal pirex. Incorpora un cartucho estanco con aceite mineral inodoro de usar y tirar (40 horas de uso).

CARTUCHO
Ksi Type 50 SE

ACABADOS
Cromo y negro antracita.

The perfect light to create an intimate atmosphere for dinners at home or in restaurants. Made of an injected aluminium body and pyrex glass reflector. The body contains a waterproof refill of mineral oil. The refill is totally odourless, disposable and easy to replace (40 hours lifespan).

REFILL
Ksi Type 50 SE

FINISHES
Chrome and anthracite black.

Ein Leuchter für stil- und stimmungsvolle Beleuchtung in Haus, Garten oder Restaurants aus Aluminium und Reflektor aus Pyrex-Glas. Eine wasserdichte Kartusche mit geruchlos brennendem Mineralöl für eine Brenndauer von bis zu 40 Stunden gehört zum Lieferumfang.

KARTUSCHE
Ksi Typ 50 SE

OBERFLÄCHE
Chrom oder schwarz anthrazit.

212





50

Proyectos en más de 50 países son la referencia de Carpyen.

HOTELS & RESTAURANTS

AC
Turino. Italy

ACCOR
- SOFITEL
Paris. France
- NOVOTEL
Leeds. UK

BARCELÓ
Almería. Spain

CATALONIA
Barcelona. Spain

HILTON
Paris. France
Dusseldorf, Munich and Nuremberg. Germany
Barcelona. Spain
Zurich. Switzerland
Brighton, Leicester and Watford. UK

HOLIDAY INN
Rugby, Portsmouth, Gloucester, Coventry,
Oxford, Birmingham City and Reading. UK

LE MÉRIDIDIEN
Minneapolis. USA

MELIÀ
Montevideo. Uruguay

NH
- Several in Barcelona, Cádiz, Madrid, etc.
Spain
- NH BARBIZON PALACE HOTEL
Amsterdam. The Netherlands

SANA
- SANA MALHOA HOTEL
Lisboa. Portugal
- SANA METROPOLITAN HOTEL
Lisboa. Portugal

Europa
HOTEL CAYRE SA
Paris. France

FRITZWILLIAM HOTEL
Dublin. Ireland

LUTECIA HOTEL
Lisboa. Portugal

INATEL HOTEL
Oeiras, Lisboa. Portugal

HOTEL CITY IBEROSTAR
Cádiz. Spain

HOTEL CONDES DE BARCELONA
Barcelona. Spain

HOTEL DERBY
Barcelona. Spain

HOTEL DIPLOMATIC
Barcelona. Spain

HOTEL FONTANALS
Barcelona. Spain

HOTEL REY JUAN CARLOS I
Barcelona. Spain

HOTEL TARO BEACH
Fuerteventura. Canary Island

HOTELS AGUAMARINA
Menorca. Spain

SOFA HOTEL
Istanbul, Turkey

ALDERMAN FENWICK HOUSE
Newcastle upon Tyne. UK

ANGEL HOUSE
Cardiff. UK

CUMBERLAND HOTEL
London. UK

HOTEL MOUNT COUNTRY HOUSE
Rugby. UK

NORTON HOUSE
Edinburg. UK

ROYAL YORK HOTEL
York. UK

America
CAPITOL HOTEL
Florida. USA

Asia
GINZA EAST RESIDENTIAL COMPLEX
Tokyo. Japan

MARINA MANDARIN HOTEL
Singapore

AIRPORTS VIP LOUNGES & TRAIN STATIONS

MADRID AND BARCELONA
Spain

MADRID-ZARAGOZA
Spain

MANCHESTER
UK

MUNICH
Germany

BANKS

BANCO BILBAO VIZCAYA BBVA
Almost all branches. Spain

BANCO SABADELL ATLÁNTICO
Spain

LA CAIXA
Spain

ENTERTAINMENT & CULTURAL PLACES

DUNKERRON WOODS HOLIDAY HOUSES
Kerry. Ireland

AUCKLAND CASINO
Auckland. New Zealand

ESTORIL CASINO
Estoril. Portugal

CLUB DE GOLF FONTANALS
Girona. Spain

CLUB DE GOLF SANT CUGAT
Barcelona. Spain

DAVID LLOYD TENNIS CLUB
Woking, Epsom, Oxford, Kingston, Finchley,
Bromsgrove, Fulham. UK

BIBLIOTECA UNIVERSIDAD REY JUAN
CARLOS I
Fuenlabrada, Madrid. Spain

LONDON BUSINESS SCHOOL
London. UK

SPA HILTON ROYAL PALACE
Jeddah. Saudi Arabia

82

nirvana city naomi tria gala
aura aurita galilea gilda scott
harry viper phyton square
basic rita jacky kiwi waki
mini odyssey boxster top clara
sunset orly hotel zénit área
valentina alfa gamma mercury
infiniti fritz hans suite berta
marta erik sun kao ris
hamilton betty rondo oval
gallery mondrian dial flash
focus focus mini irma funi
max nick frida petra tommy
finger metropol tema douglas
aladina master japan nairobi
pocket pascualina willy hi-fi
carla augusta cónica barcino
atenea omara poppy candel

PLAFONES
CEILING LAMPS
DECKENLEUCHTEN



basic
80



boxster
94



clara
98



dial
146



flash
148



focus
152



focus mini
153



fritz
118

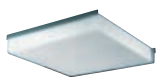

hamilton
134



harry
64



jacky
84



kiwi
86



mini
90



odyssey
92



orly
103



oval
140



python
74



rita
82



rondo
138



scott
56



square
78



sunset
100



top
96



viper
70



waki
88

218

APLIQUES
WALL LAMPS
WANDLEUCHTEN



alfa
113



area
108



aura
37



barcino
202



basic
80

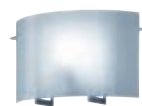

berta
122



betty
136



boxster
94



city
20



dial
146

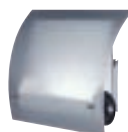

erik
126



flash
148



focus
152

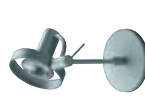

focus mini
153



fritz
118

Medidas en cm.
All measures in cm.
Maße in cm.

APLIQUES
WALL LAMPS
WANDLEUCHTEN



gala
32



gala mini
33



gamma
112



gilda
52

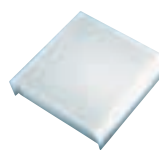

hamilton
134



hans
120



hotel
104

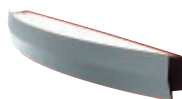

infiniti
116



jacky
84



kao
130



kiwi
86



marta
124



mercury
114



mercury
114



mini
90



mondrian
144



orly
102



oval
140



pascualina
190



python
75



ris
132



ris
132



rita
82



rondo
138

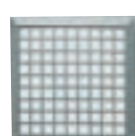

square
78



suite
122

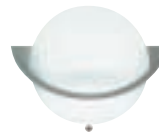

sun
128



sunset
100

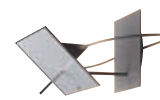

valentina
110



viper
70



waki
88



zénit
106



APLIQUES CUADROS
PICTURE LAMPS
BILDERLEUCHTEN



gallery
142



mondrian
144



dial
146



flash
148



focus
152



focus mini
153

FOCOS
SPOTLIGHTS
STRAHLER

COLGANTES
SUSPENSION LAMPS
PENDELLEUCHTEN



220 SOBREMESAS
TABLE LAMPS
TISCHLEUCHTEN



Medidas en cm.
All measures in cm.
Maße in cm.

PINZAS
CLIP-ON LAMP
KLEMMLEUCHTEN



city
18

hi-fi
194

pascualina
190

python
76

viper
72

willy
192

PIE SUELO
FLOOR LAMPS
STEHLEUCHTEN



aladina
180

atenea
204

augusta
198

aura
38

barcino
203

carla
196

city
14

cónica
200



douglas
178

gala
30

galilea pie / floor
42

galilea maxi
48

harry
58

harry jardín
62

nirvana
8



naomi
22

omara
206

tema
177

tria
26

tria halógena
28

LUCES DE ACEITE
OIL LAMPS
MINERALÖL-LEUCHTER



candel
210

poppy
212

aladina	180, 181	japan	184, 185
alfa	112, 113	kao	130, 131
área	108, 109	kiwi	86, 87
atenea	204, 205	marta	124, 125
augusta	198, 199	master	182, 183
aura	34, 35, 36, 37, 38, 39	max	160, 161, 162, 163
aurita	40, 41	mercury	114, 115
barcino	202, 203	metropol	174, 175
basic	80, 81	mini	90, 91
berta	122	mondrian	144, 145
betty	136, 137	nairobi	186, 187
boxster	94, 95	naomi	22, 23, 24, 25
candel	210, 211	nick	164, 165
carla	196, 197	nirvana	8, 9, 10, 11, 12, 13
city	14, 15, 16, 17, 18, 19, 20, 21	odyssey	92, 93
clara	98, 99	omara	206, 207
cónica	200, 201	orly	102, 103
dial	146, 147	oval	140, 141
douglas	178, 179	pascualina	190, 191
erik	126, 127	petra	168, 169
flash	148, 149, 150, 151	pocket	188, 189
finger	172, 173	poppy	212, 213
focus	152	python	74, 75, 76, 77
focus mini	153	ris	132, 133
frida	166, 167	rita	82, 83
fritz	118, 119	rondo	138, 139
funi	158, 159	scott	54, 55, 56, 57
gala	30, 31, 32, 33	square	78, 79
galilea	42, 43, 44, 45, 46, 47, 48, 49	suite	122, 123
gallery	142, 143	sun	128, 129
gamma	112	sunset	100, 101
gilda	50, 51, 52, 53	tema	176, 177
hamilton	134, 135	tommy	170, 171
hans	120, 121	top	96, 97
harry	58, 59, 60, 61, 62, 63, 64, 65, 66, 67	tria	26, 27, 28, 29
hi-fi	194, 195	valentina	110, 111
hotel	104, 105	viper	70, 71, 72, 73
infiniti	116, 117	waki	88, 89
irma	156, 157	willy	192, 193
jacky	84, 85	zénit	106, 107

	BOMBILLAS BULBS LAMPEN	TRANSFORMADOR TRANSFORMERS TRANSFORMATOREN	EXTERIOR OUTDOOR AUSSEN	PLAFONES CEILING LAMPS DECKENLEUCHTEN	FOCOS SPOTLIGHTS STRAHLER	APLIQUES WALL LAMPS WANDENLEUCHTEN	APLIQUES CUADROS PICTURE LAMPS BILDERLEUCHTEN	COLGANTES SUSPENSION LAMPS PENDELLEUCHTEN	SOBREMESAS TABLE LAMPS TISCHLEUCHTEN	PINZAS CLIP-ON LAMPS KLEMMLEUCHTEN	PIE SUELO FLOOR LAMPS STEHLEUCHTEN
aladina	●					●			●	●	●
alfa	●					●					
área	●●					●●					
atenea	●										●
augusta	●										●
aura	●					●		●			●
aurita	●							●			
barcino	●					●					●
basic	●●			●●		●●					
berta	●●					●●					
betty	●					●					
boxster	●●			●●		●●					
candel	●								●		
carla	●										●
city	●					●			●	●	●
clara	●			●							
cónica	●										●
dial	●	●		●	●	●					
douglas	●					●			●	●	●
erik	●					●					
flash	●			●	●	●		●			
finger	●							●			
focus	●			●	●	●					
focus mini	●			●	●	●					
frida	●							●			
fritz	●			●		●					
funi	●							●			
gala	●					●					●
gala mini	●					●			●		
galilea	●							●			●
gallery	●	●					●				
gamma	●					●					
gilda	●					●		●			
hamilton	●●			●●		●●					
hans	●					●					
harry	●		●	●				●			●
hi-fi	●	●							●		
hotel	●					●					
infiniti	●					●					
irma	●							●			
jacky	●●			●●		●●					
japan	●							●			
kao	●					●					
kiwi	●			●		●					
marta	●●					●●					
master	●	●						●			
max	●							●			
mercury	●●					●●					
metropol	●							●			
mini	●			●		●					
mondrian	●	●				●	●				
nairobi	●							●			
naomi	●							●			●
nick	●							●			
nirvana	●							●			●
odyssey	●			●							
omara	●										●
orly	●			●		●					
oval	●●		●●	●●		●●					
pascualina	●					●			●		
petra	●							●			
pocket	●							●			
poppy	●								●		
python	●	●		●		●		●	●		
ris	●●					●●					
rita	●			●		●					
rondo	●●		●●	●●		●●					
scott	●			●				●			
square	●			●		●					
suite	●					●					
sun	●					●					
sunset	●			●		●					
tema	●	●						●			●
tommy	●							●			
top	●			●							
tria	●●										●●
valentina	●					●					
viper	●			●		●			●		
waki	●●			●●		●●					
willy	●	●							●		
zénit	●●					●●					



Carpyen S.L. se reserva el derecho a efectuar modificaciones en las características técnicas y acabados de los productos que se muestran en éste catálogo.
Carpyen S.L. reserve the right to carry out any modification to the technical features and finish of the products displayed in the catalogue without prior notice.
Carpyen S.L. behält sich das Recht vor, Änderungen an Design und Technik der im Katalog abgebildeten Leuchten ohne vorherige Ankündigung durchzuführen.

