



VENICE ITSELF

“façon de venise®”

“façon de venise[®]”



CREATING LIGHT, DISCOVERING THE WORLD

Describing and discovering new places and fantasies, light effects, colours and refractions: new Façon de Venise creations are from the very heart of Venice and its traditions, offering attractive contemporary style.

SCOPRIRE IL MONDO,
DISEGNARE LA LUCE

DISEGNARE LA LUCE,
SCOPRIRE IL MONDO

Raccontare e scoprire nuovi luoghi e fantasie,
giochi di luce, colori e rifrazioni:

dal respiro profondo di Venezia, delle sue storie,
ecco le nuove creazioni Façon de Venise,
per uno stile contemporaneo e coinvolgente.



INDEX

- 2_ 24 CHANDELIER
- 26_ 52 MISSTRASS
- 56_ 74 LIMELIGHT
- 76_ 96 AQUA
- 100_ 114 BLOOM
- 116_ 130 MALMZI
- 132_ 146 MR. E
- 148_ 164 FV
- 168_ 182 CLAUDE
- 184_ 200 DISH



CHANDELIER

design peter lunetta

MERIPRS
SUZANNE
EMY
REBECCA
MAMO
BARBARA
NICOLE
MARIANGE
VANESSA
CHRISTINE



**MERIPIRS,
LAMPADARIO IN GOMMA SPECIALE COLORATA/
LAMP IN SPECIAL COLOURED RUBBER**

DESIGN PETER LUNETTA, 2005

**MERIPRS,
LAMPADARIO IN GOMMA SPECIALE COLORATA/
LAMP IN SPECIAL COLOURED RUBBER**

DESIGN PETER LUNETTA, 2005

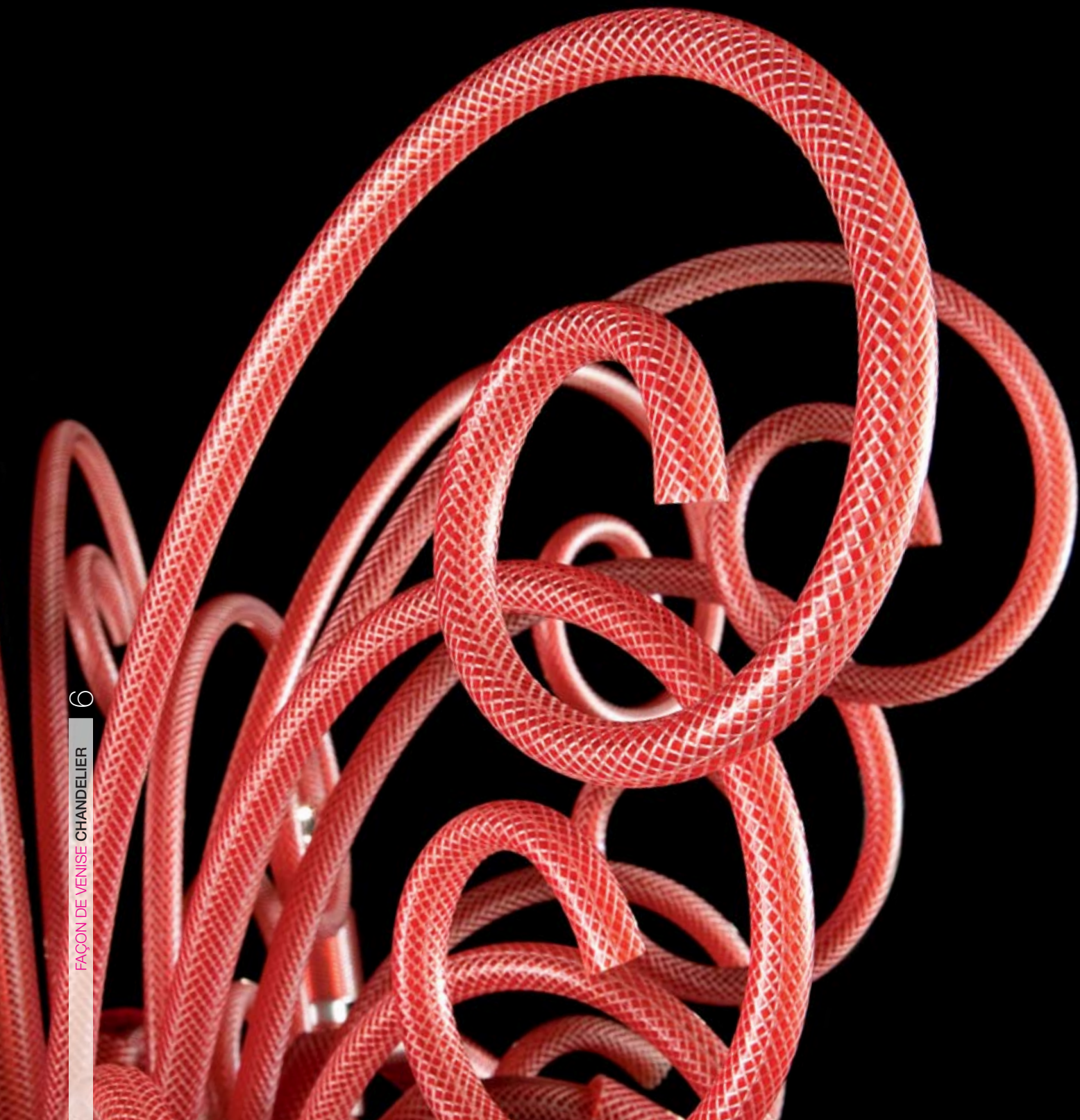



INTO THE LIGHT

SUZANNE,
LAMPADARIO IN GOMMA SPECIALE COLORATA/
LAMP IN SPECIAL COLOURED RUBBER

DESIGN PETER LUNETTA, 2005



12

FAÇON DE VENISE CHANDELIER

**SUZANNE,
LAMPADARIO IN GOMMA SPECIALE COLORATA/
LAMP IN SPECIAL COLOURED RUBBER**

DESIGN PETER LUNETTA, 2005



13

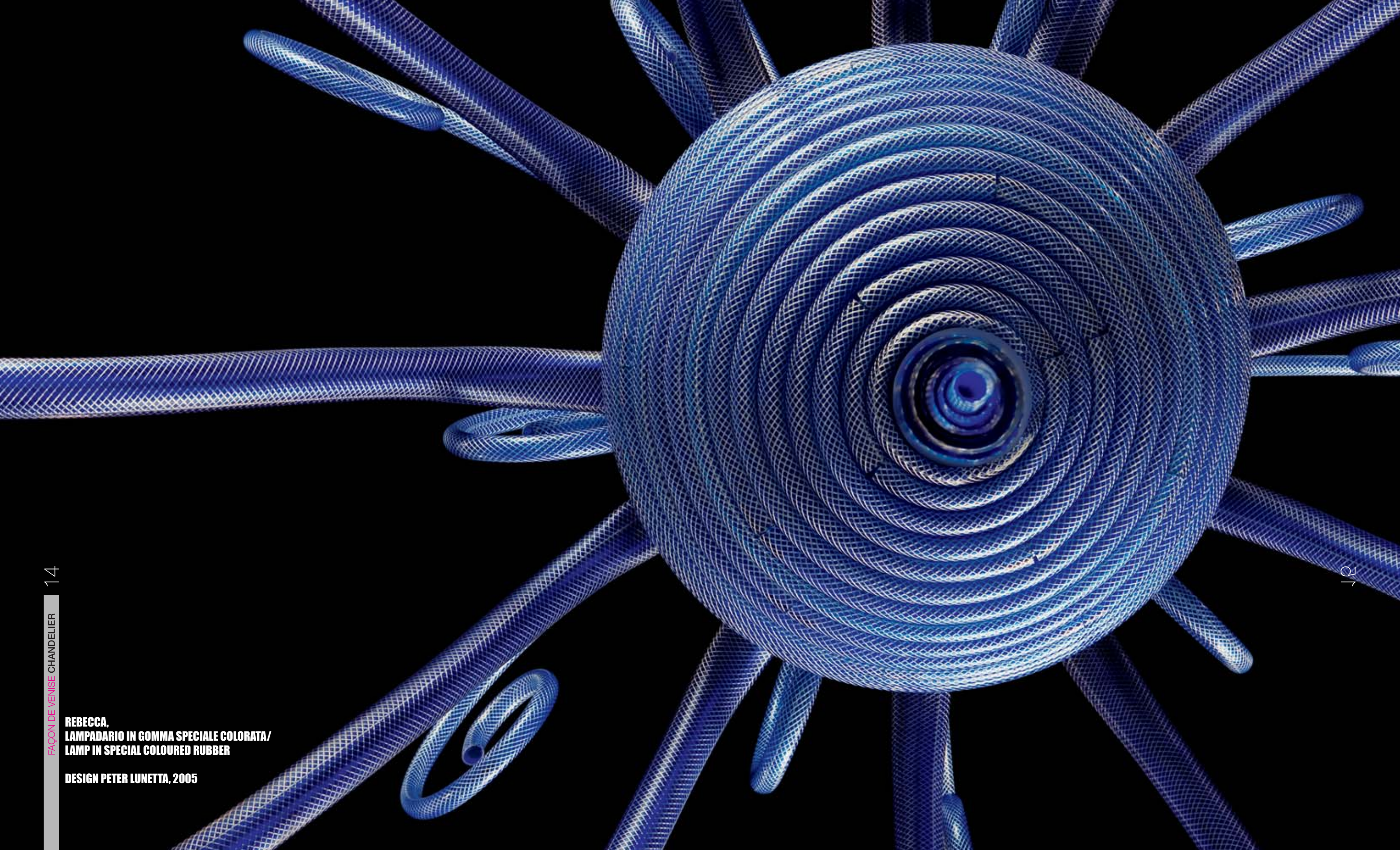

**REBECCA,
LAMPADARIO IN GOMMA SPECIALE COLORATA/
LAMP IN SPECIAL COLOURED RUBBER**

DESIGN PETER LUNETTA, 2005



BARBARA,
LAMPADARIO IN GOMMA SPECIALE COLORATA/
LAMP IN SPECIAL COLOURED RUBBER

DESIGN PETER LUNETTA, 2005

PRIVATE PIER _ SESTIERE CANNAREGIO / VENICE _ 9.25 AM



**BARBARA,
LAMPADARIO IN GOMMA SPECIALE COLORATA/
LAMP IN SPECIAL COLOURED RUBBER**

DESIGN PETER LUNETTA, 2005



20

FAÇON DE VENISE CHANDELIER

"CAFFÈ FLORIAN" _ S. MARCO SQUARE / VENICE _ 11.00 AM



15

**CHRISTINE,
APPLIQUE IN GOMMA SPECIALE COLORATA/
WALL LAMP IN SPECIAL COLOURED RUBBER**

DESIGN PETER LUNETTA, 2005





CHANDELIER

design peter lunetta

Lampadario in gomma nei colori:
bianco, ambra, nero, rosso fuoco, fuxia,
blu, verde acido.
Montatura in metallo bianco.

Rubber lamp in the following colours:
white, amber, black, flame red, fuchsia,
blue and acid green.
Fixture in white metal.

60W E14  ●
11W E14  ●



IP

IP 44

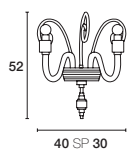

CHRISTINE 2P



2 x  ● or 2 x  ●

REBECCA 12L

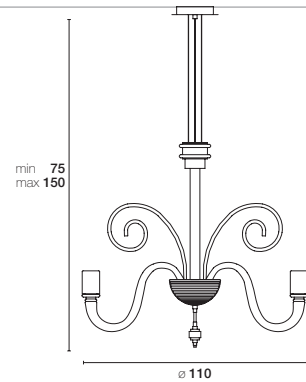

12 x  ● or 12 x  ●

MERIPIRS 8L

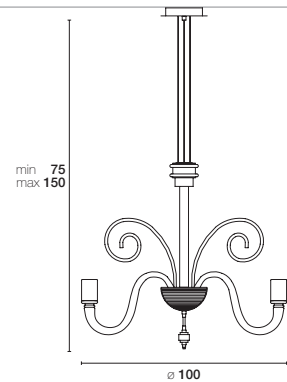

8 x  ● or 8 x  ●

EMY 8L

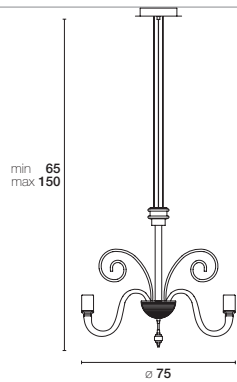

8 x  ● or 8 x  ●

SUZANNE 8L

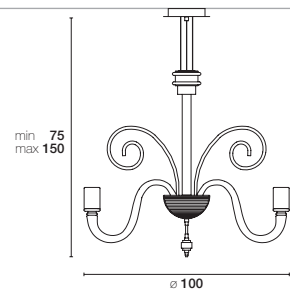

8 x  ● or 8 x  ●

BARBARA 6L

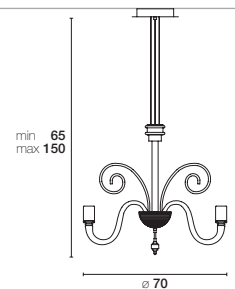

6 x  ● or 6 x  ●

NICOLE 3L

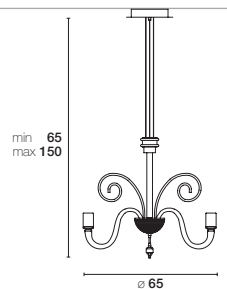

3 x  ● or 3 x  ●

MARIANGE 8L

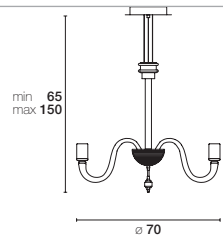

8 x  ● or 8 x  ●

VANESSA 6L

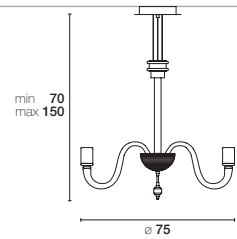

6 x  ● or 6 x  ●

MAMO 6L

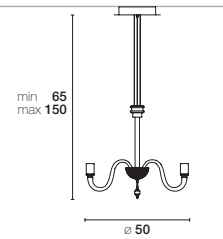

3 x  ● or 3 x  ●

MAMO 3L

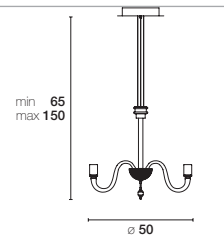

3 x  ● or 3 x  ●

CHANDELIER

table of contents



MISSTRASS

design mauro marzollo



**MISSTRASS_PL100,
PLAFONIERA MODULARE IN PMMA/
MODULAR CEILING LAMP IN PMMA**

DESIGN MAURO MARZOLLO, 2008

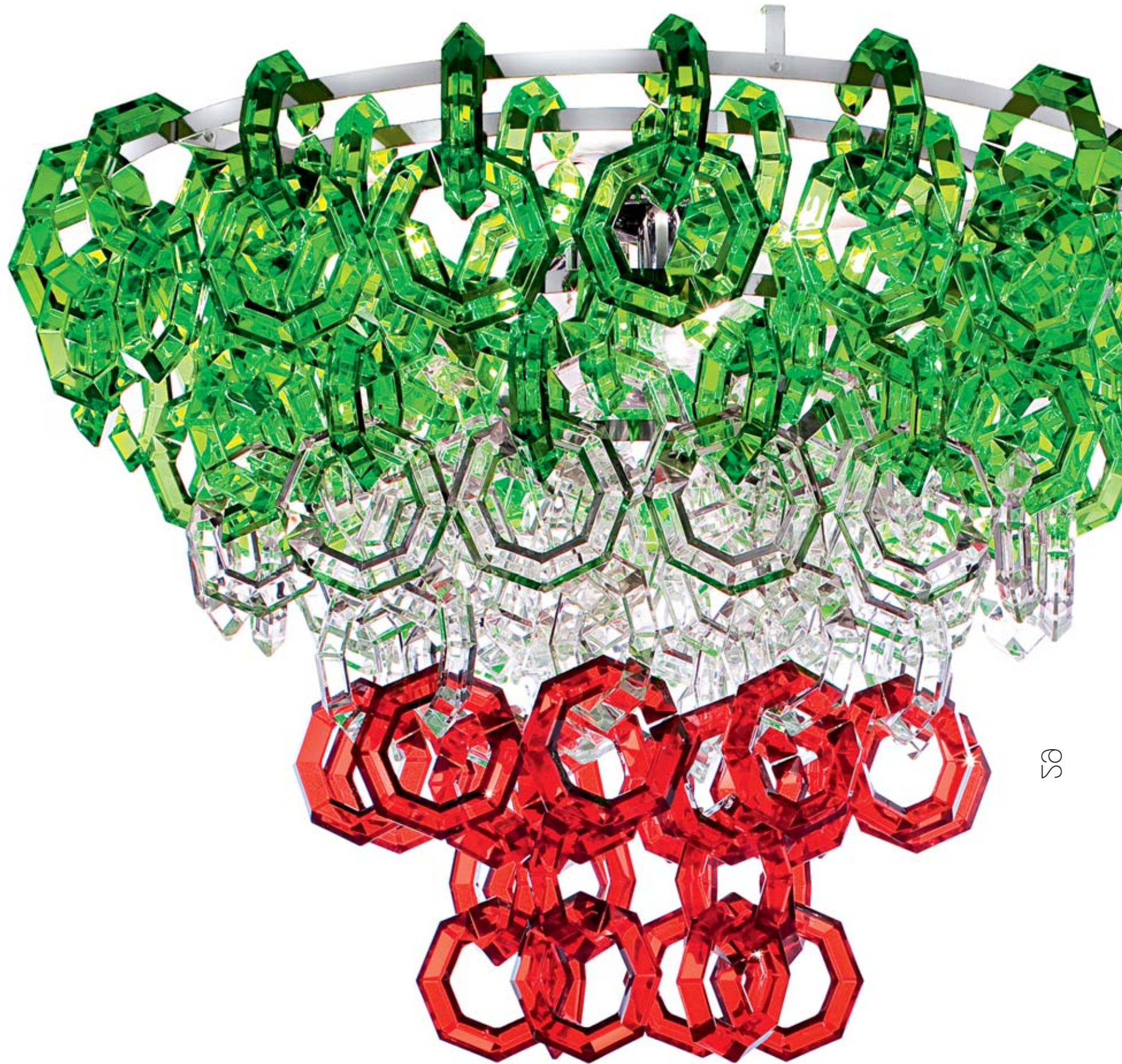

MISSTRASS_PL70 L
PLAFONIERA MODULARE IN PMMA/
MODULAR CEILING LAMP IN PMMA

DESIGN MAURO MARZOLLO, 2008



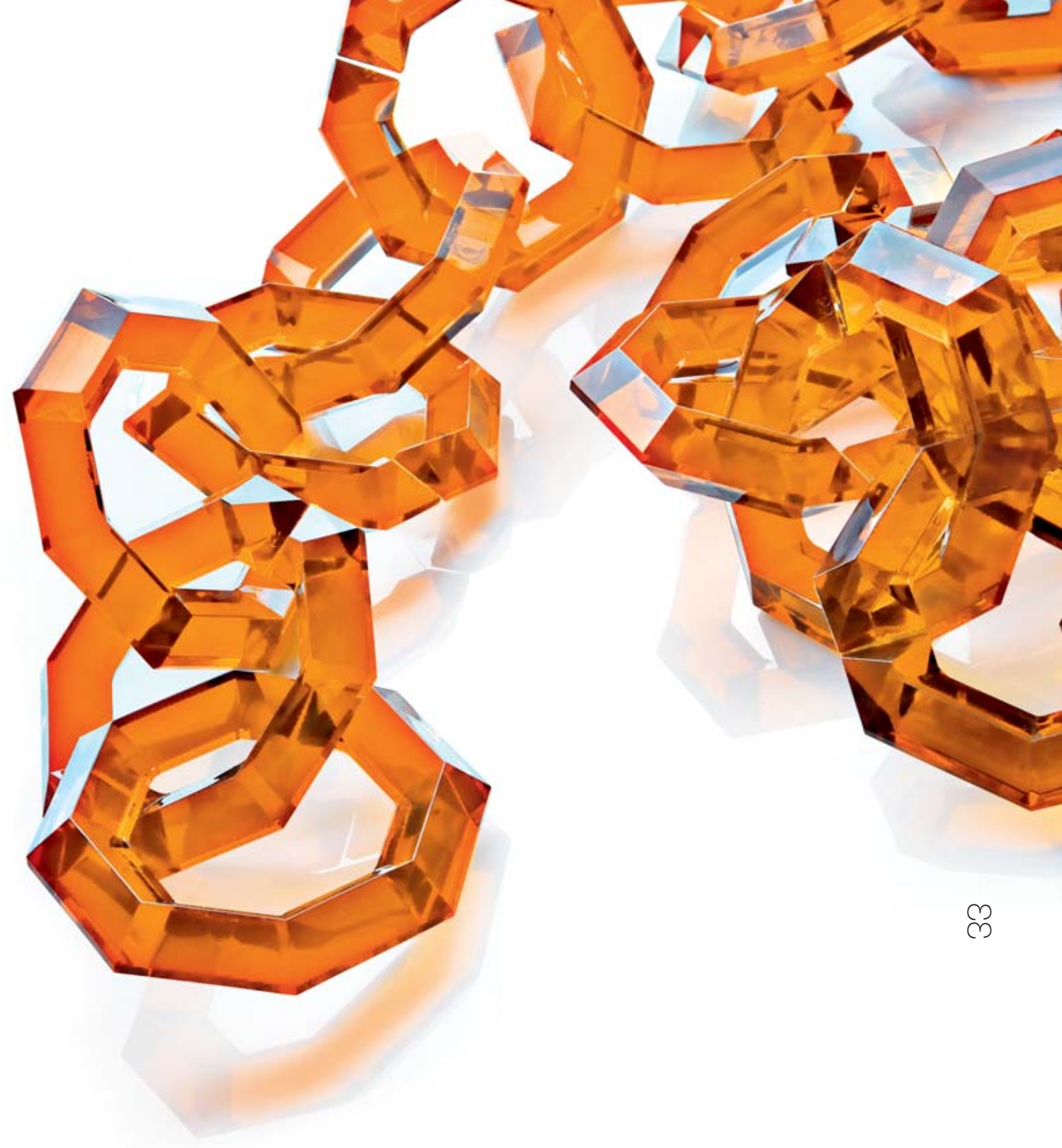



MISSTRASS_PL70
PLAFONIERA MODULARE IN PMMA /
MODULAR CEILING LAMP IN PMMA

DESIGN MAURO MARZOLLO, 2008

"CENTRALE" LOUNGE BAR _ S. MARCO / VENICE _ 12.55 AM



MISSTRASS _ SO 50
SOSPENSIONE MODULARE IN PMMA/
MODULAR SUSPENDED LAMP IN PMMA

MISSTRASS _ AP
APPLIQUE MODULARE IN PMMA/
MODULAR WALL LAMP IN PMMA

DESIGN MAURO MARZOLLO, 2008



38
FAÇON DE VENISE MISSTRASS

MISSTRASS PL35
PLAFONIERA MODULARE IN PMMA/
MODULAR CEILING LAMP IN PMMA

DESIGN MAURO MARZOLLO, 2008



39

MISSTRASS _ PL50 C
PLAFONIERA MODULARE IN PMMA/
MODULAR CEILING LAMP IN PMMA

DESIGN MAURO MARZOLLO, 2008

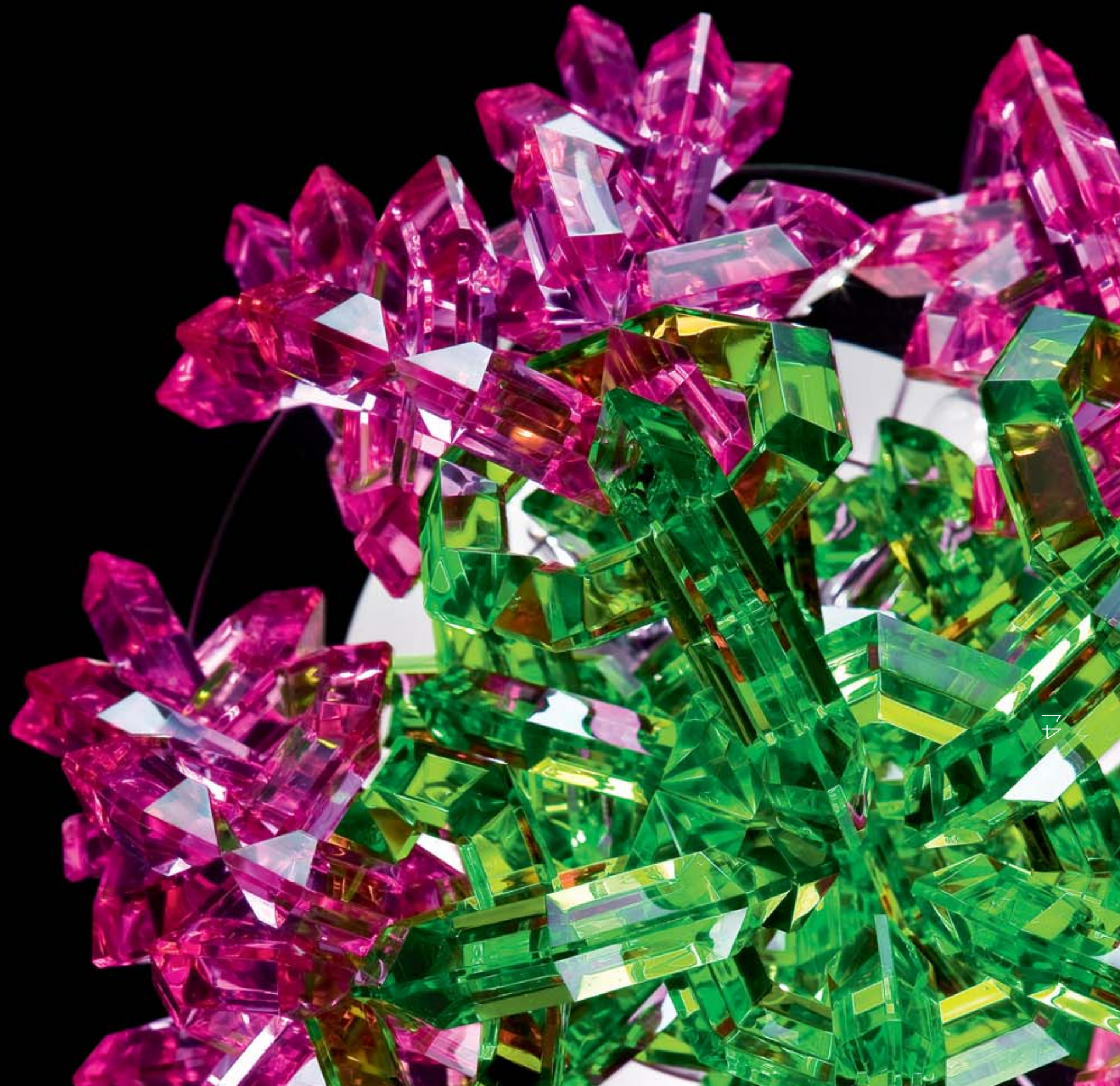





MISSTRASS_PL100
PLAFONIERA MODULARE IN PMMA/
MODULAR CEILING LAMP IN PMMA

DESIGN MAURO MARZOLLO, 2008



MISSTRASS_S0
SOSPENSIONE MODULARE IN PMMA/
MODULAR SUSPENDED LAMP IN PMMA

DESIGN MAURO MARZOLLO, 2008







50

FAÇON DE VENISE MISSTRASS

MISSTRASS AP
APPLIQUE MODULARE IN PMMA/
MODULAR WALL LAMP IN PMMA

DESIGN MAURO MARZOLLO, 2008



12

Diffusore realizzato con elementi componibili in pmma nei colori: cristallo, lampone, lime, carbone, miele, ciliegia.
Montatura inox lucido.

Diffuser comprising modular elements in PMMA in the following colours: crystal, raspberry, lime, coal black, honey and cherry.
Fixture in polished stainless steel.

- 40W E14
- 7W E14
- 100W E27
- 100W E27 HALOPAR 30
- 23W E27
- 20W E27
- 60W E14
- 60W E27
- 15W E27

AP

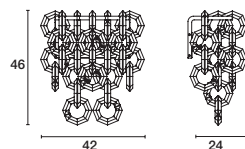

2 x or 2 x

PL 35

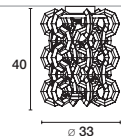

1 x or 1 x or 1 x

PL 35 L

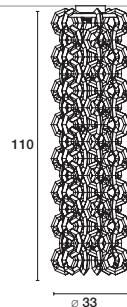

1 x or 1 x or 1 x

PL 50

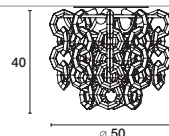

5 x or 5 x

PL 50 L

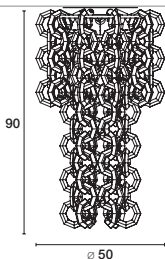

5 x or 5 x

PL 70

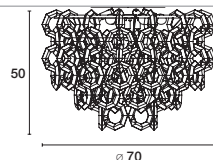

9 x or 9 x

PL 100

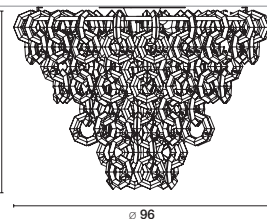

6 x + 3 x or 6 x + 3 x

SO 50

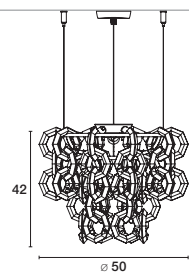

5 x or 5 x

SO 70

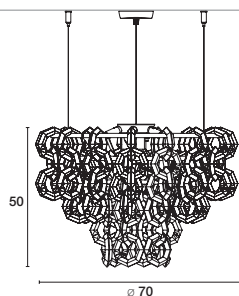

9 x or 9 x

SO 100

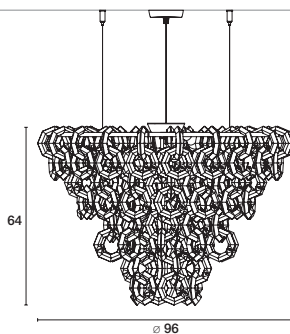

6 x + 3 x or 6 x + 3 x

SO

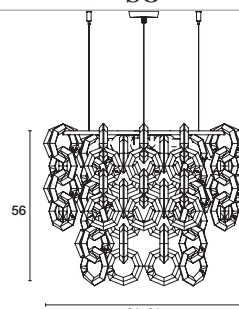

2 x or 2 x

BINARIO 1

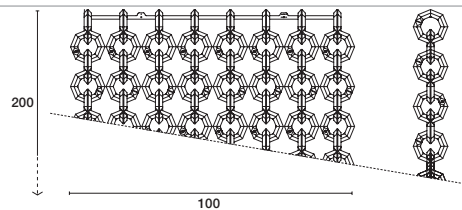

BINARIO 2

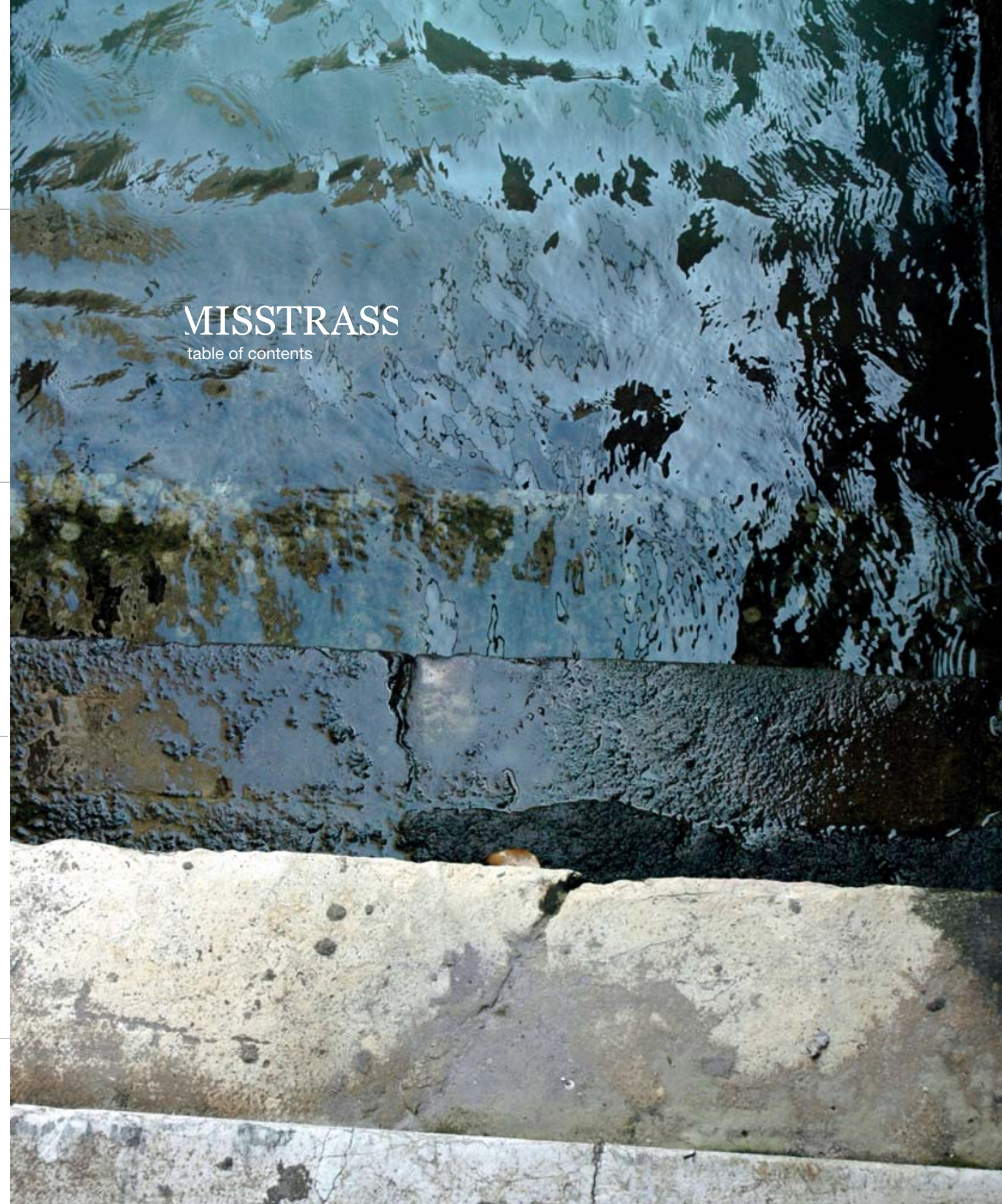
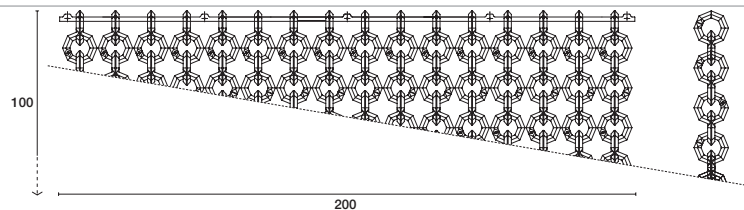

MISSTRASS
table of contents



ARCHITETTURE DI LUCE

ARCHITECTURAL LIGHTING ELEMENTS

Contrasting light and shade, reflected landscapes, colours and global voices and silence in the fog: the most genuine atmospheres of the lagoon city inspire the contemporary path taken by Façon de Venise.

ARCHITETTURE DI LUCE

Contrasti di luci ed ombre, paesaggi di riflessi e mosaici dai mille colori, voci dal mondo e silenzi nella nebbia: dalle atmosfere più autentiche della città lagunare traggono ispirazione forme e colori che animano il percorso contemporaneo di Façon de Venise.



LIMELIGHT

design lorenzo bertocco

LIMELIGHT _ 28.6
LAMPADARIO DESTRUTTURATO IN CRISTALLO /
LIGHT WITH SEPARATE ELEMENTS IN CRYSTAL GLASS

DESIGN LORENZO BERTOCCO, 1999

LIMELIGHT _ 28.6
**LAMPADARIO DESTRUTTURATO IN CRISTALLO/
LIGHT WITH SEPARATE ELEMENTS IN CRYSTAL GLASS**

DESIGN LORENZO BERTOCCO, 1999





LIMELIGHT_12.4
**LAMPADARIO DESTRUTTURATO IN CRISTALLO/
LIGHT WITH SEPARATE ELEMENTS IN CRYSTAL GLASS**

DESIGN LORENZO BERTOCCO, 1999





LIMELIGHT _ 1.1
**FARETTO DESTRUTTURATO IN CRISTALLO/
SPOTLIGHT WITH SEPARATE ELEMENTS IN CRYSTAL GLASS**

DESIGN LORENZO BERTOCCO, 1999









LIMELIGHT
design lorenzo bertocco

Diffusore in vetro cristallo
trasparente o nero e trasparente.
Montatura in inox lucido.

Diffuser in transparent or black/transparent
crystal glass.
Fixture in polished stainless steel.

50 W GU10  ●
50 W GU53 QR111  ●

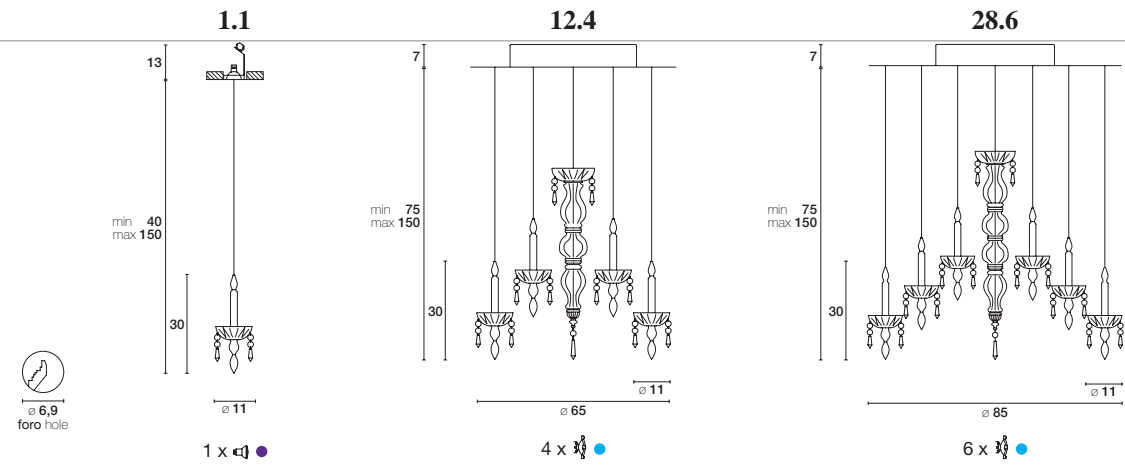

LIMELIGHT
table of contents



AQUA design brian rasmussen

AQUA _ SO I
COMPOSIZIONE MODULARE DI PARALUMI IN TESSUTO /
MODULAR ARRANGEMENT OF LAMPSHADES IN FABRIC

DESIGN BRIAN RASMUSSEN, 2010







AQUA _ SO 150
COMPOSIZIONE MODULARE DI PARALUMI IN TESSUTO /
MODULAR ARRANGEMENT OF LAMPSHADES IN FABRIC

DESIGN BRIAN RASMUSSEN, 2010



AQUA _ SO 90
COMPOSIZIONE MODULARE DI PARALUMI IN TESSUTO/
MODULAR ARRANGEMENT OF LAMPSHADES IN FABRIC

DESIGN BRIAN RASMUSSEN, 2010

PRIVATE HOUSE _ S. ELENA GARDENS / VENICE _ 10.25 AM



AQUA _ SO 21 CUSTOM
COMPOSIZIONE MODULARE DI PARALUMI IN TESSUTO/
MODULAR ARRANGEMENT OF LAMPSHADES IN FABRIC

DESIGN BRIAN RASMUSSEN, 2010







AQUA _ SO 90
COMPOSIZIONE MODULARE DI PARALUMI IN TESSUTO /
MODULAR ARRANGEMENT OF LAMPSHADES IN FABRIC

DESIGN BRIAN RASMUSSEN, 2010

Sistema modulare composto da paralumi diffusori nei colori: verde erba, bianco crema, blu mare, azzurro cielo, marrone terra, biancolatte, grigio alluminio, nero petrolio. Montatura in metallo bianco.

Modular system comprising diffuser lampshades in the following colours: grass green, cream white, ocean blue, sky blue, earth brown, milk white, aluminium grey and petrol black. Fixture in white metal.

60W E27  ●
20W E27  ●

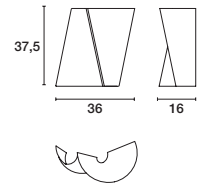

AP

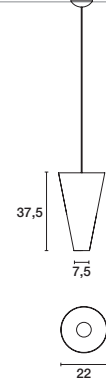

2 x  ● or 2 x  ●

SO 1L DOWN



1 x  ● or 1 x  ●

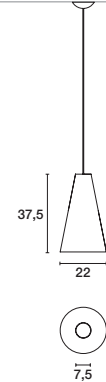

SO 1L UP

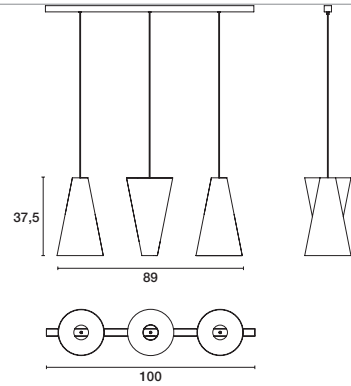

1 x  ● or 1 x  ●

SO 3L



3 x  ● or 3 x  ●

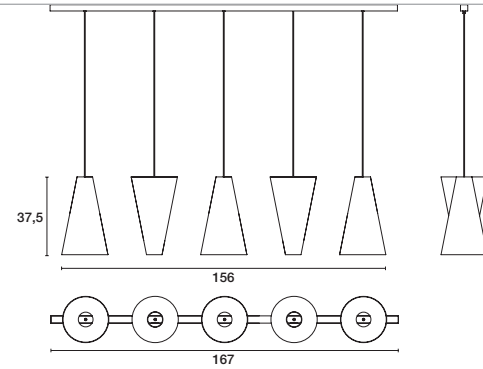

SO 5L

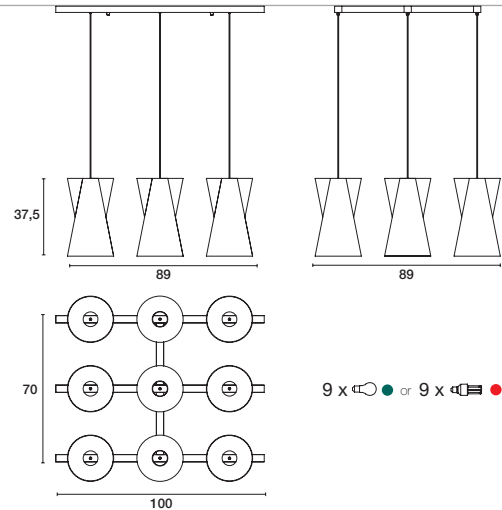

5 x  ● or 5 x  ●

SO 9Q



9 x  ● or 9 x  ●

SO 15Q

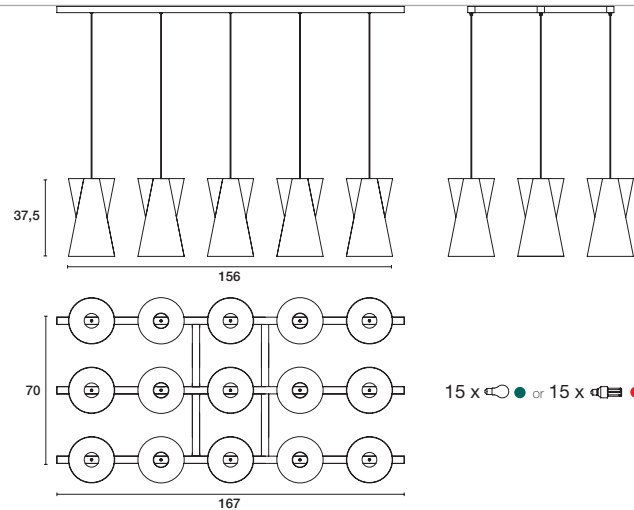

15 x  ● or 15 x  ●



STORIE E
CONTEMPORANEO

TRADITIONS AND CONTEMPORARY STYLE

Natural elements and man's creations have always existed in Venice:
an ideal place for designing and making original lighting elements.
But everyday reality requires research.
Façon de Venise contaminates Venetian traditions, discovers new paths and looks beyond the horizon,
with a desire to excite and seize the style of our times.

STORIE E CONTEMPORANEO

A Venezia da sempre si incontrano elementi della natura e idee dell'uomo:
un luogo ideale per disegnare e costruire forme di luce originali.
Ma la realtà odierna ci impone la ricerca.
Façon de Venise contamina memorie veneziane, scopre nuove vie
e volge lo sguardo oltre l'orizzonte,
con il desiderio di emozionare e catturare il gusto del nostro tempo.



BLOOM

design brian rasmussen



**BLOOM _ SO 120,
SOSPENSIONE IN METALLO TORNITO E CURVATO/
SUSPENDED LAMP IN CURVED LATHE-TURNED METAL**

DESIGN BRIAN RASMUSSEN, 2009



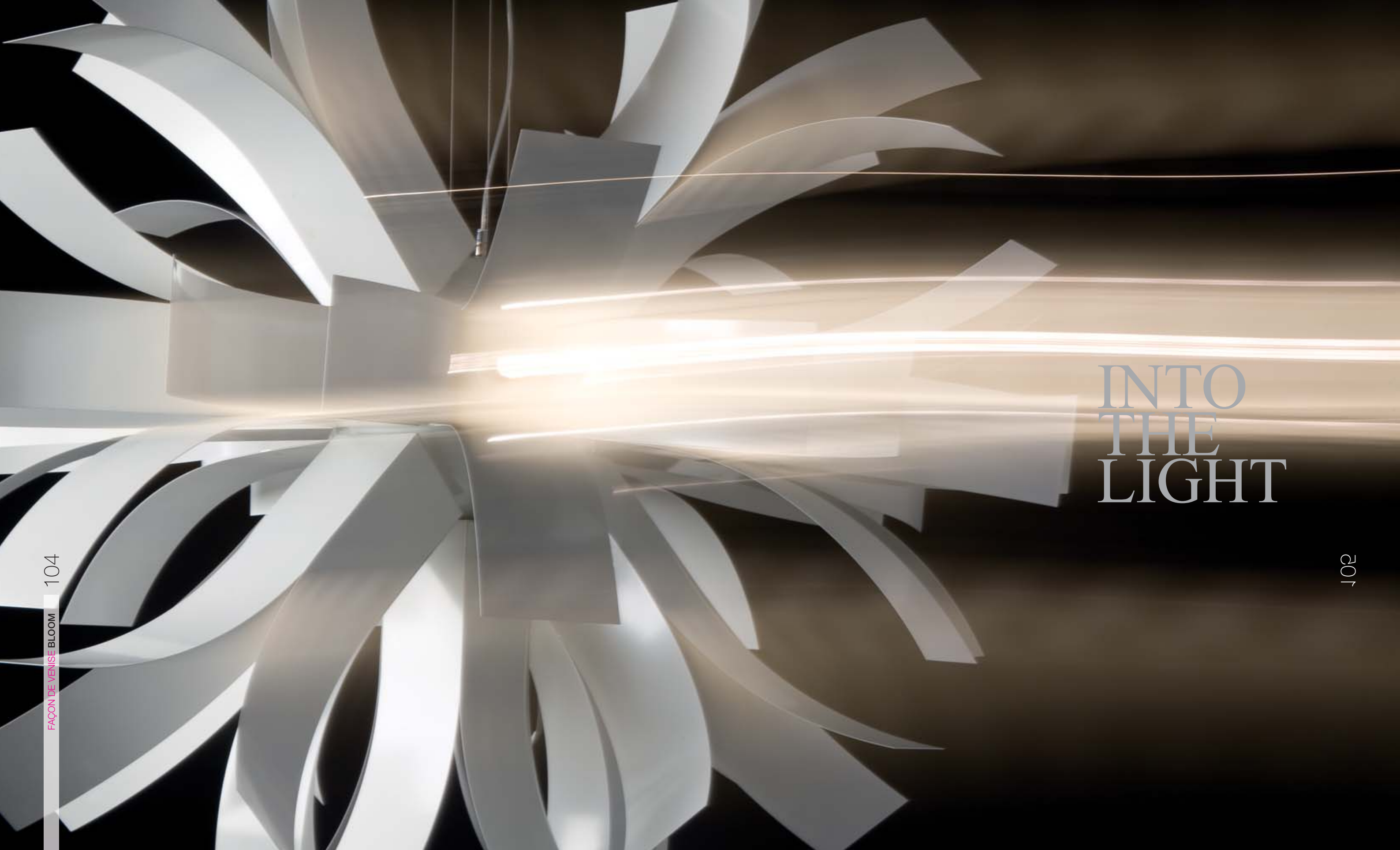

INTO THE LIGHT

**BLOOM SO 120,
SOSPENSIONE IN METALLO TORNITO E CURVATO/
SUSPENDED LAMP IN CURVED LATHE-TURNED METAL**

DESIGN BRIAN RASMUSSEN, 2009

**BLOOM _ PL 120,
PLAFONIERA IN METALLO TORNITO E CURVATO/
CEILING LAMP IN CURVED LATHE-TURNED METAL**

DESIGN BRIAN RASMUSSEN, 2009













**BLOOM _ SO 80,
SOSPENSIONE IN METALLO TORNITO E CURVATO/
SUSPENDED LAMP IN CURVED LATHE-TURNED METAL**

DESIGN BRIAN RASMUSSEN, 2009

Diffusore in metallo bianco o bianco / foglia oro.
Montatura in metallo bianco o foglia oro.

Diffuser in white metal or white / gold leaf.
Fixture in white metal or gold leaf.

100W E27  
20W E27  
60W E27  



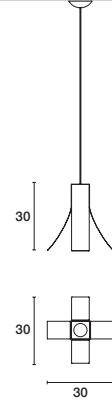

1.30

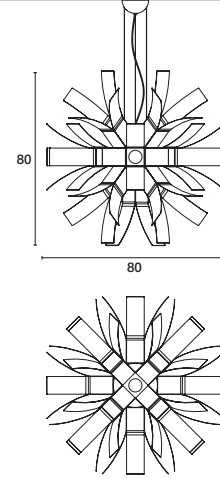

1 x   or 1 x  





SO 80

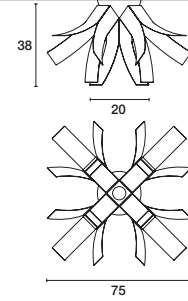

17 x   or 17 x  

PL 80



5 x   or 5 x  

1.45

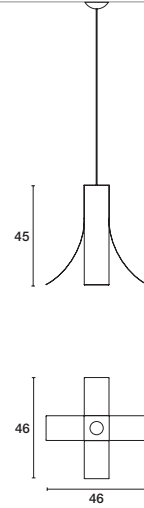

1 x   or 1 x  



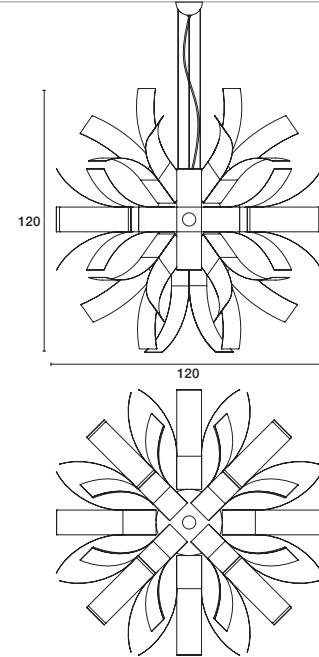

SO 120

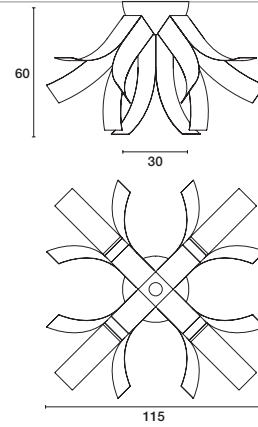

17 x   or 17 x  

PL 120



5 x   or 5 x  

BLOOM
table of contents

design lorenzo bertocco
MALIVIZI

116

117

MALIVIZI _SO 50
**SOSPENSIONE IN LEGNO CURVATO/
SUSPENDED LAMP IN CURVED WOOD**

DESIGN LORENZO BERTOCCO, 2007



MALIVIZI_SO 60
**SOSPENSIONE IN LEGNO CURVATO/
SUSPENDED LAMP IN CURVED WOOD**

DESIGN LORENZO BERTOCCO, 2007



MALIVIZI_TR
**PIANTANA CON PARALUME IN LEGNO CURVATO/
FLOOR LAMP WITH LAMPSHADE IN CURVED WOOD**

DESIGN LORENZO BERTOCCO, 2007





MALIVIZI_TA
**LAMPADA DA TAVOLO CON PARALUME IN LEGNO CURVATO/
TABLE LAMP WITH LAMPSHADE IN CURVED WOOD**

DESIGN LORENZO BERTOCCO, 2007





Diffusore in legno con fasce alternate di faggio, pero e bolivar.
Montatura in metallo nero lucido per la lampada da terra e quella da tavolo.
Metallo bianco per la sospensione.

Diffuser in wood with alternating strips in beech, pear wood and bolivar wood.
Fixture in gloss black metal for the floor lamp and table lamp.
Fixture in white metal for the suspended lamp.

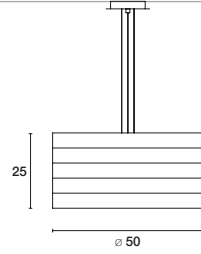

SO50

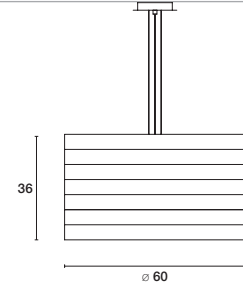

1 x  or 1 x  or 1 x 

SO60



1 x  or 1 x  or 1 x 

TA

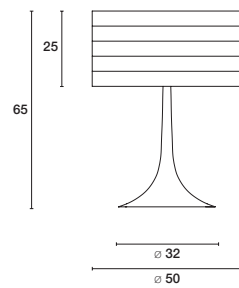

1 x  with dimmer

TR

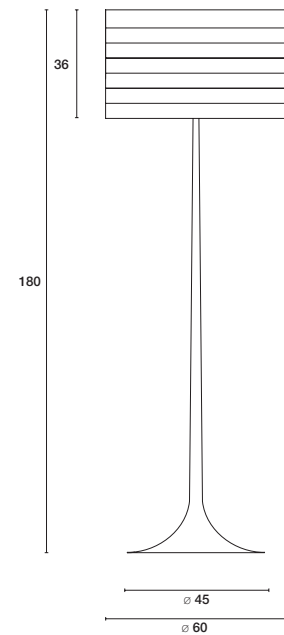

1 x  with dimmer



MR. E
design studio lunica

MR. E _ SO 80
SOSPENSIONE MODULARE IN PMMA /
MODULAR SUSPENDED LAMP IN PMMA

DESIGN STUDIO LUNICA, 2010







MR. E _ PL 40
PLAFONIERA MODULARE IN PMMA /
MODULAR CEILING LAMP IN PMMA

DESIGN STUDIO LUNICA, 2010

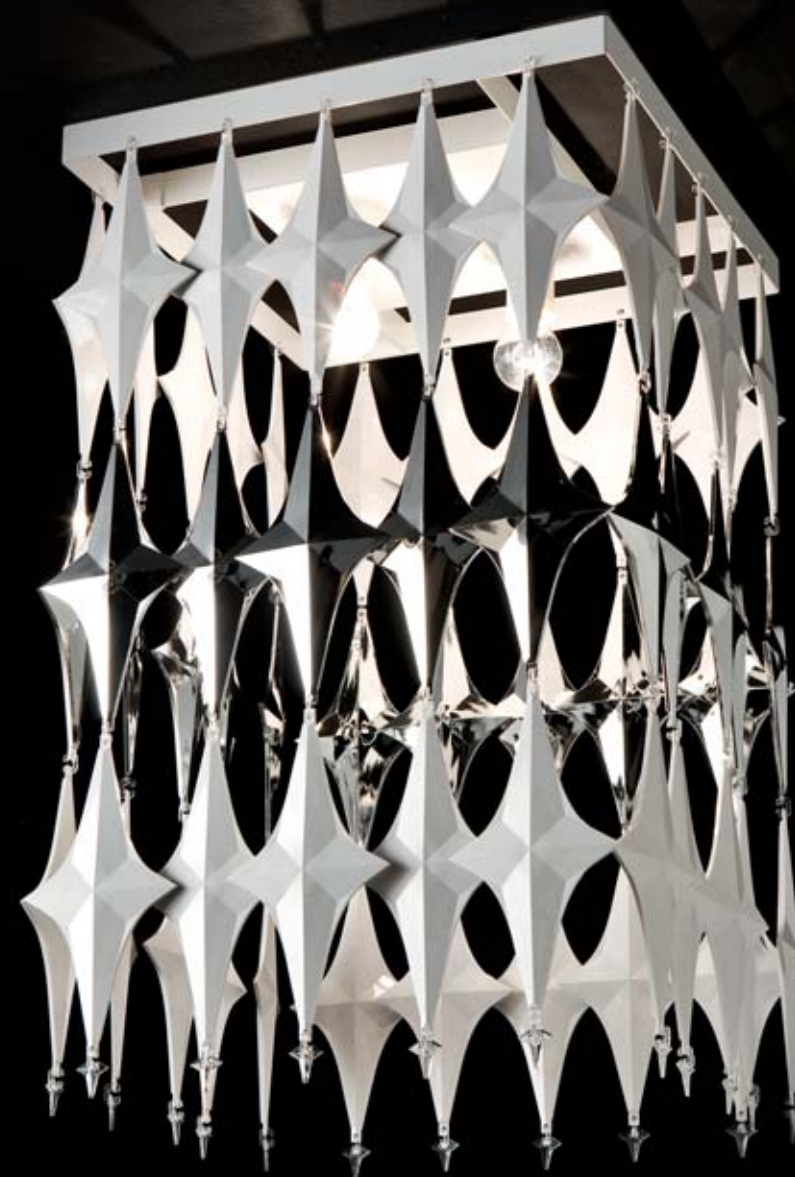

MR. E _ PL 120
PLAFONIERA MODULARE IN PMMA/
MODULAR CEILING LAMP IN PMMA

DESIGN STUDIO LUNICA, 2010

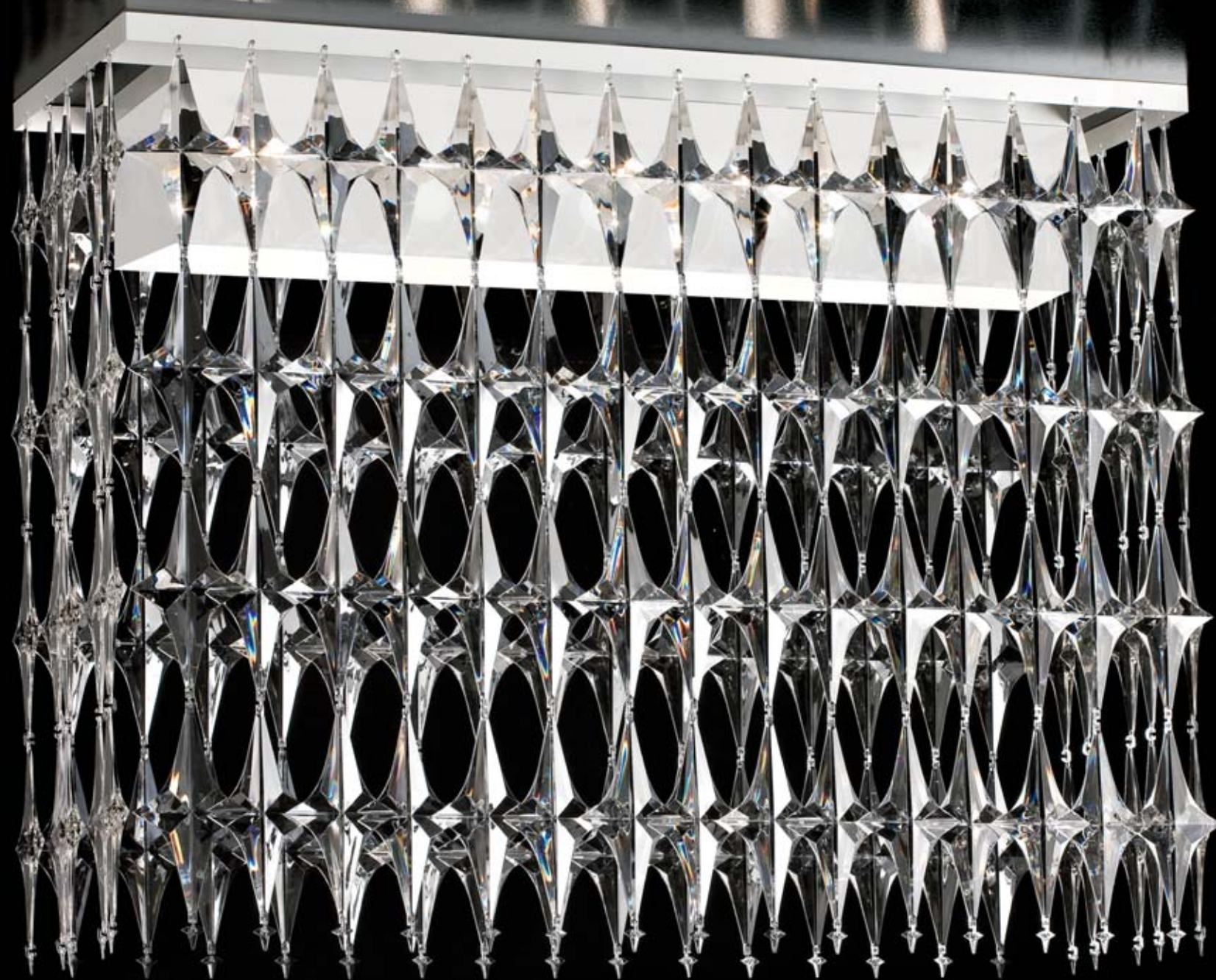

MR. E _ AP
**APPLIQUE MODULARE IN PMMA/
MODULAR WALL LAMP IN PMMA**

DESIGN STUDIO LUNICA, 2010





Diffusore componibile in pmma realizzato con elementi nei colori: cristallo, bianco, oro, cromo. Montatura in metallo bianco.

Modular diffuser in PMMA comprising elements in the following colours: crystal, white, gold and chrome. Fixture in white metal.

- 75W E27 ●
- 15W E27 ●
- 100W E27 ●
- 30W E27 ●

AP

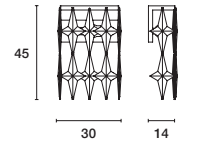

1 x ● or 1 x ●

PL 40

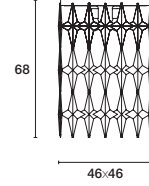

2 x ● or 2 x ●

PL 60

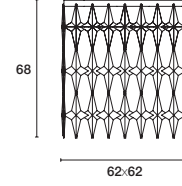

3 x ● or 3 x ●

PL 80

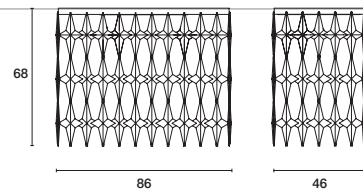

3 x ● or 3 x ●

PL 120

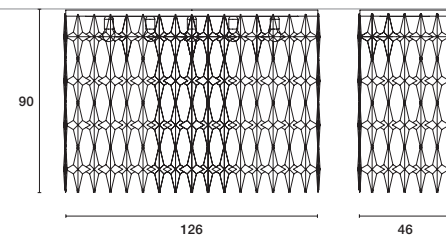

5 x ● or 5 x ●

SO 40

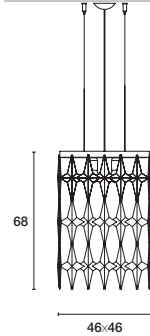

2 x ● or 2 x ●

SO 60

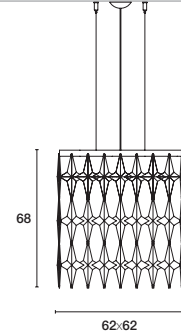

3 x ● or 3 x ●

SO 80

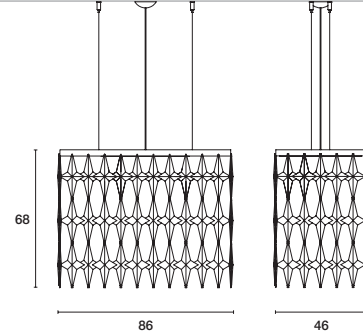

3 x ● or 3 x ●

SO 120

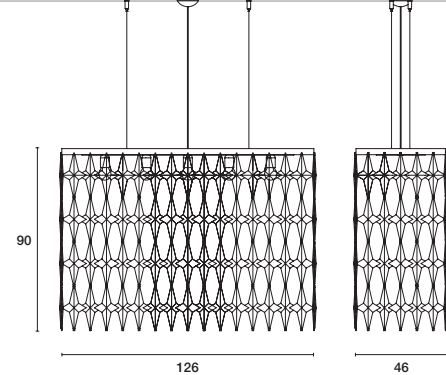

5 x ● or 5 x ●

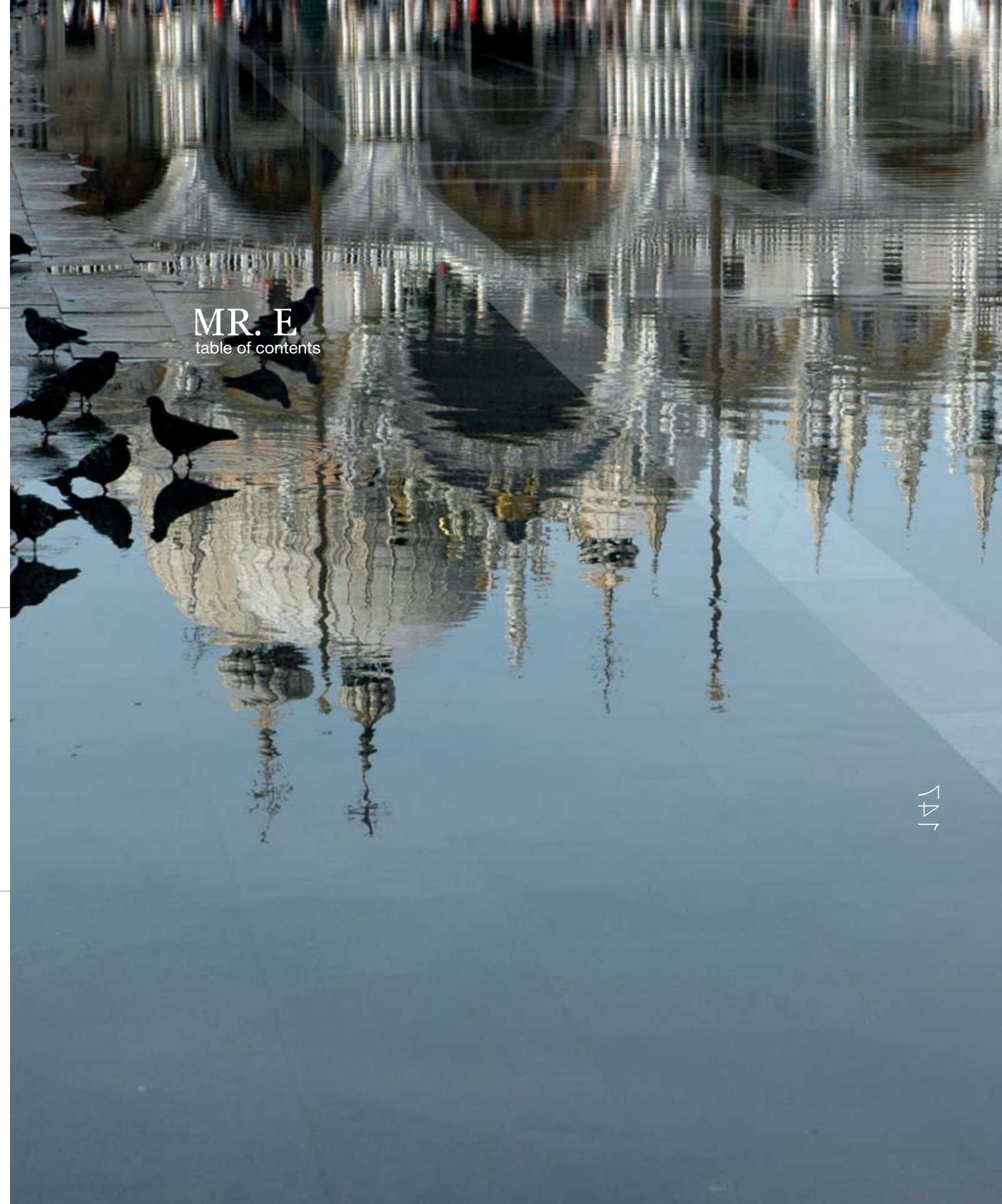

FV_60
**PLAFONIERA DA INCASSO/
BUILT-IN CEILING LAMP**

DESIGN VIALE 34, 2009

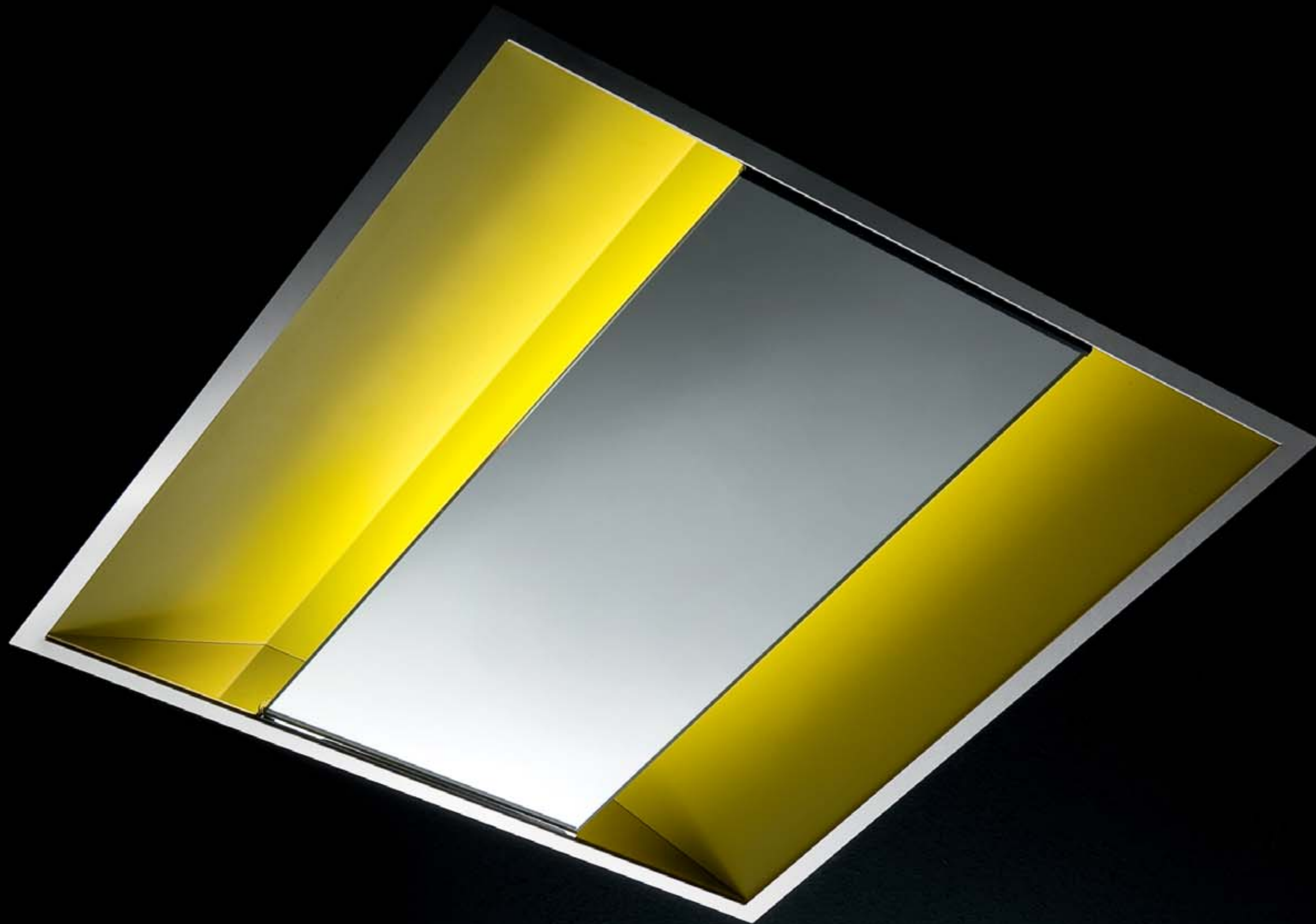

FV_60
**PLAFONIERA DA INCASSO/
BUILT-IN CEILING LAMP**

DESIGN VIALE 34, 2009





FV_25
**APPLIQUE DA INCASSO/
BUILT-IN WALL LAMP**

DESIGN VIALE 34, 2009



FV_40
**APPLIQUE DA INCASSO/
BUILT-IN WALL LAMP**

DESIGN VIALE 34, 2009







FV_10
**FARI DA INCASSO/
BUILT-IN SPOTLIGHTS**

DESIGN VIALE 34, 2009

FV_10
**FARI DA INCASSO/
BUILT-IN SPOTLIGHTS**
DESIGN VIALE 34, 2009



Lampada ad incasso da parete e soffitto. Built-in wall and ceiling lamp.
 Montatura metallo bianco opaco, nero opaco, inox lucido. Fixture in matt white metal, matt black or polished stainless steel.
 Parabola bianca, gialla, foglia oro, foglia argento. Parabolic louver in white, yellow, gold leaf or silver leaf.
 Diffusore in vetro piano o curvo nei colori nero lucido, bianco lucido o specchio. Diffuser in flat or curved glass in the following colours: gloss black, gloss white or mirror finish.

- 35W GU 5.3 MR16 12V 
- 150W R7s 114 mm 
- 24W 2G10 
- 55W 2G11 
- 50W GU10 

FV10/90°

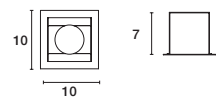

1 x 

FV10/45°

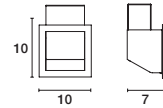

1 x 

FV25

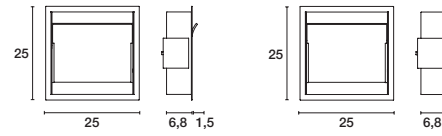

1 x  or 1 x 

FV40

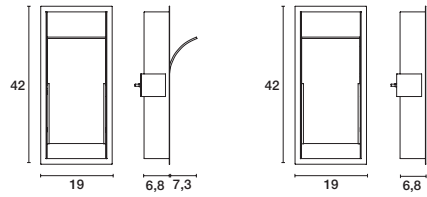

1 x  or 1 x 

FV60

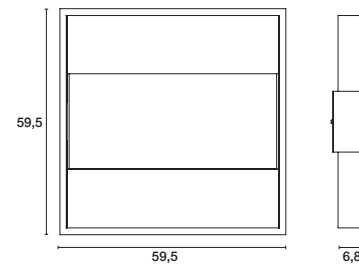

1 x 

**OUTER CASING
FV10**

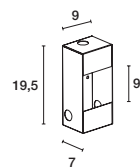

**OUTER CASING
FV25**

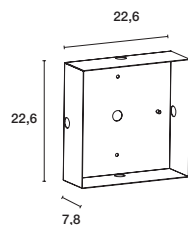

**OUTER CASING
FV40**

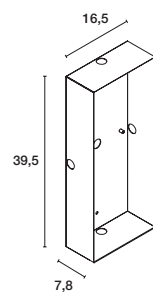

**OUTER CASING
FV60**

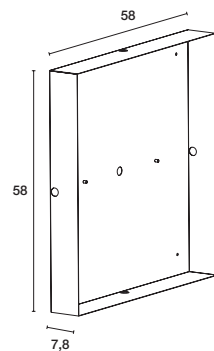

FV
table of contents



NOT ONLY DESIGN

Venice is inspiration, colours and tradition.
Façon de Venise is modern, original and exuberant:
new sources of light are inspired by the bustling places of a timeless city.

E NON SOLO
DESIGN

DESIGN
E NON SOLO

Venezia è ispirazione, colori e storia.
Façon de Venise è giovane, originale, esuberante:
nuove esperienze di luce nascono dall'incontro con i luoghi più vivi
di una città senza tempo.



CLAUDE

design lorenzo bertocco



CLAUDE _ S
TUBI LUMINOSI IN PIREX/
LUMINOUS TUBES IN PYREX

DESIGN LORENZO BERTOCCO, 2009



CLAUDE _ S
TUBI LUMINOSI IN PIREX/
LUMINOUS TUBES IN PYREX

DESIGN LORENZO BERTOCCO, 2009





CLAUDE _ AP
**TUBI LUMINOSI IN PIREX/
LUMINOUS TUBES IN PYREX**
DESIGN LORENZO BERTOCCO, 2009

CLAUDE _ S
**TUBI LUMINOSI IN PIREX/
LUMINOUS TUBES IN PYREX**
DESIGN LORENZO BERTOCCO, 2009

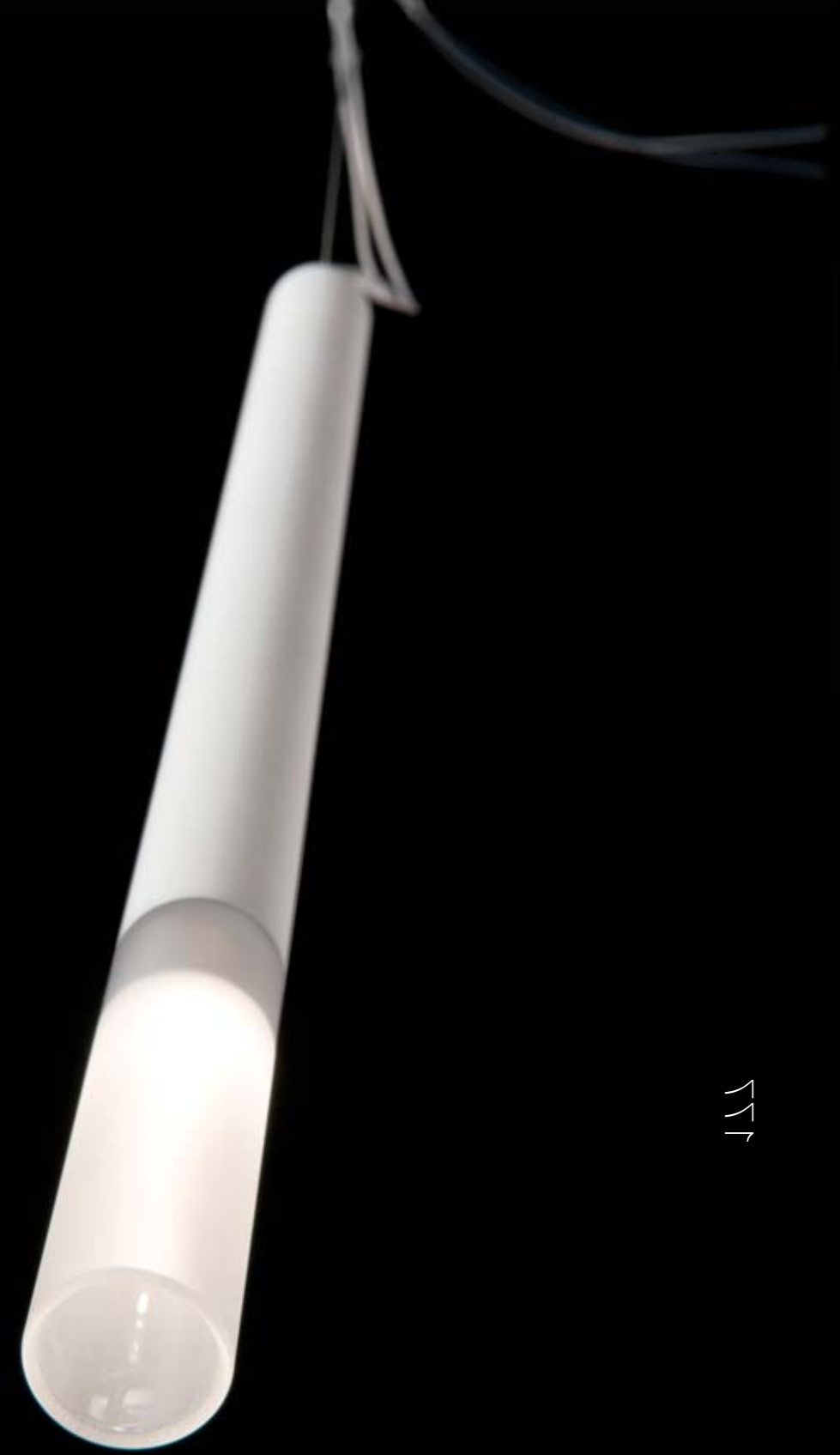

CLAUDE _ S
**TUBI LUMINOSI IN PIREX/
LUMINOUS TUBES IN PYREX**

DESIGN LORENZO BERTOCCO, 2009





Diffusore in vetro nei colori: bianco gesso con terminale cristallo satinato o nero grafite con terminale cristallo satinato. Montatura in metallo cromo.
Glass diffuser in the following colours: chalky white with end element in satin crystal glass, or graphite black with end element in satin crystal glass. Fixture in chrome-plated metal.

35W GY 6.35 12V 

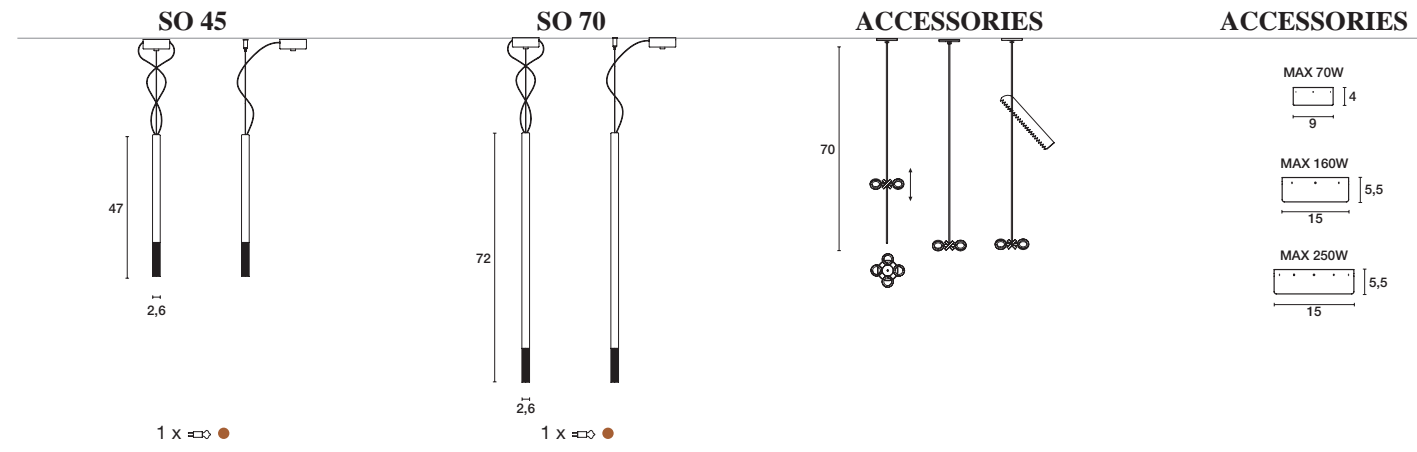

COMPOSITION 1

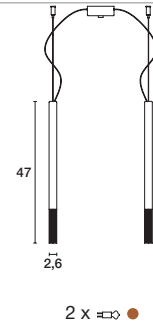

COMPOSITION 2

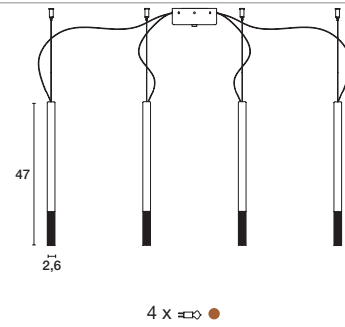

COMPOSITION 3

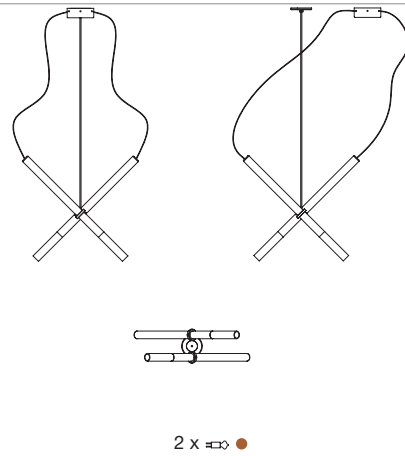

COMPOSITION 4

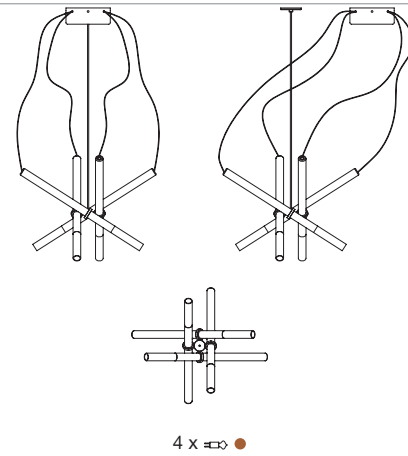

CLAUDE
table of contents

DISH design andrea lazzari



DISH
LAMPADA A SPECCHIO RGB/
RGB MIRROR LAMP

DESIGN ANDREA LAZZARI, 2010

DISH
LAMPADA A SPECCHIO RGB/
RGB MIRROR LAMP

DESIGN ANDREA LAZZARI, 2010



**DISH
LAMPADA A SPECCHIO/
MIRROR LAMP**

DESIGN ANDREA LAZZARI, 2010

"CENTRALE" LOUNGE BAR _ S. MARCO / VENICE _ 3.05 PM

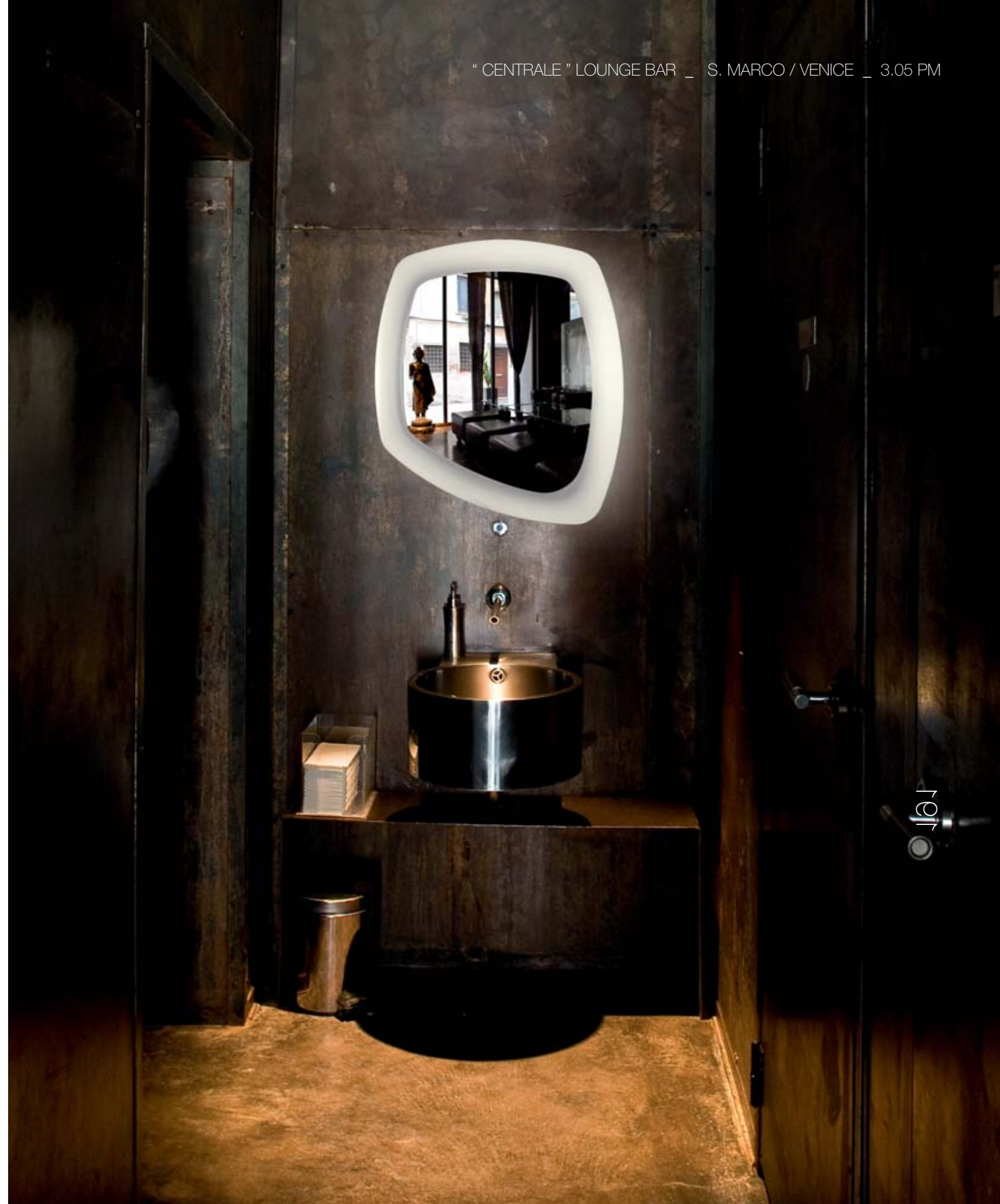





" PONTE DEI FRARI " _ VENICE _ 6.45 PM



DISH _ AP
APPLIQUE IN METACRILATO TERMOCURVATO /
WALL LAMP IN HEAT-BENT METHACRYLATE

DESIGN ANDREA LAZZARI, 2010

DISH_PL
**PLAFONIERA IN METACRILATO TERMOCURVATO/
CEILING LAMP IN HEAT-BENT METHACRYLATE**

DESIGN ANDREA LAZZARI, 2010



DISH
design andrea lazzari

Diffusore in metacrilato bianco lucido
o bianco lucido con specchio.
Montatura in metallo bianco, particolari in cromo.

Diffuser in gloss white methacrylate
or white with mirror finish.
Fixture in white metal
with chrome-plated details.

55W 2GX13
15W E27



TELECOMANDO RGB
RGB REMOTE CONTROL

DISH
table of contents

MI 60

AP/PL 60

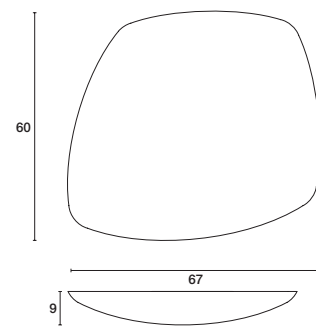
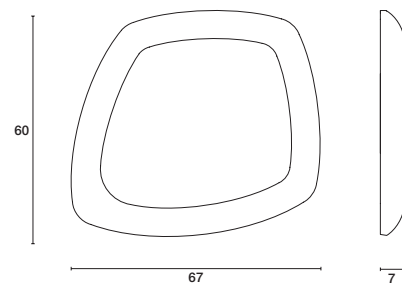

1 x ●
or 1 x ● + RGB LED STRIP 7W + REMOTE CONTROL
or RGB LED STRIP 7W + REMOTE CONTROL

3 x ● or 1 x ●

LUCI IN SCENA

FOCUSING ON LIGHTS

Discovering paths, illuminating interiors,
mixing and interpreting traditions:
Façon de Venise brings light and character to any space.
Contamination, expression and composition:
just close your eyes for a new attractive setting.

LUCI IN SCENA

Percorsi da scoprire, ambienti da illuminare,
intrecci e rappresentazioni di storie:
Façon de Venise anima di luce e personalità ogni spazio.

Contaminazione, dialogo, composizione:
per una nuova suggestiva scena
ora basta solo chiudere gli occhi.

façon de venise by

LIGHT4

LIGHT4 srl via noalese, 60 - 31055 quinto di treviso (tv) - italia
t. +39 0422 378122 - t. +39 0422 475009 - f +39 0422 370409
www.facondevenise.com - www.light4.it - info@light4.it

